

Zubehörteile

Accessories

Accessoires

– weishaupt –

Inhalt	Seite	Table of contents	Page	Repertoire	Page
1. Zubehör Ölbrenner		1. Oil burner accessories		1. Accessoires brûleurs fioul	
1.1 Heizöl-Filter	4	1.1 Fuel oil filters	5	1.1 Filtre fioul	5
1.2 Öl-Absperrorgane	8	1.2 Oil shut-off devices	9	1.2 Organe d'isolement fioul	9
1.3 Gas-Luft-Abscheider	12	1.3 Air/gas-separators	13	1.3 Séparateur air-gaz	13
1.4 Begleitheizung	12	1.4 Line heating	13	1.4 Réchauffage d'accompagnement	13
1.5 Ölzähleinrichtungen	14	1.5 Oil meters	15	1.5 Comptage fioul	15
1.6 Ringleitungsarmaturen	18	1.6 Ring main fittings	19	1.6 Accessoires boucles de transfert	19
1.7 Einstrangarmaturen/Heizöllecker- melder	24	1.7 Single pipe fittings/ oil leakage alarm	25	1.7 Pompe monotube/ Indicateur fuite de fioul	25
2. Zubehör Gasbrenner		2. Gas burner accessories		2. Accessoires brûleurs gaz	
2.1 Kugelhähne	26	2.1 Ball cocks	27	2.1 Robinets à bille	27
2.2 Thermische Absperrreinrichtung Flammenrückschlagsicherung	28	2.2 Thermal shut off device Flame trap	29	2.2 Soupape de fermeture thermique Dispositif anti-retour de flamme	29
2.3 Gasfilter	28	2.3 Gas filters	29	2.3 Filtre gaz	29
2.4 Gaszähler	30	2.4 Gas meters	31	2.4 Comptage gaz	31
2.5 Druckregelgeräte	32	2.5 Gas governors	33	2.5 Régulateurs de pression	33
2.6 Manometer, Prüfbrenner	40	2.6 Pressure gauges, test burners	41	2.6 Manomètre-brûleur test	41
2.7 Dichtheitskontrolle und Magnetventil für Leckgas Gasschläuche WG-Brenner	44	2.7 Valve proving and vent gas solenoid valve Gas hoses, WG burners	45	2.7 Contrôle d'étanchéité vanne magnétique de mise à l'air libre Flexible gaz pour brûleur WG	45
2.8 Kompensatoren und Verbindungssteile	46	2.8 Compensators and connecting parts	47	2.8 Compensateur et pièces de raccordement	47
2.9 Armaturen-Abstützung, Distanzringe, Zwischenflansche	56	2.9 Valve train support, spacer rings, Intermediate flange	57	2.9 Support de rampe, entretoises, brides intermédiaires	57
2.9 Ansaugflansch Fremdluftansaugung	58	2.9 Intake flange ducted air intake	59	2.9 Bride d'aspiration air extérieur	59
3. Gewebekompensatoren/ Dichtschnur	58	3. Textile compensators/ sealing cord	59	3. Manchette souple/ cordon d'isolation	59
4. Regler/Digital-Anzeigergerät		4. Controller/Digital display unit		4. Régulateur à affichage digital	
4.1 Regelsystem KS40-108 Regelsystem KS40-102	60	4.1 Control system KS40-108 Control system KS40-102	61	4.1 Système KS40-108 Système KS40-102	61
4.2 Digital-Anzeigergeräte	62	4.2 Digital indicating equipment	63	4.2 Indicateur digital	63
5. Dampfdruckwächter		5. System pressure switches		5. Pressostat	
5.1 Niederdruck bis 0,5 bar	64	5.1 Low pressure up to 0.5 bar	65	5.1 Basse pression jusqu'à 0,5 bar	65
5.2 Hochdruck über 0,5 bar	64	5.2 High pressure above 0.5 bar	65	5.2 Haute pression supér. à 0,5 bar	65
5.3 Heißwasser-Minimal-Druck	64	5.3 Hot water- minimum pressure	65	5.3 Pression minimale eau surchauffée	65
6. Meß- und Prüfgeräte	66	6. Measuring and testing equipment	67	6. Appareillage de mesure et de contrôle	67
7. Werkzeuge	68	7. Tools	69	7. Outillage	69
8. Zubehör für BUS-Systeme	70	8. Accessories for BUS systems	71	8. Accessoires pour systèmes BUS	71

– weishaupt –

In dieser neuen Weishaupt-Zubehörteilliste finden Sie ein Angebot erstklassiger, geprüfter Zubehörteile für Öl- und Gasfeuerungsanlagen.

Die zentrale Zusammenfassung aller Zubehörteile in dieser Liste macht es möglich, auf die Aufführung von Zubehörteilen in den Brennerprospekten zu verzichten.

Alle Zubehörteile die in Verbindung mit Weishaupt-Brennern benötigt werden, sind in dieser Liste erfaßt.

Die besonderen Vorteile unseres Angebotes sollten Sie beim Einkauf Ihrer Zubehörteile nicht unberücksichtigt lassen:

- Weishaupt-Qualitätsmaßstäbe bei der Auswahl aller Teile garantieren Güte und Funktion.
- Sie haben einen einzigen Lieferanten für Brenner und Zubehör. Und nur einen, der die Verantwortung für alles trägt. Dazu sparen Sie durch die vereinfachte Abwicklung.
- Sie benötigen keine eigene teure Lagerhaltung. Das übernimmt Weishaupt für Sie.

Bitte geben Sie bei der Bestellung an:

Stückzahl _____

Bezeichnung _____

Bestell-Nr. _____

Preis _____

Liefertermin _____

Brennertyp _____

Fabriknummer _____

This new Weishaupt accessories list offers first rate, tested accessories for oil and gas fired installations.

By compiling all the accessories available for Weishaupt burners in this list, it is not necessary to list additional parts in the burner brochures.

You should not overlook the particular advantages of purchasing your accessories from us:

- Parts are selected in accordance with Weishaupt's quality standards, ensuring worthiness and reliability.
- A single supplier for burners and additional parts simplifies your ordering process and means there is only one supplier who is responsible for everything.
- No need for expensive storage facilities for accessories – Weishaupt takes care of that for you.

Please include the following details with your order:

Quantity required _____

Description _____

Order No. _____

Price _____

Required delivery date _____

Burner type _____

Serial-No. _____

Dans cette liste d'accessoires Weishaupt, vous trouverez une offre d'accessoires éprouvés et de qualité pour installations de combustion au fioul et au gaz.

Le rassemblement de tous accessoires dans cette liste, nous permet d'omettre ces accessoires dans les brochures concernant les brûleurs mêmes.

Tous les accessoires nécessaires aux brûleurs Weishaupt, figurent dans cette liste.

Profitez des avantages de notre offre lors de vos achats d'accessoires:

- La qualité et le fonctionnement de tous ces accessoires sont garantis par les normes de qualité Weishaupt.
- un seul fournisseur pour le brûleur et les accessoires, donc une seule firme responsable des appareils. Un système simple et économique.
- pas de stockage coûteux. Weishaupt le fait pour vous.

Veillez indiquer lors de votre commande:

Nombre de pièces _____

Dénomination _____

Numéro de commande _____

Prix _____

Délai de livraison _____

Type brûleur _____

No de fabrication _____

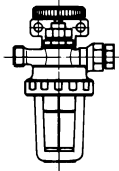

1.101



1.102

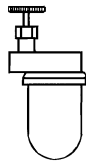

1.103

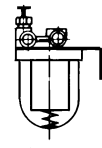
1.104
1.105

Nr.	Bezeichnung	Bestell-Nr. Order No. N° de commande	Preis EUR (o. MwSt.)
1.	Zubehör Ölbrenner		
	<p>Auswahl der Heizölfilter Bei der Auswahl der Heizölfilter ist folgendes zu beachten:</p> <p>Einstranginstallation: Bei der Einstranginstallation muss der Filter nach dem maximalen Öldurchsatz des Brenners ausgelegt werden.</p> <p>Zweistranginstallation: Bei der Zweistranginstallation muss die maximale Pumpenfördermenge zugrunde gelegt werden.</p> <p>Siehe auch Weishaupt Arbeitsmappe – Technische Arbeitsblätter 2.4: Arbeitsblatt 6-2.1 Dimensionierung von Heizölleitungen Arbeitsblatt 7-1.4 Blatt 1 Armaturen für Öl; Weishaupt-Filter für Heizöl EL Arbeitsblatt 7-1.4 Blatt 2 Armaturen für Öl; Weishaupt-Filter für Heizöl M und S mit Heizpatrone Arbeitsblatt 7-1.4 Blatt 3 Armaturen für Öl; Weishaupt-Filter für Heizöl M und S mit Stellantrieb und Heizpatrone Arbeitsblatt 7-1.5 Blatt 1 Armaturen für Öl; Brenner-Pumpen-Fördermengen Arbeitsblatt 7-1.5 Blatt 2 Armaturen für Öl; Brenner-Pumpen-Fördermengen</p>		
	1.1 Heizöl-Filter		
	Einstrangfilter		
1.101	<p>Filter V 500 Si, für Einstrangbetrieb mit Befestigungswinkel; Sinterkunststoffsieb 50 µ; Filtertasse aus durchsichtigem Kunststoff Anschlüsse: tankseitig: 1 x G3/8 i mit Universalverschraubung für Rohr 8, 10 oder 12 mm brennerseitig: 1 x G3/8 a für Schlauchanschluss Durchflussmenge: 250 l/h Betriebstemperatur: max. 40° C nur für Saugbetrieb geeignet</p>	493 370	
1.102	<p>Filter V 1/2 - 500 St, für Einstrangbetrieb mit Befestigungswinkel; Edstahlsieb 100µ; Filtertasse aus durchsichtigem Kunststoff Anschlüsse: tankseitig: 1 x G1/2 i brennerseitig: 1 x G1/2 i Durchflussmenge: 560 l/h Betriebstemperatur: max. 40° C nur für Saugbetrieb geeignet</p>	493 403	
1.103	<p>Filter V 1/2 - 500 St, für Einstrangbetrieb mit Befestigungswinkel; Edstahlsieb 100µ; Filtertasse aus Messing Anschlüsse: tankseitig: 1 x G1/2 i brennerseitig: 1 x G1/2 i Durchflussmenge: 560 l/h Betriebstemperatur: max. 60° C für Saugbetrieb und für Zulaufbetrieb bis 6 bar geeignet</p>	493 397	
	Zweistrangfilter		
1.104	<p>Filter Z 3/8 500 St, für Zweistrangbetrieb mit Befestigungswinkel; Edstahlsieb 100µ; Filtertasse aus durchsichtigem Kunststoff Anschlüsse: tankseitig: 2 x G3/8 i mit 2 x Universalverschraubung für Rohr 8, 10 oder 12 mm brennerseitig: 2 x G3/8 a für Schlauchanschluss Durchflussmenge: 220 l/h Betriebstemperatur: max. 40° C nur für Saugbetrieb geeignet</p>	493 388	
1.105	<p>Filter Z 1/2 - 500 St, für Zweistrangbetrieb mit Befestigungswinkel; Edstahlsieb 100µ; Filtertasse aus durchsichtigem Kunststoff Anschlüsse: tankseitig: 2 x G1/2 i brennerseitig: 2 x G1/2 i Durchflussmenge: 500 l/h Betriebstemperatur: max. 40° C nur für Saugbetrieb geeignet</p>	493 383	
	<p>Die Durchflussmengen der o.g. Filter beziehen sich auf ein Δp von 100 mbar bei 50%igem Verschmutzungsgrad des Filtereinsatzes.</p>		
	<p>Anschlusssteile bei Bedarf: Einschraubstutzen G3/8 a x G3/8 a für Schlauchanschluss Einschraubstutzen G1/2 a x G1/2 a für Schlauchanschluss Einschraubstutzen G1/2 a x M30 x 1,5 a für Schlauchanschluss Reduzierstutzen G1/2 a x G3/8 i Dichtring A17 x 21 x 1,5 für G3/8 Dichtring A21 x 26 x 1,5 für G1/2</p>	<p>111 011 0006 7 111 512 0003 7 112 654 0001 7 210 153 0614 7 440 003 440 020</p>	

No.	Description										
1.	<p>Oil burner accessories</p> <p>Selection of fuel oil filters The following should be observed when selecting the fuel oil filters:</p> <p>Single pipe installations: On single pipe installations the filter has to be suitable for the maximum oil throughput of the burner.</p> <p>Two pipe installations: On two pipe installations the filter must be suitable for the maximum pump capacity.</p> <p>See also Weishaupt work folder - technical work sheets 2.4: Work sheet 6-2.1 Dimensioning of fuel oil lines Work sheet 7-1.4 sheet 1 Fittings for oil, Weishaupt filter for oil EL Work sheet 7-1.4 sheet 2 Fittings for oil, Weishaupt filter for oil M, S Work sheet 7-1.4 sheet 3 Fittings for oil, Weishaupt filter for oil M, S Work sheet 7-1.5 sheet 1 Fittings for oil, burner pump capacities Work sheet 7-1.5 sheet 2 Fittings for oil, burner pump capacities</p>										
1.1	<p>Fuel oil filters</p> <p>Single pipe filter</p> <tr> <td>1.101</td> <td> <p>Single pipe filter V500 Si with fixing bracket; sinter plastic strainer 50 µ; clear plastic sediment bowl Connections: tank side: 1 x G3/8 f w. adaptor for 8, 10 or 12 mm pipe burner side: 1 x G3/8 m for hose connection Capacity: 250 l/h Max. operating temperature: max. 40 °C only suitable for gravity operation</p> </td> </tr> <tr> <td>1.102</td> <td> <p>Filter V 1/2 - 500 St, for single pipe operation with fixing bracket; stainless steel strainer 100 µ; clear plastic sediment bowl Connection: tank side: 1 x G1/2f burner side: 1 x G1/2f Capacity: 560 l/h Operating temperature: max. 40 °C only suitable for gravity operation</p> </td> </tr> <tr> <td>1.103</td> <td> <p>Filter V 1/2- 500 ST, for single pipe operation with fixing bracket; stainless steel strainer 100 µ; brass sediment bowl Connection: tank side: 1 x G1/2f burner side: 1 x G1/2f Capacity: 560 l/h Operating temperature: max. 60 °C suitable for pressure up to 6 bar</p> <p>Two pipe installation</p> </td> </tr> <tr> <td>1.104</td> <td> <p>Filter Z 3/8 500 St, for two pipe operation with fixing bracket; stainless steel strainer 100 µ; clear plastic sediment bowl Connections: tank side: 1 x G3/8 f w. adaptor for 8, 10 or 12 mm pipe burner side: 1 x G3/8m for hose connection Capacity: 220 l/h Max. operating temperature: max. 40 °C only suitable for gravity operation</p> </td> </tr> <tr> <td>1.105</td> <td> <p>Filter Z 1/2 500 St, for two pipe operation with fixing bracket; stainless steel strainer 100 µ; clear plastic sediment bowl Connection: tank side: 1 x G1/2f burner side: 1 x G1/2f Capacity: 500 l/h Operating temperature: max. 40 °C only suitable for gravity operation</p> <p>The capacities of the above filters relate to an Δp of 100 mbar with 50 % fouled filter</p> <p>Connection parts available: Threaded socket G3/8 m x G3/8 m for hose connection Threaded socket G1/2 m x G1/2 m for hose connection Threaded socket G1/2 m x M30 x 1.5 m for hose connection Reducing nipple G1/2 m x G3/8 f Sealing ring A17 x 21 x 1.5 for G3/8 Sealing ring A21 x 26 x 1.5 for G1/2</p> </td> </tr>	1.101	<p>Single pipe filter V500 Si with fixing bracket; sinter plastic strainer 50 µ; clear plastic sediment bowl Connections: tank side: 1 x G3/8 f w. adaptor for 8, 10 or 12 mm pipe burner side: 1 x G3/8 m for hose connection Capacity: 250 l/h Max. operating temperature: max. 40 °C only suitable for gravity operation</p>	1.102	<p>Filter V 1/2 - 500 St, for single pipe operation with fixing bracket; stainless steel strainer 100 µ; clear plastic sediment bowl Connection: tank side: 1 x G1/2f burner side: 1 x G1/2f Capacity: 560 l/h Operating temperature: max. 40 °C only suitable for gravity operation</p>	1.103	<p>Filter V 1/2- 500 ST, for single pipe operation with fixing bracket; stainless steel strainer 100 µ; brass sediment bowl Connection: tank side: 1 x G1/2f burner side: 1 x G1/2f Capacity: 560 l/h Operating temperature: max. 60 °C suitable for pressure up to 6 bar</p> <p>Two pipe installation</p>	1.104	<p>Filter Z 3/8 500 St, for two pipe operation with fixing bracket; stainless steel strainer 100 µ; clear plastic sediment bowl Connections: tank side: 1 x G3/8 f w. adaptor for 8, 10 or 12 mm pipe burner side: 1 x G3/8m for hose connection Capacity: 220 l/h Max. operating temperature: max. 40 °C only suitable for gravity operation</p>	1.105	<p>Filter Z 1/2 500 St, for two pipe operation with fixing bracket; stainless steel strainer 100 µ; clear plastic sediment bowl Connection: tank side: 1 x G1/2f burner side: 1 x G1/2f Capacity: 500 l/h Operating temperature: max. 40 °C only suitable for gravity operation</p> <p>The capacities of the above filters relate to an Δp of 100 mbar with 50 % fouled filter</p> <p>Connection parts available: Threaded socket G3/8 m x G3/8 m for hose connection Threaded socket G1/2 m x G1/2 m for hose connection Threaded socket G1/2 m x M30 x 1.5 m for hose connection Reducing nipple G1/2 m x G3/8 f Sealing ring A17 x 21 x 1.5 for G3/8 Sealing ring A21 x 26 x 1.5 for G1/2</p>
1.101	<p>Single pipe filter V500 Si with fixing bracket; sinter plastic strainer 50 µ; clear plastic sediment bowl Connections: tank side: 1 x G3/8 f w. adaptor for 8, 10 or 12 mm pipe burner side: 1 x G3/8 m for hose connection Capacity: 250 l/h Max. operating temperature: max. 40 °C only suitable for gravity operation</p>										
1.102	<p>Filter V 1/2 - 500 St, for single pipe operation with fixing bracket; stainless steel strainer 100 µ; clear plastic sediment bowl Connection: tank side: 1 x G1/2f burner side: 1 x G1/2f Capacity: 560 l/h Operating temperature: max. 40 °C only suitable for gravity operation</p>										
1.103	<p>Filter V 1/2- 500 ST, for single pipe operation with fixing bracket; stainless steel strainer 100 µ; brass sediment bowl Connection: tank side: 1 x G1/2f burner side: 1 x G1/2f Capacity: 560 l/h Operating temperature: max. 60 °C suitable for pressure up to 6 bar</p> <p>Two pipe installation</p>										
1.104	<p>Filter Z 3/8 500 St, for two pipe operation with fixing bracket; stainless steel strainer 100 µ; clear plastic sediment bowl Connections: tank side: 1 x G3/8 f w. adaptor for 8, 10 or 12 mm pipe burner side: 1 x G3/8m for hose connection Capacity: 220 l/h Max. operating temperature: max. 40 °C only suitable for gravity operation</p>										
1.105	<p>Filter Z 1/2 500 St, for two pipe operation with fixing bracket; stainless steel strainer 100 µ; clear plastic sediment bowl Connection: tank side: 1 x G1/2f burner side: 1 x G1/2f Capacity: 500 l/h Operating temperature: max. 40 °C only suitable for gravity operation</p> <p>The capacities of the above filters relate to an Δp of 100 mbar with 50 % fouled filter</p> <p>Connection parts available: Threaded socket G3/8 m x G3/8 m for hose connection Threaded socket G1/2 m x G1/2 m for hose connection Threaded socket G1/2 m x M30 x 1.5 m for hose connection Reducing nipple G1/2 m x G3/8 f Sealing ring A17 x 21 x 1.5 for G3/8 Sealing ring A21 x 26 x 1.5 for G1/2</p>										

No.	Dénomination										
1.	<p>Accessoires brûleur fioul</p> <p>Détermination des filtres fioul Lors de la détermination des filtres fioul, il convient de tenir compte des éléments ci-après :</p> <p>Installation mono-tube: Pour une installation en mono-tube, le filtre doit être déterminé en fonction du débit maximal du brûleur.</p> <p>Installation bi-tubes : Pour une installation en bi-tubes, il faut déterminer le débit maximal de la pompe.</p> <p>Voir également le recueil de fiches techniques 2.4 : Fiche technique 6-2.1 Dimensionnement des conduites fioul Fiche technique 7-1.4 feuille 1 Accessoires fioul; Filtres Weishaupt pour FOD Fiche technique 7-1.4 feuille 2 Accessoires fioul; Filtres pour fiouls léger et lourd avec cartouche chauffante Fiche technique 7-1.4 feuille 3 Accessoires fioul; Filtres pour fiouls léger et lourd avec servomoteur et cartouche chauffante Fiche technique 7-1.5 feuille 1 Accessoires fioul; Brûleurs-Pompes-Débit nécessaire Fiche technique 7-1.5 feuille 2 Accessoires fioul; Brûleurs-Pompes-Débit nécessaire</p>										
1.1	<p>Filtres fioul</p> <p>Filtre mono-tube</p> <tr> <td>1.101</td> <td> <p>Filtre V 500 Si, pour fonctionnement en mono-tube avec équerre de fixation ; filtre fritté 50 µ ; pot plastique transparent Raccord. : côté cuve : 1 x G3/8 i avec raccord univ. pour tube 8, 10 ou 12 mm côté brûleur : 1 x G3/8 a pour raccordement flexibles Débit : 250 l/h Température de fonctionnement : max. 40 °C uniquement adapté pour fonctionnement en aspiration</p> </td> </tr> <tr> <td>1.102</td> <td> <p>Filtre V 1/2 - 500 St, pour fonctionnement en mono-tube avec équerre de fixation ; filtre inox 100 µ ; pot plastique transparent Raccordements : côté cuve : 1 x G1/2 i côté brûleur : 1 x G1/2 i Débit : 560 l/h Température de fonctionnement : max. 40 °C uniquement adapté pour fonctionnement en aspiration</p> </td> </tr> <tr> <td>1.103</td> <td> <p>Filtre V 1/2 - 500 St, pour fonctionnement en mono-tube avec équerre de fixation ; filtre inox 100 µ ; pot en laiton Raccordements : côté cuve : 1 x G1/2 i côté brûleur : 1 x G1/2 i Débit : 560 l/h Température de fonctionnement : max. 60 °C adapté pour fonctionnement en aspiration et sous pression jusqu'à 6 bar</p> <p>Filtre bi-tubes</p> </td> </tr> <tr> <td>1.104</td> <td> <p>Filtre Z 3/8 500 St, pour fonctionnement en bi-tubes avec équerre de fixation ; filtre inox 100 µ ; pot plastique transparent Racc. : côté cuve : 2 x G3/8 i avec 2 x raccord univ. pour tube 8, 10 ou 12 mm côté brûleur: 2 x G3/8 a pour raccordement flexibles Débit : 220 l/h Température de fonctionnement : max. 40 °C uniquement adapté pour fonctionnement en aspiration</p> </td> </tr> <tr> <td>1.105</td> <td> <p>Filtre Z 1/2 - 500 St, pour fonctionnement en bi-tubes avec équerre de fixation ; filtre inox 100 µ ; pot plastique transparent Raccordements : côté cuve : 2 x G1/2 i côté brûleur : 2 x G1/2 i Débit : 500 l/h Température de fonctionnement : max. 40 °C uniquement adapté pour fonctionnement en aspiration</p> <p>Les débits des filtres cités ci-dessus se rapportent à un Δp de 100 mbar pour un degré d'encrassement de 50 % de la cartouche filtrante</p> <p>Éléments de raccordement en cas de besoin : Mamelon G3/8 a x G3/8 a pour raccordement flexibles Mamelon G1/2 a x G1/2 a pour raccordement flexibles Mamelon G1/2 a x M30 x 1,5 a pour raccordement flexibles Réduction G1/2 a x G3/8 i Joint A17 x 21 x 1,5 pour G3/8 Joint A21 x 26 x 1,5 pour G1/2</p> </td> </tr>	1.101	<p>Filtre V 500 Si, pour fonctionnement en mono-tube avec équerre de fixation ; filtre fritté 50 µ ; pot plastique transparent Raccord. : côté cuve : 1 x G3/8 i avec raccord univ. pour tube 8, 10 ou 12 mm côté brûleur : 1 x G3/8 a pour raccordement flexibles Débit : 250 l/h Température de fonctionnement : max. 40 °C uniquement adapté pour fonctionnement en aspiration</p>	1.102	<p>Filtre V 1/2 - 500 St, pour fonctionnement en mono-tube avec équerre de fixation ; filtre inox 100 µ ; pot plastique transparent Raccordements : côté cuve : 1 x G1/2 i côté brûleur : 1 x G1/2 i Débit : 560 l/h Température de fonctionnement : max. 40 °C uniquement adapté pour fonctionnement en aspiration</p>	1.103	<p>Filtre V 1/2 - 500 St, pour fonctionnement en mono-tube avec équerre de fixation ; filtre inox 100 µ ; pot en laiton Raccordements : côté cuve : 1 x G1/2 i côté brûleur : 1 x G1/2 i Débit : 560 l/h Température de fonctionnement : max. 60 °C adapté pour fonctionnement en aspiration et sous pression jusqu'à 6 bar</p> <p>Filtre bi-tubes</p>	1.104	<p>Filtre Z 3/8 500 St, pour fonctionnement en bi-tubes avec équerre de fixation ; filtre inox 100 µ ; pot plastique transparent Racc. : côté cuve : 2 x G3/8 i avec 2 x raccord univ. pour tube 8, 10 ou 12 mm côté brûleur: 2 x G3/8 a pour raccordement flexibles Débit : 220 l/h Température de fonctionnement : max. 40 °C uniquement adapté pour fonctionnement en aspiration</p>	1.105	<p>Filtre Z 1/2 - 500 St, pour fonctionnement en bi-tubes avec équerre de fixation ; filtre inox 100 µ ; pot plastique transparent Raccordements : côté cuve : 2 x G1/2 i côté brûleur : 2 x G1/2 i Débit : 500 l/h Température de fonctionnement : max. 40 °C uniquement adapté pour fonctionnement en aspiration</p> <p>Les débits des filtres cités ci-dessus se rapportent à un Δp de 100 mbar pour un degré d'encrassement de 50 % de la cartouche filtrante</p> <p>Éléments de raccordement en cas de besoin : Mamelon G3/8 a x G3/8 a pour raccordement flexibles Mamelon G1/2 a x G1/2 a pour raccordement flexibles Mamelon G1/2 a x M30 x 1,5 a pour raccordement flexibles Réduction G1/2 a x G3/8 i Joint A17 x 21 x 1,5 pour G3/8 Joint A21 x 26 x 1,5 pour G1/2</p>
1.101	<p>Filtre V 500 Si, pour fonctionnement en mono-tube avec équerre de fixation ; filtre fritté 50 µ ; pot plastique transparent Raccord. : côté cuve : 1 x G3/8 i avec raccord univ. pour tube 8, 10 ou 12 mm côté brûleur : 1 x G3/8 a pour raccordement flexibles Débit : 250 l/h Température de fonctionnement : max. 40 °C uniquement adapté pour fonctionnement en aspiration</p>										
1.102	<p>Filtre V 1/2 - 500 St, pour fonctionnement en mono-tube avec équerre de fixation ; filtre inox 100 µ ; pot plastique transparent Raccordements : côté cuve : 1 x G1/2 i côté brûleur : 1 x G1/2 i Débit : 560 l/h Température de fonctionnement : max. 40 °C uniquement adapté pour fonctionnement en aspiration</p>										
1.103	<p>Filtre V 1/2 - 500 St, pour fonctionnement en mono-tube avec équerre de fixation ; filtre inox 100 µ ; pot en laiton Raccordements : côté cuve : 1 x G1/2 i côté brûleur : 1 x G1/2 i Débit : 560 l/h Température de fonctionnement : max. 60 °C adapté pour fonctionnement en aspiration et sous pression jusqu'à 6 bar</p> <p>Filtre bi-tubes</p>										
1.104	<p>Filtre Z 3/8 500 St, pour fonctionnement en bi-tubes avec équerre de fixation ; filtre inox 100 µ ; pot plastique transparent Racc. : côté cuve : 2 x G3/8 i avec 2 x raccord univ. pour tube 8, 10 ou 12 mm côté brûleur: 2 x G3/8 a pour raccordement flexibles Débit : 220 l/h Température de fonctionnement : max. 40 °C uniquement adapté pour fonctionnement en aspiration</p>										
1.105	<p>Filtre Z 1/2 - 500 St, pour fonctionnement en bi-tubes avec équerre de fixation ; filtre inox 100 µ ; pot plastique transparent Raccordements : côté cuve : 2 x G1/2 i côté brûleur : 2 x G1/2 i Débit : 500 l/h Température de fonctionnement : max. 40 °C uniquement adapté pour fonctionnement en aspiration</p> <p>Les débits des filtres cités ci-dessus se rapportent à un Δp de 100 mbar pour un degré d'encrassement de 50 % de la cartouche filtrante</p> <p>Éléments de raccordement en cas de besoin : Mamelon G3/8 a x G3/8 a pour raccordement flexibles Mamelon G1/2 a x G1/2 a pour raccordement flexibles Mamelon G1/2 a x M30 x 1,5 a pour raccordement flexibles Réduction G1/2 a x G3/8 i Joint A17 x 21 x 1,5 pour G3/8 Joint A21 x 26 x 1,5 pour G1/2</p>										

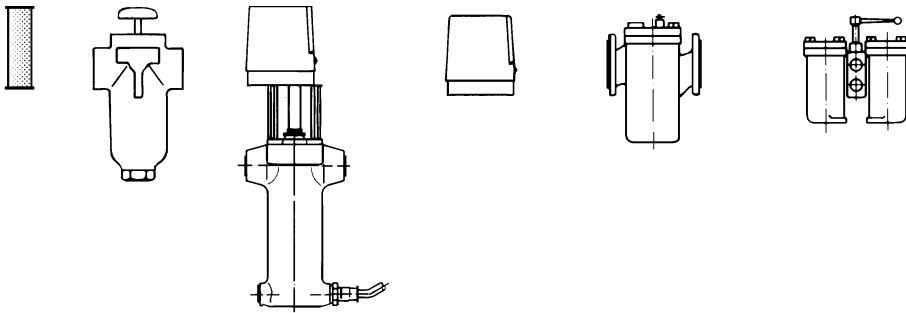

1.106 1.111 1.112 1.113 1.114 1.115

Nr.	Bezeichnung	Bestell-Nr. Order No. N° de commande	Preis EUR (o. MwSt.)																																																																																	
1.106	Filtereinsatz , Sinterkunststoffsieb 50µ, gelb, mit Bajonettverschluss für Nr 493 370	493 380																																																																																		
1.107	Filtereinsatz , Edelstahlsieb 100µ, mit Bajonettverschluss für Nr. 493 383, 493 386, 493 388, 493 389, 493 397, 493 403	493 391																																																																																		
1.108	Ersatzteile für V- und Z-Ölfilter O-Ring	493 384																																																																																		
1.109	Filtertasse , Kunststoff (Saugbetrieb)	493 379																																																																																		
1.110	Filtertasse , Messing (Druck- u. Saugbetrieb)	493 378																																																																																		
1.111	Spaltfilter , für Heizöl EL, M und S Typ F95E bis F200E ist mit Filterheizung 115V bzw. 230V ausgestattet für Zulaufbetrieb bis max. 6 bar geeignet																																																																																			
	<table border="1"> <thead> <tr> <th>Typ</th> <th>Anschlüsse Eingang</th> <th>Ausgang</th> <th>Spalt- weite mm</th> <th>Durchflussmenge EL l/h</th> <th>M l/h</th> <th>S l/h</th> <th>Beheizung Leistung W</th> <th>Spannung V</th> </tr> </thead> <tbody> <tr> <td>F95</td> <td>1</td> <td>1</td> <td>0,1</td> <td>1200</td> <td></td> <td></td> <td></td> <td>109 000 0026 2</td> </tr> <tr> <td>F150</td> <td>1</td> <td>1</td> <td>0,1</td> <td>2000</td> <td></td> <td></td> <td></td> <td>109 000 0027 2</td> </tr> <tr> <td>F95E</td> <td>1</td> <td>1</td> <td>0,1</td> <td></td> <td></td> <td>500</td> <td>55</td> <td>230</td> </tr> <tr> <td>F150E</td> <td>1</td> <td>1</td> <td>0,1</td> <td></td> <td></td> <td>850</td> <td>55</td> <td>230</td> </tr> <tr> <td>F200E</td> <td>1 1/4</td> <td>1</td> <td>0,2</td> <td></td> <td></td> <td>1200</td> <td>66</td> <td>230</td> </tr> <tr> <td>F95E</td> <td>1</td> <td>1</td> <td>0,1</td> <td></td> <td></td> <td>500</td> <td>55</td> <td>115</td> </tr> <tr> <td>F150E</td> <td>1</td> <td>1</td> <td>0,1</td> <td></td> <td></td> <td>850</td> <td>55</td> <td>115</td> </tr> <tr> <td>F200E</td> <td>1 1/4</td> <td>1</td> <td>0,2</td> <td></td> <td></td> <td>1200</td> <td>66</td> <td>115</td> </tr> </tbody> </table>	Typ	Anschlüsse Eingang	Ausgang	Spalt- weite mm	Durchflussmenge EL l/h	M l/h	S l/h	Beheizung Leistung W	Spannung V	F95	1	1	0,1	1200				109 000 0026 2	F150	1	1	0,1	2000				109 000 0027 2	F95E	1	1	0,1			500	55	230	F150E	1	1	0,1			850	55	230	F200E	1 1/4	1	0,2			1200	66	230	F95E	1	1	0,1			500	55	115	F150E	1	1	0,1			850	55	115	F200E	1 1/4	1	0,2			1200	66	115		
Typ	Anschlüsse Eingang	Ausgang	Spalt- weite mm	Durchflussmenge EL l/h	M l/h	S l/h	Beheizung Leistung W	Spannung V																																																																												
F95	1	1	0,1	1200				109 000 0026 2																																																																												
F150	1	1	0,1	2000				109 000 0027 2																																																																												
F95E	1	1	0,1			500	55	230																																																																												
F150E	1	1	0,1			850	55	230																																																																												
F200E	1 1/4	1	0,2			1200	66	230																																																																												
F95E	1	1	0,1			500	55	115																																																																												
F150E	1	1	0,1			850	55	115																																																																												
F200E	1 1/4	1	0,2			1200	66	115																																																																												
	Anschlussteile bei Bedarf: Einschraubstutzen G1 a x M30 x 1,5 a für Schlauchanschluss DN20 Einschraubstutzen G1 a x M38 x 1,5 a für Schlauchanschluss DN25 Reduzierstutzen G1 a x G1/2 i Dichtring A33 x 39 x 2 für G1		112 151 0005 7 122 362 0007 7 453 752 440 032																																																																																	
1.112	Spaltfilter mit Motorantrieb 230 V, 50-60 Hz F95E F150E F200E		109 000 0334 2 109 000 0335 2 109 000 0336 2																																																																																	
1.113	Stellantrieb STM30 230V, 50-60 Hz		651 041																																																																																	
1.114	Filter (Einfach-Siebfilter) für Heizöl EL, S Gehäuse aus GGG 40, Plandichtung, Schweißflansche nach DIN2635, Stern-Siebelement, Filterfeinheit 0,32 mm Betriebsdruck max. 30 bar, einschließlich Gegenflanschen																																																																																			
	<table border="1"> <thead> <tr> <th>Typ</th> <th>DN</th> <th>PN</th> <th>Brutto- Siebfläche cm²</th> <th>Durchflussmenge l/h* HEL MS</th> </tr> </thead> <tbody> <tr> <td>1.12.2</td> <td>25</td> <td>40</td> <td>652</td> <td>5000 3000</td> </tr> <tr> <td>1.12.2</td> <td>32</td> <td>40</td> <td>1000</td> <td>8000 5000</td> </tr> <tr> <td>1.12.2</td> <td>40</td> <td>40</td> <td>1900</td> <td>13000 9000</td> </tr> <tr> <td>1.12.2</td> <td>50</td> <td>40</td> <td>2460</td> <td>20000 13000</td> </tr> <tr> <td>1.03.2</td> <td>65</td> <td>10</td> <td>4400</td> <td>35000 25000</td> </tr> </tbody> </table>	Typ	DN	PN	Brutto- Siebfläche cm²	Durchflussmenge l/h* HEL MS	1.12.2	25	40	652	5000 3000	1.12.2	32	40	1000	8000 5000	1.12.2	40	40	1900	13000 9000	1.12.2	50	40	2460	20000 13000	1.03.2	65	10	4400	35000 25000		493 514 493 515 493 516 493 517 493 496 **																																																			
Typ	DN	PN	Brutto- Siebfläche cm²	Durchflussmenge l/h* HEL MS																																																																																
1.12.2	25	40	652	5000 3000																																																																																
1.12.2	32	40	1000	8000 5000																																																																																
1.12.2	40	40	1900	13000 9000																																																																																
1.12.2	50	40	2460	20000 13000																																																																																
1.03.2	65	10	4400	35000 25000																																																																																
	Einfachfilter mit Sternsiebfilter , Maschenweite 0,1 mm und Magneteinsatz (Verwendung nur bei Multiflambrenner)																																																																																			
	<table border="1"> <thead> <tr> <th>Typ</th> <th>DN</th> <th>PN</th> <th>Brutto- Siebfläche cm²</th> <th>Durchflussmenge l/h* HEL MS</th> </tr> </thead> <tbody> <tr> <td>1.12.2</td> <td>G1</td> <td>40</td> <td>652</td> <td>5000 (nicht verwendbar bei separater Pumpstation)</td> </tr> <tr> <td>1.12.2</td> <td>25</td> <td>40</td> <td>652</td> <td>5000 (Bei Einsatz auf der Hochdruckseite z.B. WK-Brenner mit separater Pumpstation)</td> </tr> </tbody> </table>	Typ	DN	PN	Brutto- Siebfläche cm²	Durchflussmenge l/h* HEL MS	1.12.2	G1	40	652	5000 (nicht verwendbar bei separater Pumpstation)	1.12.2	25	40	652	5000 (Bei Einsatz auf der Hochdruckseite z.B. WK-Brenner mit separater Pumpstation)		493 518 493 519																																																																		
Typ	DN	PN	Brutto- Siebfläche cm²	Durchflussmenge l/h* HEL MS																																																																																
1.12.2	G1	40	652	5000 (nicht verwendbar bei separater Pumpstation)																																																																																
1.12.2	25	40	652	5000 (Bei Einsatz auf der Hochdruckseite z.B. WK-Brenner mit separater Pumpstation)																																																																																
1.115	Filter (Doppelfilter) für Heizöl EL und S, Gehäuse und Hahnkükten aus GGG 40, Plandichtung, Flansche als Vierkantflansche gebohrt, Sternsieb aus Edelstahl Maschenweite 0,32 mm, Betriebsdruck max. 25 bar, einschließlich Gegenflanschen																																																																																			
	<table border="1"> <thead> <tr> <th>Typ</th> <th>DN</th> <th>Brutto- Siebfläche cm²</th> <th>Durchflussmenge l/h* HEL MS</th> </tr> </thead> <tbody> <tr> <td>2.04.5</td> <td>25</td> <td>652</td> <td>3000 2000</td> </tr> <tr> <td></td> <td>32</td> <td>1000</td> <td>5000 3000</td> </tr> <tr> <td></td> <td>40</td> <td>1900</td> <td>8000 5000</td> </tr> <tr> <td></td> <td>50</td> <td>2460</td> <td>12000 8000</td> </tr> <tr> <td></td> <td>65</td> <td>3885</td> <td>20000 12000</td> </tr> </tbody> </table>	Typ	DN	Brutto- Siebfläche cm²	Durchflussmenge l/h* HEL MS	2.04.5	25	652	3000 2000		32	1000	5000 3000		40	1900	8000 5000		50	2460	12000 8000		65	3885	20000 12000		493 497 493 498 493 499 493 500 493 501 **																																																									
Typ	DN	Brutto- Siebfläche cm²	Durchflussmenge l/h* HEL MS																																																																																	
2.04.5	25	652	3000 2000																																																																																	
	32	1000	5000 3000																																																																																	
	40	1900	8000 5000																																																																																	
	50	2460	12000 8000																																																																																	
	65	3885	20000 12000																																																																																	

* Die angegebenen Durchflussmengen gelten beim Einbau in die Druckleitung, beim Einbau in die Saugleitung ist nur die Hälfte dieser Werte zulässig. Bei der Festlegung wurde ein Heizöl mit einer Viskosität von 380 cSt bei 50°C zugrunde gelegt.

** Liefertermin auf Anfrage

No.	Description																																																																																										
1.106	Filter insert , sinter plastic strainer 50 µ yellow with bayonet connection for No. 493 370																																																																																										
1.107	Filter insert , stainless steel strainer 100 µ, with bayonet connection for Nos. 493 383, 493 386, 493 388, 493 389, 493 397, 493 403																																																																																										
1.108	Spare parts for V and Z oil filter O ring																																																																																										
1.109	Filter cup , plastic (suction operation)																																																																																										
1.110	Filter cup , brass (pressure + suction operation)																																																																																										
1.111	Edge plate filter , for fuel oil EL, M and S type F95E to F200E is equipped with filter heating 115V or 230V suitable for pressure operation up to max. 6 bar																																																																																										
	<table border="1"> <thead> <tr> <th>Type</th> <th>Connection inlet</th> <th>Connection outlet</th> <th>Aperture</th> <th>Capacity EL</th> <th>M</th> <th>S</th> <th>Heating rating</th> <th>voltage</th> </tr> <tr> <td></td> <td>G</td> <td>G</td> <td>mm</td> <td>l/h</td> <td>l/h</td> <td>l/h</td> <td>W</td> <td>V</td> </tr> </thead> <tbody> <tr> <td>F95</td> <td>1</td> <td>1</td> <td>0,1</td> <td>1200</td> <td></td> <td></td> <td></td> <td></td> </tr> <tr> <td>F150</td> <td>1</td> <td>1</td> <td>0,1</td> <td>2000</td> <td></td> <td></td> <td></td> <td></td> </tr> <tr> <td>F95E</td> <td>1</td> <td>1</td> <td>0,1</td> <td></td> <td></td> <td>500</td> <td>55</td> <td>230</td> </tr> <tr> <td>F150E</td> <td>1</td> <td>1</td> <td>0,1</td> <td></td> <td></td> <td>850</td> <td>55</td> <td>230</td> </tr> <tr> <td>F200E</td> <td>1 1/4</td> <td>1</td> <td>0,2</td> <td></td> <td></td> <td>1200</td> <td>66</td> <td>230</td> </tr> <tr> <td>F95E</td> <td>1</td> <td>1</td> <td>0,1</td> <td></td> <td></td> <td>500</td> <td>55</td> <td>115</td> </tr> <tr> <td>F150E</td> <td>1</td> <td>1</td> <td>0,1</td> <td></td> <td></td> <td>850</td> <td>55</td> <td>11</td> </tr> <tr> <td>F200E</td> <td>1 1/4</td> <td>1</td> <td>0,2</td> <td></td> <td></td> <td>1200</td> <td>66</td> <td>115</td> </tr> </tbody> </table>	Type	Connection inlet	Connection outlet	Aperture	Capacity EL	M	S	Heating rating	voltage		G	G	mm	l/h	l/h	l/h	W	V	F95	1	1	0,1	1200					F150	1	1	0,1	2000					F95E	1	1	0,1			500	55	230	F150E	1	1	0,1			850	55	230	F200E	1 1/4	1	0,2			1200	66	230	F95E	1	1	0,1			500	55	115	F150E	1	1	0,1			850	55	11	F200E	1 1/4	1	0,2			1200	66	115
Type	Connection inlet	Connection outlet	Aperture	Capacity EL	M	S	Heating rating	voltage																																																																																			
	G	G	mm	l/h	l/h	l/h	W	V																																																																																			
F95	1	1	0,1	1200																																																																																							
F150	1	1	0,1	2000																																																																																							
F95E	1	1	0,1			500	55	230																																																																																			
F150E	1	1	0,1			850	55	230																																																																																			
F200E	1 1/4	1	0,2			1200	66	230																																																																																			
F95E	1	1	0,1			500	55	115																																																																																			
F150E	1	1	0,1			850	55	11																																																																																			
F200E	1 1/4	1	0,2			1200	66	115																																																																																			
	<p>Connection parts available: Threaded socket G1 m x M30 x 1.5 m for hose connection DN20 Threaded socket G1 m x M38 x 1.5 m for hose connection DN25 Reducing nipple G1 m x G1/2 f Sealing ring A33 x 39 x 2 for G1</p>																																																																																										
1.112	Edge plate filter motor driven 230V, 50 - 60 Hz F95 F150E F200E																																																																																										
1.113	Servomotor STM30 230V, 50-60 Hz																																																																																										
1.114	Filter (single mesh filter) for fuel oil EL, S Housing made of GGG40, flat seal, flange to DIN2635, Strainer, aperture 0.32 mm, operating pressure max. 30 bar, including counter flanges																																																																																										
	<table border="1"> <thead> <tr> <th>Type</th> <th>DN</th> <th>PN</th> <th>Gross strainer area cm²</th> <th>Capacity l/h* Oil L</th> <th>Oil S</th> </tr> </thead> <tbody> <tr> <td>1.12.2</td> <td>25</td> <td>40</td> <td>652</td> <td>5000</td> <td>3000</td> </tr> <tr> <td>1.12.2</td> <td>32</td> <td>40</td> <td>1000</td> <td>8000</td> <td>5000</td> </tr> <tr> <td>1.12.2</td> <td>40</td> <td>40</td> <td>1900</td> <td>13000</td> <td>9000</td> </tr> <tr> <td>1.12.2</td> <td>50</td> <td>40</td> <td>2460</td> <td>20000</td> <td>13000</td> </tr> <tr> <td>1.03.2</td> <td>65</td> <td>10</td> <td>4400</td> <td>35000</td> <td>25000</td> </tr> </tbody> </table>	Type	DN	PN	Gross strainer area cm ²	Capacity l/h* Oil L	Oil S	1.12.2	25	40	652	5000	3000	1.12.2	32	40	1000	8000	5000	1.12.2	40	40	1900	13000	9000	1.12.2	50	40	2460	20000	13000	1.03.2	65	10	4400	35000	25000																																																						
Type	DN	PN	Gross strainer area cm ²	Capacity l/h* Oil L	Oil S																																																																																						
1.12.2	25	40	652	5000	3000																																																																																						
1.12.2	32	40	1000	8000	5000																																																																																						
1.12.2	40	40	1900	13000	9000																																																																																						
1.12.2	50	40	2460	20000	13000																																																																																						
1.03.2	65	10	4400	35000	25000																																																																																						
	<p>Single filter with strainer, aperture 0.1 mm and magnetic filter (used only on multiflam burners)</p> <table border="1"> <thead> <tr> <th>Type</th> <th>DN</th> <th>PN</th> <th>Gross strainer area cm²</th> <th>Capacity l/h* Oil L</th> </tr> </thead> <tbody> <tr> <td>1.12.2</td> <td>G1</td> <td>40</td> <td>652</td> <td>5000</td> </tr> <tr> <td>1.14.2</td> <td>25</td> <td>40</td> <td>652</td> <td>5000</td> </tr> </tbody> </table>	Type	DN	PN	Gross strainer area cm ²	Capacity l/h* Oil L	1.12.2	G1	40	652	5000	1.14.2	25	40	652	5000																																																																											
Type	DN	PN	Gross strainer area cm ²	Capacity l/h* Oil L																																																																																							
1.12.2	G1	40	652	5000																																																																																							
1.14.2	25	40	652	5000																																																																																							
1.115	Filter (double filter) for fuel oil EL and S, housing and c/o valve made of GGG40, flat seal, flange drilled off centres, stainless steel filter aperture 0.32mm, operating pressure max. 25 bar, including counter flanges																																																																																										
	<table border="1"> <thead> <tr> <th>Type</th> <th>DN</th> <th>Gross strainer area cm²</th> <th>Capacity l/h* Oil L</th> <th>Oil S</th> </tr> </thead> <tbody> <tr> <td>2.04.5</td> <td>25</td> <td>652</td> <td>3000</td> <td>2000</td> </tr> <tr> <td></td> <td>32</td> <td>1000</td> <td>5000</td> <td>3000</td> </tr> <tr> <td></td> <td>40</td> <td>1900</td> <td>8000</td> <td>5000</td> </tr> <tr> <td></td> <td>50</td> <td>2460</td> <td>12000</td> <td>8000</td> </tr> <tr> <td></td> <td>65</td> <td>3885</td> <td>20000</td> <td>12000</td> </tr> </tbody> </table>	Type	DN	Gross strainer area cm ²	Capacity l/h* Oil L	Oil S	2.04.5	25	652	3000	2000		32	1000	5000	3000		40	1900	8000	5000		50	2460	12000	8000		65	3885	20000	12000																																																												
Type	DN	Gross strainer area cm ²	Capacity l/h* Oil L	Oil S																																																																																							
2.04.5	25	652	3000	2000																																																																																							
	32	1000	5000	3000																																																																																							
	40	1900	8000	5000																																																																																							
	50	2460	12000	8000																																																																																							
	65	3885	20000	12000																																																																																							
	<p>* The capacities quoted are valid for installation in the pressure line, if installing in the suction line, only half of these values are relevant. These values are based on a fuel oil with a viscosity of 380 cSt at 50 °C. ** Delivery time on request</p>																																																																																										

No.	Dénomination																																																																																										
1.106	Cartouche filtrante , filtre fritté 50µ, jaune, avec fermeture à baïonnette pour Nr 493 370																																																																																										
1.107	Cartouche filtrante , filtre inox 100µ, avec fermeture à baïonnette pour Nr. 493 383, 493 386, 493 388, 493 389, 493 397, 493 403																																																																																										
1.108	Pièces détachées pour filtres V (mono-tube) et Z (bi-tubes) Joint torique																																																																																										
1.109	Pot , plastique (fonctionnement en aspiration)																																																																																										
1.110	Pot , laiton (fonctionnement en pression ou en aspiration)																																																																																										
1.111	Filtre , pour FOD et FOL Type F95E à F200E est équipé d'un réchauffage de 115V resp. 230V adapté pour un fonctionnement en aspiration jusqu'à max. 6 bar																																																																																										
	<table border="1"> <thead> <tr> <th>Type</th> <th>Raccordements Entrée</th> <th>Sortie</th> <th>Ecartem. mailles</th> <th>Débit FOD</th> <th>Léger</th> <th>FOL</th> <th>Réchauffage Puis.</th> <th>Tension</th> </tr> <tr> <td></td> <td>G</td> <td>G</td> <td>mm</td> <td>l/h</td> <td>l/h</td> <td>l/h</td> <td>W</td> <td>V</td> </tr> </thead> <tbody> <tr> <td>F95</td> <td>1</td> <td>1</td> <td>0,1</td> <td>1200</td> <td></td> <td></td> <td></td> <td></td> </tr> <tr> <td>F150</td> <td>1</td> <td>1</td> <td>0,1</td> <td>2000</td> <td></td> <td></td> <td></td> <td></td> </tr> <tr> <td>F95E</td> <td>1</td> <td>1</td> <td>0,1</td> <td></td> <td></td> <td>500</td> <td>55</td> <td>230</td> </tr> <tr> <td>F150E</td> <td>1</td> <td>1</td> <td>0,1</td> <td></td> <td></td> <td>850</td> <td>55</td> <td>230</td> </tr> <tr> <td>F200E</td> <td>1 1/4</td> <td>1</td> <td>0,2</td> <td></td> <td></td> <td>1200</td> <td>66</td> <td>230</td> </tr> <tr> <td>F95E</td> <td>1</td> <td>1</td> <td>0,1</td> <td></td> <td></td> <td>500</td> <td>55</td> <td>115</td> </tr> <tr> <td>F150E</td> <td>1</td> <td>1</td> <td>0,1</td> <td></td> <td></td> <td>850</td> <td>55</td> <td>11</td> </tr> <tr> <td>F200E</td> <td>1 1/4</td> <td>1</td> <td>0,2</td> <td></td> <td></td> <td>1200</td> <td>66</td> <td>115</td> </tr> </tbody> </table>	Type	Raccordements Entrée	Sortie	Ecartem. mailles	Débit FOD	Léger	FOL	Réchauffage Puis.	Tension		G	G	mm	l/h	l/h	l/h	W	V	F95	1	1	0,1	1200					F150	1	1	0,1	2000					F95E	1	1	0,1			500	55	230	F150E	1	1	0,1			850	55	230	F200E	1 1/4	1	0,2			1200	66	230	F95E	1	1	0,1			500	55	115	F150E	1	1	0,1			850	55	11	F200E	1 1/4	1	0,2			1200	66	115
Type	Raccordements Entrée	Sortie	Ecartem. mailles	Débit FOD	Léger	FOL	Réchauffage Puis.	Tension																																																																																			
	G	G	mm	l/h	l/h	l/h	W	V																																																																																			
F95	1	1	0,1	1200																																																																																							
F150	1	1	0,1	2000																																																																																							
F95E	1	1	0,1			500	55	230																																																																																			
F150E	1	1	0,1			850	55	230																																																																																			
F200E	1 1/4	1	0,2			1200	66	230																																																																																			
F95E	1	1	0,1			500	55	115																																																																																			
F150E	1	1	0,1			850	55	11																																																																																			
F200E	1 1/4	1	0,2			1200	66	115																																																																																			
	<p>Pièces détachées en cas de besoin : Mamelon G1 a x M30 x 1,5 a pour raccordement flexibles DN20 Mamelon G1 a x M38 x 1,5 a pour raccordement flexibles DN25 Réduction G1 a x G1/2 i Joint A33 x 39 x 2 pour G1</p>																																																																																										
1.112	Filtre à peigne avec entraînement moteur 230 V, 50-60 Hz F95 F150E F200E																																																																																										
1.113	Servomoteur STM30 230V, 50-60 Hz																																																																																										
1.114	Filtre (filtre simple) pour FOD, FOL Corps en GGG 40, joint plat, brides selon DIN2635, Elément filtrant, écartement mailles 0,32 mm Pression de service max. 30 bar, y compris contre-brides																																																																																										
	<table border="1"> <thead> <tr> <th>Type</th> <th>DN</th> <th>PN</th> <th>Surface filtrante brute en cm²</th> <th>Débit l/h* FOD</th> <th>FOL</th> </tr> </thead> <tbody> <tr> <td>1.12.2</td> <td>25</td> <td>40</td> <td>652</td> <td>5000</td> <td>3000</td> </tr> <tr> <td>1.12.2</td> <td>32</td> <td>40</td> <td>1000</td> <td>8000</td> <td>5000</td> </tr> <tr> <td>1.12.2</td> <td>40</td> <td>40</td> <td>1900</td> <td>13000</td> <td>9000</td> </tr> <tr> <td>1.12.2</td> <td>50</td> <td>40</td> <td>2460</td> <td>20000</td> <td>13000</td> </tr> <tr> <td>1.03.2</td> <td>65</td> <td>10</td> <td>4400</td> <td>35000</td> <td>25000</td> </tr> </tbody> </table>	Type	DN	PN	Surface filtrante brute en cm ²	Débit l/h* FOD	FOL	1.12.2	25	40	652	5000	3000	1.12.2	32	40	1000	8000	5000	1.12.2	40	40	1900	13000	9000	1.12.2	50	40	2460	20000	13000	1.03.2	65	10	4400	35000	25000																																																						
Type	DN	PN	Surface filtrante brute en cm ²	Débit l/h* FOD	FOL																																																																																						
1.12.2	25	40	652	5000	3000																																																																																						
1.12.2	32	40	1000	8000	5000																																																																																						
1.12.2	40	40	1900	13000	9000																																																																																						
1.12.2	50	40	2460	20000	13000																																																																																						
1.03.2	65	10	4400	35000	25000																																																																																						
	<p>Filtre simple avec cartouche étoile, mailles 0,1 mm et aimant (utilisation uniquement avec brûleurs multiflam)</p> <table border="1"> <thead> <tr> <th>Type</th> <th>DN</th> <th>PN</th> <th>Surface filtrante brute en cm²</th> <th>Débit l/h* FOD</th> </tr> </thead> <tbody> <tr> <td>1.12.2</td> <td>G1</td> <td>40</td> <td>652</td> <td>5000</td> </tr> <tr> <td>1.14.2</td> <td>25</td> <td>40</td> <td>652</td> <td>5000</td> </tr> </tbody> </table>	Type	DN	PN	Surface filtrante brute en cm ²	Débit l/h* FOD	1.12.2	G1	40	652	5000	1.14.2	25	40	652	5000																																																																											
Type	DN	PN	Surface filtrante brute en cm ²	Débit l/h* FOD																																																																																							
1.12.2	G1	40	652	5000																																																																																							
1.14.2	25	40	652	5000																																																																																							
1.115	Filtre (filtre double) pour FOD et FOL, Corps et robinet avec poignée en GGG 40, joint plat, bride carrée percée filtre en inox écartement mailles 0,32 mm, Pression de service max. 25 bar, y compris contre-brides																																																																																										
	<table border="1"> <thead> <tr> <th>Type</th> <th>DN</th> <th>Surface filtrante brute en cm²</th> <th>Débit l/h* FOD</th> <th>FOL</th> </tr> </thead> <tbody> <tr> <td>2.04.5</td> <td>25</td> <td>652</td> <td>3000</td> <td>2000</td> </tr> <tr> <td></td> <td>32</td> <td>1000</td> <td>5000</td> <td>3000</td> </tr> <tr> <td></td> <td>40</td> <td>1900</td> <td>8000</td> <td>5000</td> </tr> <tr> <td></td> <td>50</td> <td>2460</td> <td>12000</td> <td>8000</td> </tr> <tr> <td></td> <td>65</td> <td>3885</td> <td>20000</td> <td>12000</td> </tr> </tbody> </table>	Type	DN	Surface filtrante brute en cm ²	Débit l/h* FOD	FOL	2.04.5	25	652	3000	2000		32	1000	5000	3000		40	1900	8000	5000		50	2460	12000	8000		65	3885	20000	12000																																																												
Type	DN	Surface filtrante brute en cm ²	Débit l/h* FOD	FOL																																																																																							
2.04.5	25	652	3000	2000																																																																																							
	32	1000	5000	3000																																																																																							
	40	1900	8000	5000																																																																																							
	50	2460	12000	8000																																																																																							
	65	3885	20000	12000																																																																																							
	<p>* Les débits indiqués sont valables pour le montage dans la conduite HP, lors du montage sur l'aspiration on ne peut admettre que la moitié de ces valeurs. Lors de la détermination il a été choisi un fioul avec une viscosité de 380 cSt à 50 °C . ** Délai de livraison sur demande</p>																																																																																										

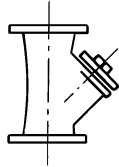
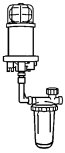

1.116

1.124

Nr.	Bezeichnung	Bestell-Nr. Order No. N° de commande	Preis EUR (o. MwSt.)																										
Doppelfilter mit Sternsiebfilter, Maschenweite 0,1 mm und Magneteinsatz (Verwendung nur bei Multiflambrenner)																													
	<table border="1"> <thead> <tr> <th>Typ</th> <th>DN</th> <th>PN</th> <th>Brutto-Siebläche cm²</th> <th>Durchflussmenge l/h* L-Öl</th> </tr> </thead> <tbody> <tr> <td>2.04.5</td> <td>25</td> <td>40</td> <td>2 x 652</td> <td>3000</td> </tr> </tbody> </table>	Typ	DN	PN	Brutto-Siebläche cm ²	Durchflussmenge l/h* L-Öl	2.04.5	25	40	2 x 652	3000	493 511																	
Typ	DN	PN	Brutto-Siebläche cm ²	Durchflussmenge l/h* L-Öl																									
2.04.5	25	40	2 x 652	3000																									
* Die angegebenen Durchflussmengen gelten beim Einbau in die Druckleitung, beim Einbau in die Saugleitung ist nur die Hälfte dieser Werte zulässig. Bei der Festlegung wurde ein Heizöl mit einer Viskosität von 380 cSt bei 50°C zugrunde gelegt.																													
1.116	Entlüfter FloCo-TOP/K mit Filter V 500 Si , für Einstrangbetrieb mit Halter, Sinterkunststoffsieb 50µ Anschlüsse: tankseitig: 1 x G3/8 i brennerseitig: 2 x G3/8 a für Schlauchanschluss Düsenleistung: max. 100 l/h Rücklaufstrom: max. 120 l/h Betriebstemperatur: max. 60° C Betriebsüberdruck: max. 0,7 bar	662 031																											
1.117	Filtereinsatz Sinterkunststoffsieb 50µ, gelb, mit Bajonettverschluss für Nr. 662 031	493 380																											
Ersatzteile für Ölfilter (ohne Bild)																													
1.119	Spaltfiltereinsatz für Filtertyp F 95, F 95 E, F150, F150 E F200 E	493 109 493 111 493 112																											
1.120	Dichtung für alle F-Filter	112 151 1903 7																											
1.121	Heizkörper (Sonderspannungen auf Anfrage) für Filter F95 E, F 150 E, 230V, 55W F 200 E, 230V, 66W	109 000 0618 2 109 000 0620 2																											
1.122	Dichtring Viton für Filter Typ 2.04.5 50 x 67 x 1,5, DN 25/DN 32 62 x 84 x 1,5, DN 40 78 x 94 x 1,5, DN 50 90 x 110 x 1,5, DN 65	441 064 441 065 441 066 441 067																											
1.123	O-Ring 69,4 x 3,53 für Filterdeckel DN 25/32 88,49 x 3,53 für Filterdeckel DN 40/50	445 114 445 115																											
Schmutzfänger																													
1.124	Schmutzfänger , DN25, PN40, Flanschausführung aus Gussstahl und Edelstahlsieb	499 044																											
1.2 Öl-Absperrorgane																													
1.202	Kugelhahn PN40 , für Heizöl "EL" Gehäuse und Kugel: Messing verchromt, Dichtungen aus Teflon und Viton, mit Innengewinde nach DIN ISO 228/1																												
	<table border="1"> <thead> <tr> <th>Typ</th> <th>DN</th> <th></th> </tr> </thead> <tbody> <tr> <td>984-D</td> <td>Rp 1/4</td> <td>454 657</td> </tr> <tr> <td>984-D</td> <td>Rp 3/8</td> <td>454 658</td> </tr> <tr> <td>984-D</td> <td>Rp 1/2</td> <td>454 659</td> </tr> <tr> <td>984-D</td> <td>Rp 3/4</td> <td>454 660</td> </tr> <tr> <td>984-D</td> <td>Rp 1 nach DIN 4755, Teil nur bis DN25 (G 1) zulässig</td> <td>454 661</td> </tr> <tr> <td>984-D</td> <td>Rp 1 1/4</td> <td>454 662</td> </tr> <tr> <td>984-D</td> <td>Rp 1 1/2</td> <td>454 663</td> </tr> <tr> <td>984-D</td> <td>Rp 2</td> <td>454 664</td> </tr> </tbody> </table>	Typ	DN		984-D	Rp 1/4	454 657	984-D	Rp 3/8	454 658	984-D	Rp 1/2	454 659	984-D	Rp 3/4	454 660	984-D	Rp 1 nach DIN 4755, Teil nur bis DN25 (G 1) zulässig	454 661	984-D	Rp 1 1/4	454 662	984-D	Rp 1 1/2	454 663	984-D	Rp 2	454 664	
Typ	DN																												
984-D	Rp 1/4	454 657																											
984-D	Rp 3/8	454 658																											
984-D	Rp 1/2	454 659																											
984-D	Rp 3/4	454 660																											
984-D	Rp 1 nach DIN 4755, Teil nur bis DN25 (G 1) zulässig	454 661																											
984-D	Rp 1 1/4	454 662																											
984-D	Rp 1 1/2	454 663																											
984-D	Rp 2	454 664																											
1.203	Kugelhahn für Heizöl "M und S" Gehäuse: Stahl; ab G 1 1/4"; GGG 40; Kugel: Stahl hartverchromt; Dichtungen aus Teflon, mit Innengewinde nach DIN ISO 228/1																												
	<table border="1"> <thead> <tr> <th>PN</th> <th>G</th> <th></th> </tr> </thead> <tbody> <tr> <td>PN 100</td> <td>G 1/4</td> <td>454 047</td> </tr> <tr> <td>PN 100</td> <td>G 3/8</td> <td>454 159</td> </tr> <tr> <td>PN 250</td> <td>G 1/2</td> <td>454 181</td> </tr> <tr> <td>PN 175</td> <td>G 3/4</td> <td>454 182</td> </tr> <tr> <td>PN 63</td> <td>G 1 nach DIN 4755, Teil 2 nur bis DN25 (R1") zulässig</td> <td>454 162</td> </tr> </tbody> </table>	PN	G		PN 100	G 1/4	454 047	PN 100	G 3/8	454 159	PN 250	G 1/2	454 181	PN 175	G 3/4	454 182	PN 63	G 1 nach DIN 4755, Teil 2 nur bis DN25 (R1") zulässig	454 162										
PN	G																												
PN 100	G 1/4	454 047																											
PN 100	G 3/8	454 159																											
PN 250	G 1/2	454 181																											
PN 175	G 3/4	454 182																											
PN 63	G 1 nach DIN 4755, Teil 2 nur bis DN25 (R1") zulässig	454 162																											

No.	Description																		
	<p>Double filter with strainer, aperture 0.1 mm and magnetic insert (used only on multiflam burners)</p> <table border="1"> <thead> <tr> <th>Type</th> <th>DN</th> <th>PN</th> <th>Gross strainer area cm²</th> <th>Capacity l/h* Oil L</th> </tr> </thead> <tbody> <tr> <td>2.04.5</td> <td>25</td> <td>40</td> <td>2 x 652</td> <td>3000</td> </tr> </tbody> </table> <p>* The capacities quoted are valid for installation in the pressure line, if installing in the suction line, only half of these values are relevant. These values are based on a fuel oil with a viscosity of 380 cSt at 50 °C.</p>	Type	DN	PN	Gross strainer area cm ²	Capacity l/h* Oil L	2.04.5	25	40	2 x 652	3000								
Type	DN	PN	Gross strainer area cm ²	Capacity l/h* Oil L															
2.04.5	25	40	2 x 652	3000															
1.116	<p>De-aerator FloCo-top/K with filter V 500 Si, for single pipe operation with bracket, sinter plastic strainer 50µ</p> <p>Connection: tank side: 1 x G3/8f burner side: 2 x G3/8 m for hose connection</p> <p>Nozzle capacity: max. 100 l/h Return flow: max. 120 l/h Operating temperature: max. 60 °C Operating pressure: max. 0.7 bar</p>																		
1.117	<p>Filter insert sinter plastic strainer 50µ, yellow, with bayonet connection for No. 662 031</p>																		
	<p>Spare parts for oil filter (without picture)</p>																		
1.119	<p>Edge plate filter insert for filter type F95, F95E, F50, F150E, F200E</p>																		
1.120	<p>Sealing for all F-filter</p>																		
1.121	<p>Heating element (special voltages on request) for filter F95 E, F 150 E, 230V, 55W F 200 E, 230V, 66W</p>																		
1.122	<p>Sealing ring Viton for filter type 2.04.5 50 x 67 x 1.5, DN 25/DN 32 62 x 84 x 1.5, DN 40 78 x 94 x 1.5, DN 50 90 x 110 x 1.5, DN 65</p>																		
1.123	<p>O ring 69.4 x 3.53 for filter cover DN25/32 88.49 x 3.53 for filter cover DN40/50</p>																		
	<p>Strainer</p>																		
1.124	<p>Strainer, DN25, PN40, flanged version cast steel and stain. steel strainer</p>																		
	<p>1.2 Oil shut off devices</p>																		
1.202	<p>Ball valve PN40, for fuel oil "EL" Casing and Ball: Brass, chromium-plated, Teflon seal, with internal thread to DIN ISO 228/1</p> <table border="1"> <thead> <tr> <th>Type</th> <th>DN</th> </tr> </thead> <tbody> <tr> <td>984-D</td> <td>Rp 1/4</td> </tr> <tr> <td>984-D</td> <td>Rp 3/8</td> </tr> <tr> <td>984-D</td> <td>Rp 1/2</td> </tr> <tr> <td>984-D</td> <td>Rp 3/4</td> </tr> <tr> <td>984-D</td> <td>Rp 1 to DIN 4755, Part 2 approved only to DN25 (G1)</td> </tr> <tr> <td>984-D</td> <td>Rp 1 1/4</td> </tr> <tr> <td>984-D</td> <td>Rp 1 1/2</td> </tr> <tr> <td>984-D</td> <td>Rp 2</td> </tr> </tbody> </table>	Type	DN	984-D	Rp 1/4	984-D	Rp 3/8	984-D	Rp 1/2	984-D	Rp 3/4	984-D	Rp 1 to DIN 4755, Part 2 approved only to DN25 (G1)	984-D	Rp 1 1/4	984-D	Rp 1 1/2	984-D	Rp 2
Type	DN																		
984-D	Rp 1/4																		
984-D	Rp 3/8																		
984-D	Rp 1/2																		
984-D	Rp 3/4																		
984-D	Rp 1 to DIN 4755, Part 2 approved only to DN25 (G1)																		
984-D	Rp 1 1/4																		
984-D	Rp 1 1/2																		
984-D	Rp 2																		
1.203	<p>Ball valve, for fuel oil "M and S" Casing: Steel; from G1 1/4"; GGG40; Ball: steel chromium plated; Teflon seal, with internal thread to DIN ISO 228/1</p> <table border="1"> <thead> <tr> <th>PN</th> <th>G</th> </tr> </thead> <tbody> <tr> <td>PN 100</td> <td>G 1/4</td> </tr> <tr> <td>PN 100</td> <td>G 3/8</td> </tr> <tr> <td>PN 250</td> <td>G 1/2</td> </tr> <tr> <td>PN 175</td> <td>G 3/4</td> </tr> <tr> <td>PN 63</td> <td>G 1 to DIN 4755, Part 2 approved only to DN25 (R1")</td> </tr> </tbody> </table>	PN	G	PN 100	G 1/4	PN 100	G 3/8	PN 250	G 1/2	PN 175	G 3/4	PN 63	G 1 to DIN 4755, Part 2 approved only to DN25 (R1")						
PN	G																		
PN 100	G 1/4																		
PN 100	G 3/8																		
PN 250	G 1/2																		
PN 175	G 3/4																		
PN 63	G 1 to DIN 4755, Part 2 approved only to DN25 (R1")																		

No.	Dénomination																		
	<p>Filtre double avec cartouche étoile, mailles 0,1 mm et aimant (utilisation uniquement avec brûleur multiflam)</p> <table border="1"> <thead> <tr> <th>Type</th> <th>DN</th> <th>PN</th> <th>Surface filtrante brute en cm²</th> <th>Débit l/h* FOD</th> </tr> </thead> <tbody> <tr> <td>2.04.5</td> <td>25</td> <td>40</td> <td>2 x 652</td> <td>3000</td> </tr> </tbody> </table> <p>* Les débits indiqués sont valables pour le montage dans la conduite HP, lors du montage sur l'aspiration on ne peut admettre que la moitié de ces valeurs. Lors de la détermination il a été choisi un fioul avec une viscosité de 380 cSt à 50 °C .</p>	Type	DN	PN	Surface filtrante brute en cm ²	Débit l/h* FOD	2.04.5	25	40	2 x 652	3000								
Type	DN	PN	Surface filtrante brute en cm ²	Débit l/h* FOD															
2.04.5	25	40	2 x 652	3000															
1.116	<p>Système de dégazage FloCo-TOP/K avec filtre V 500 Si, pour un fonctionnement mono-tube avec support, filtre fritté 50µ</p> <p>Raccordements : côté cuve : 1 x G3/8 i côté brûleur : 2 x G3/8 a pour raccordement flexibles</p> <p>Puissance gicleur : max. 100 l/h Débit max retour : max. 120 l/h Température de service : max. 60 °C Pression de service : max. 0,7 bar</p>																		
1.117	<p>Élément filtrant fritté 50µ, jaune, avec fermeture à baïonnette pour Nr. 662 031</p>																		
	<p>Pièces pour filtre fioul (sans photo)</p>																		
1.119	<p>Cartouche filtrante pour filtre type F 95, F 95 E, F150, F150 E F200 E</p>																		
1.120	<p>Joint pour tous filtres F</p>																		
1.121	<p>Cartouche chauffante (tensions spéciales sur demande) pour filtres F95 E, F 150 E, 230V, 55W F 200 E, 230V, 66W</p>																		
1.122	<p>Joint Viton pour filtre Type 2.04.5 50 x 67 x 1,5, DN 25/DN 32 62 x 84 x 1,5, DN 40 78 x 94 x 1,5, DN 50 90 x 110 x 1,5, DN 65</p>																		
1.123	<p>Joint torique 69,4 x 3,53 pour couvercle filtre DN 25/32 88,49 x 3,53 pour couvercle filtre DN 40/50</p>																		
	<p>Préfiltre</p>																		
1.124	<p>Préfiltre, DN25, PN40, exécution à brides en fonte d'acier et inox</p>																		
	<p>1.2 Organes d'isolement fioul</p>																		
1.202	<p>Robinet PN40, pour FOL Corps et bille : laiton chromé, joints en Teflon, avec taraudage selon DIN ISO 228/1</p> <table border="1"> <thead> <tr> <th>Typ</th> <th>DN</th> </tr> </thead> <tbody> <tr> <td>984-D</td> <td>Rp 1/4</td> </tr> <tr> <td>984-D</td> <td>Rp 3/8</td> </tr> <tr> <td>984-D</td> <td>Rp 1/2</td> </tr> <tr> <td>984-D</td> <td>Rp 3/4</td> </tr> <tr> <td>984-D</td> <td>Rp 1 selon DIN 4755, pièce uniquement admissible jusqu'à DN25 (G 1)</td> </tr> <tr> <td>984-D</td> <td>Rp 1 1/4</td> </tr> <tr> <td>984-D</td> <td>Rp 1 1/2</td> </tr> <tr> <td>984-D</td> <td>Rp 2</td> </tr> </tbody> </table>	Typ	DN	984-D	Rp 1/4	984-D	Rp 3/8	984-D	Rp 1/2	984-D	Rp 3/4	984-D	Rp 1 selon DIN 4755, pièce uniquement admissible jusqu'à DN25 (G 1)	984-D	Rp 1 1/4	984-D	Rp 1 1/2	984-D	Rp 2
Typ	DN																		
984-D	Rp 1/4																		
984-D	Rp 3/8																		
984-D	Rp 1/2																		
984-D	Rp 3/4																		
984-D	Rp 1 selon DIN 4755, pièce uniquement admissible jusqu'à DN25 (G 1)																		
984-D	Rp 1 1/4																		
984-D	Rp 1 1/2																		
984-D	Rp 2																		
1.203	<p>Robinet à bille pour FOL Corps : acier; à partir de G 1 1/4"; GGG 40; bille : acier chromage dur ; Joints en Teflon, avec taraudage selon DIN ISO 228/1</p> <table border="1"> <thead> <tr> <th>PN</th> <th>G</th> </tr> </thead> <tbody> <tr> <td>PN 100</td> <td>G 1/4</td> </tr> <tr> <td>PN 100</td> <td>G 3/8</td> </tr> <tr> <td>PN 250</td> <td>G 1/2</td> </tr> <tr> <td>PN 175</td> <td>G 3/4</td> </tr> <tr> <td>PN 63</td> <td>G 1 selon DIN 4755, partie 2 uniquement admissible jusqu'à DN25 (R1")</td> </tr> </tbody> </table>	PN	G	PN 100	G 1/4	PN 100	G 3/8	PN 250	G 1/2	PN 175	G 3/4	PN 63	G 1 selon DIN 4755, partie 2 uniquement admissible jusqu'à DN25 (R1")						
PN	G																		
PN 100	G 1/4																		
PN 100	G 3/8																		
PN 250	G 1/2																		
PN 175	G 3/4																		
PN 63	G 1 selon DIN 4755, partie 2 uniquement admissible jusqu'à DN25 (R1")																		

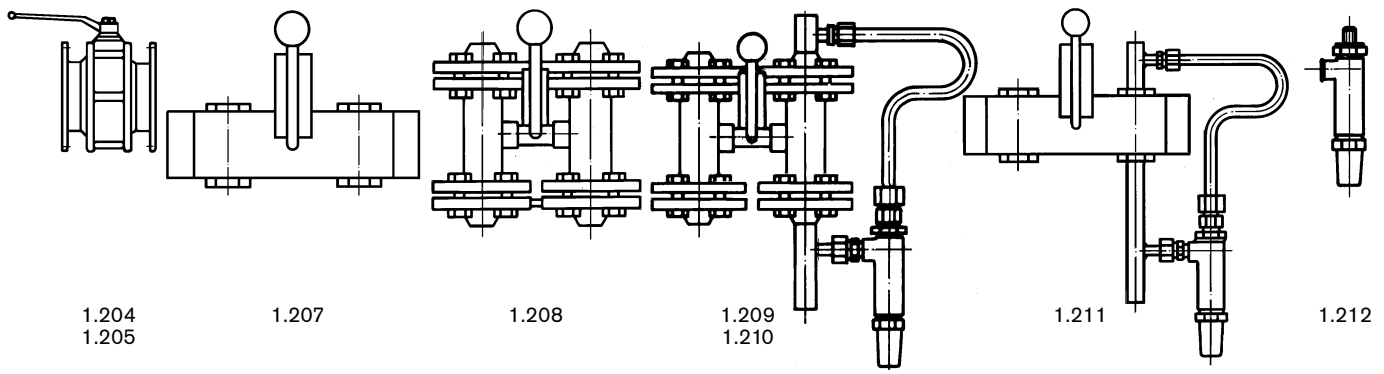

Nr.	Bezeichnung	Bestell-Nr. Order No. N° de commande	Preis EUR (o. MwSt.)
1.204	Kugelhahn PN25 für Heizöl EL und S, Dichtung Teflon, max. 160°C für Ölversorgungsleitungen < 10 bar, Gehäuse Stahl		
	DN 20	454 185	
	DN 25	454 186	
	DN 32	454 147	
	DN 40	454 172	
	DN 50	454 173	
	DN 65	454 174	
1.205	Kugelhahn PN40 für Heizöl EL und S, Dichtung Teflon, max. 160°C für Ölversorgungsleitungen < 40 bar, Gehäuse Stahl		
	DN 20	454 132	
	DN 25	454 133	
	DN 32	454 134	
	DN 40	454 136	
	DN 50	454 137	
1.206	Dichtung (Universal N, blau) nach DIN 2690 (ohne Bild)		
	DN 20, PN40 28 x 60 x 2	441 857	
	DN 25, PN40 35 x 70 x 2	441 858	
	DN 32, PN40 43 x 82 x 2	441 856	
	DN 40, PN40 49 x 92 x 2	441 859	
	DN 50, PN40 61 x 107 x 2	441 860	
	DN 65, PN40 77 x 127 x 2	441 861	
1.207	Absperrkombination , für Heizöl EL und S, PN40 (nicht für Anlagen nach TRD geeignet)		
	G 3/8, Dichtung Teflon	109 000 0081 2	
	G 1/2, Dichtung Teflon	109 000 0082 2	
	G 1, Dichtung Teflon	109 000 0083 2	
	Diese Absperrkombinationen sind mechanisch gekoppelt und zusätzlich mit einem Endschalter versehen.		
1.208	Absperrkombination für Heizöl EL und S mit Gegenflanschen, Dichtungen und Schrauben für Ölversorgungsleitungen PN10		
	DN 20, Dichtung Teflon	109 000 0060 2	
	DN 25, Dichtung Teflon	109 000 0062 2	
	DN 32, Dichtung Teflon	109 000 0064 2	
	DN 50, Dichtung Teflon	109 000 0066 2	
	Diese Absperrkombinationen sind mechanisch gekoppelt und zusätzlich mit einem Endschalter versehen. Für Anlagen nach TRD geeignet.		
1.209	Absperrkombination für Heizöl EL und S mit Sicherheitsventil mit Gegenflanschen, Dichtungen und Schrauben, für Ölversorgungsleitung PN10		
	DN 20, Dichtung Teflon	109 000 0158 2	
	DN 25, Dichtung Teflon	109 000 0143 2	
	DN 32, Dichtung Teflon	109 000 0145 2	
	DN 50, Dichtung Teflon	109 000 0147 2	
	Diese Absperrkombinationen sind mechanisch gekoppelt und zusätzlich mit einem Endschalter versehen, z.B. für WK-Brenner mit separater Pumpe Für Anlagen nach TRD geeignet.		
1.210	Absperrkombination mit Sicherheitsventil mit Gegenflanschen, Dichtungen (nicht für WK mit W-FM) und Schrauben für Druckleitungen PN40 im Vorlauf und im Rücklauf		
	DN 20, Dichtung Teflon für Heizöl EL, M und S	109 000 0326 2	
	DN 25, Dichtung Teflon für Heizöl EL, M und S	109 000 0327 2	
	Absperrkombination DN20 PN40 WK 40, 50, WK4 mit Sicherheitsventil für Heizöl EL, M und S, Gehäuse Stahl, nur in Verbindung mit W-FM einsetzbar	109 000 0622 2	
	Absperrkombination DN25 PN40 WK 70-80, WK4 mit Sicherheitsventil für Heizöl EL, M und S, Gehäuse Stahl, nur in Verbindung mit W-FM einsetzbar. Alle für Anlagen nach TRD geeignet.	109 000 0623 2	
1.211	Absperrkombination mit Sicherheitsventil und Endschalter, PN 40 für Heizöl EL und S, (nicht für Anlagen nach TRD geeignet)		
	G 1/2	109 000 0463 2	
	G1	109 000 0180 2	
	Diese Absperrkombinationen sind mechanisch gekoppelt und zusätzlich mit einem Endschalter versehen.		
1.212	Sicherheitsventil G 1/2, PN 320, Typ 4373 Einstellung: 1,8 bar	640 270	
1.213	Endschalter XCK-P2110 P16, 3A, 240V, IP66 (o. Bild)	700 944	
1.214	Dreiwege-Kugelhahn , DN20, PN40 (Doppel-Ausführung) (ohne Bild) mit Endschalter	454 623	
	DN25, PN40 (Doppel-Ausführung) (ohne Bild)	454 620	
	G3/4, PN40 (Doppel-Ausführung) (ohne Bild)	454 624	
	G1, PN40 (Doppel-Ausführung) (ohne Bild)	454 625	

No.	Description	No.	Dénomination
1.204	Ball valve PN25 for fuel oil EL and S, Teflon seal, max. 160 °C for oil supply lines < 10 bar, steel casing DN 20 DN 25 DN 32 DN 40 DN 50 DN 65	1.204	Robinet à bille PN25 pour FOD et FOL, joint Teflon, max. 160 °C pour conduites fioul < 10 bar, corps en acier DN 20 DN 25 DN 32 DN 40 DN 50 DN 65
1.205	Ball valve PN40 for fuel oil EL and S, Teflon seal, max. 160 °C for oil supply lines < 40 bar, steel casing DN 20 DN 25 DN 32 DN 40 DN 50	1.205	Robinet à bille PN40 pour FOD et FOL, joint Teflon, max. 160 °C pour conduites fioul < 40 bar, corps en acier DN 20 DN 25 DN 32 DN 40 DN 50
1.206	Sealing Universal N , blue (without picture) DN 20, PN40 28 x 60 x 2 DN 25, PN40 35 x 70 x 2 DN 32, PN40 43 x 82 x 2 DN 40, PN40 49 x 92 x 2 DN 50, PN40 61 x 107 x 2 DN 65, PN40 77 x 127 x 2	1.206	Joint (universel N, bleu) selon DIN 2690 (sans photo) DN 20, PN40 28 x 60 x 2 DN 25, PN40 35 x 70 x 2 DN 32, PN40 43 x 82 x 2 DN 32, PN40 43 x 82 x 2 DN 50, PN40 61 x 107 x 2 DN 65, PN40 77 x 127 x 2
1.207	Shut off combination , for fuel oil EL and S, PN40 (not suitable for TRD) G3/8, Teflon seal G1/2, Teflon seal G1, Teflon seal These shut off devices are connected mechanically and are fitted with a limit switch.	1.207	Robinets couplés , pour FOD et FOL, PN40 (non adapté pour installations TRD) G 3/8, joint Teflon G 1/2, joint Teflon G 1, joint Teflon Ces robinets sont couplés mécaniquement et équipés d'un fin de course d'asservissement.
1.208	Shut off combination , for fuel oil EL and S with counter flange, seal and screws, for oil supply lines PN10 DN 20, Teflon seal DN 25, Teflon seal DN 32, Teflon seal DN 50, Teflon seal These shut off devices are connected mechanically and are fitted with a limit switch. Suitable for installations to TRD.	1.208	Robinets couplés pour FOD et FOL avec contre-brides, joints et vis pour conduites fioul PN10 DN 20, joint Teflon DN 25, joint Teflon DN 32, joint Teflon DN 50, joint Teflon Ces robinets sont couplés mécaniquement et équipés d'un fin de course d'asservissement. Adapté pour des installations selon TRD.
1.209	Shut off combination , for fuel oil EL and S with safety valve, with counter flange, seal and screws, for oil supply lines PN10 DN 20, Teflon seal DN 25, Teflon seal DN 32, Teflon seal DN 50, Teflon seal These shut off devices are connected mechanically and are fitted with a limit switch, for example for WK burners with separate pump. Suitable for installations to TRD.	1.209	Robinets couplés pour FOD et FOL avec vanne de sécurité avec contre-brides, joints et vis, pour conduites fioul PN10 DN 20, joint Teflon DN 25, joint Teflon DN 32, joint Teflon DN 50, joint Teflon Ces robinets sont couplés mécaniquement et équipés d'un fin de course d'asservissement, par ex. pour brûleurs WK avec une pompe séparée. Adapté pour des installations selon TRD.
1.210	Shut off combination , with safety valve with counterflange, seals (not for WK with W-FM) and screws for pressure lines PN40 in supply and return DN20, Teflon seal for fuel oil EL, M and S DN25, Teflon seal for fuel oil EL, M and S Shut off combination , DN20 PN40 WK 40, 50, WK4 with safety valve for fuel oil EL, M and S, steel casing, can only be used with W-FM. Shut off combination , DN25 PN40 WK 70-80, WK4 with safety valve for fuel oil EL, M and S, steel casing, can only be used with W-FM. Suitable for all installations to TRD.	1.210	Robinets couplés avec vanne de sécurité avec contre-brides, joints (pas WK équipé de W-FM) et vis pour conduites HP PN40 sur le départ et le retour DN 20, joint Teflon pour FOD et FOL DN 25, joint Teflon pour FOD et FOL Robinets couplés DN20 PN40 WK 40, 50, WK4 avec vanne de sécurité pour FOD et FOL, corps en acier, uniquement avec un W-FM. Robinets couplés DN25 PN40 WK 70-80, WK4 avec vanne de sécurité pour FOD et FOL, corps en acier, uniquement avec W-FM. Adapté pour toutes les installations selon TRD.
1.211	Shut off combination , with safety valve and limit switch, PN40 for fuel oil EL and S, (not suitable for installations to TRD) G1/2 G1 These shut off devices are connected mechanically and are fitted with a limit switch.	1.211	Robinets couplés avec vanne de sécurité et fin de course, PN 40 pour FOD et FOL, (non adapté pour installations TRD) G 1/2 G1 Ces robinets sont couplés mécaniquement et équipés d'un fin de course d'asservissement.
1.212	Safety valve G 1/2, PN 320, type 4373 Setting: 1.8 bar	1.212	Vanne de sécurité G 1/2, PN 320, Typ 4373 Réglage: 1,8 bar
1.213	Limit switch XCK-P2110 P16, 3A, 240V, IP66 (without picture)	1.213	Fin de course XCK-P2110 P16, 3A, 240V, IP66 (sans photo)
1.214	Three way ball valve , DN20, PN40 (double version) (without picture) with limit switch DN25, PN 40 G3/4, PN40 G1, PN40	1.214	Robinet à bille à trois voies , DN20, PN40 (exécution double) (sans photo) avec fin de course DN25, PN40 G3/4, PN40 G1, PN40

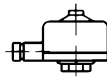
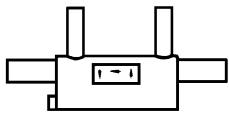

1.301
1.302

1.401

1.404

Nr.	Bezeichnung	Bestell-Nr. Order No. N° de commande	Preis EUR (o. MwSt.)																																												
1.3	Gas-Luft-Abscheider																																														
1.301	Gas-Luft-Abscheider zum Einbau in die Ringleitung. Brenner saugt damit nur blasenfreies Öl an.																																														
	<table border="1"> <thead> <tr> <th>Baugröße</th> <th>Ringleitung Anschluss DN</th> <th>entspricht DN</th> <th>Brennerabgang * DN</th> <th>entspricht DN</th> <th>Heizöl EL l/h</th> <th>Heizöl S l/h</th> </tr> </thead> <tbody> <tr> <td>1</td> <td>33,7</td> <td>25</td> <td>33,7</td> <td>25</td> <td>1000</td> <td>-</td> </tr> <tr> <td>2</td> <td>48,3</td> <td>40</td> <td>33,7</td> <td>25</td> <td>3000</td> <td>2000</td> </tr> <tr> <td>3</td> <td>60,3</td> <td>50</td> <td>42,4</td> <td>32</td> <td>5000</td> <td>3500</td> </tr> <tr> <td>4</td> <td>76,1</td> <td>65</td> <td>48,3</td> <td>40</td> <td>9000</td> <td>6000</td> </tr> </tbody> </table>	Baugröße	Ringleitung Anschluss DN	entspricht DN	Brennerabgang * DN	entspricht DN	Heizöl EL l/h	Heizöl S l/h	1	33,7	25	33,7	25	1000	-	2	48,3	40	33,7	25	3000	2000	3	60,3	50	42,4	32	5000	3500	4	76,1	65	48,3	40	9000	6000											
Baugröße	Ringleitung Anschluss DN	entspricht DN	Brennerabgang * DN	entspricht DN	Heizöl EL l/h	Heizöl S l/h																																									
1	33,7	25	33,7	25	1000	-																																									
2	48,3	40	33,7	25	3000	2000																																									
3	60,3	50	42,4	32	5000	3500																																									
4	76,1	65	48,3	40	9000	6000																																									
1.302	Gas-Luft-Abscheider für Anlagen nach TRD																																														
	<table border="1"> <thead> <tr> <th>Baugröße</th> <th>Ringleitung Anschluss DN</th> <th>entspricht DN</th> <th>Brennerabgang DN</th> <th>entspricht DN</th> <th>Heizöl EL l/h</th> <th>Heizöl S l/h</th> </tr> </thead> <tbody> <tr> <td>1</td> <td>33,7</td> <td>25</td> <td>33,7</td> <td>25</td> <td>1000</td> <td>-</td> </tr> <tr> <td>2</td> <td>48,3</td> <td>40</td> <td>33,7</td> <td>25</td> <td>3000</td> <td>2000</td> </tr> <tr> <td>3</td> <td>60,3</td> <td>50</td> <td>42,4</td> <td>32</td> <td>5000</td> <td>3500</td> </tr> <tr> <td>4</td> <td>76,1</td> <td>65</td> <td>48,3</td> <td>40</td> <td>9000</td> <td>6000</td> </tr> <tr> <td>5</td> <td>88,9</td> <td>80</td> <td>60,3</td> <td>50</td> <td>15000</td> <td>9000</td> </tr> </tbody> </table> <p>Zulässig nach TRD. Die Schweißverbindungen mit dem Rohrsystem müssen von Schweißern hergestellt sein, die ein gültiges Prüfzeugnis nach DIN 8560 mindestens der Gruppe R II f bzw. m besitzen. Die Baugröße der Gas-Luft-Abscheider ist nach der Nennweite der Ringleitung festzulegen. Das heißt, der Anschluss-Querschnitt der Gas-Luft-Abscheider wird in dieser Nennweite, die Brennerabgänge entsprechend der erforderlichen Brenner-Vor- und Rücklaufs ausgewählt. * Ausführungen können bauseits entsprechend reduziert werden.</p>	Baugröße	Ringleitung Anschluss DN	entspricht DN	Brennerabgang DN	entspricht DN	Heizöl EL l/h	Heizöl S l/h	1	33,7	25	33,7	25	1000	-	2	48,3	40	33,7	25	3000	2000	3	60,3	50	42,4	32	5000	3500	4	76,1	65	48,3	40	9000	6000	5	88,9	80	60,3	50	15000	9000				
Baugröße	Ringleitung Anschluss DN	entspricht DN	Brennerabgang DN	entspricht DN	Heizöl EL l/h	Heizöl S l/h																																									
1	33,7	25	33,7	25	1000	-																																									
2	48,3	40	33,7	25	3000	2000																																									
3	60,3	50	42,4	32	5000	3500																																									
4	76,1	65	48,3	40	9000	6000																																									
5	88,9	80	60,3	50	15000	9000																																									
1.303	Gas-Luft-Abscheider für Einstrang (mit Sicherheitsventil und Entlüftungshahn) Baugröße 3 Baugröße 5																																														
			109 000 0378 2 109 000 0627 2																																												
1.4	Begleitheizung																																														
1.401	Wärme kabel als Begleitheizung für Ölleitungen, erforderlich ca. 2 m Heizkabel je m zu beheizendes Rohr. Maximale Oberflächentemperatur 160°C. Silikonkautschukmantel mit Armierung aus Edelstahldrahtgeflecht. Länge der Kaltenden 500 mm.																																														
	<table border="1"> <thead> <tr> <th>Typ</th> <th>Länge ca. m</th> <th>Leistung Watt</th> <th>Anschlussspannung V</th> </tr> </thead> <tbody> <tr> <td rowspan="16">GSISI/V2A</td> <td>10</td> <td>356</td> <td>400</td> </tr> <tr> <td>10</td> <td>278</td> <td>230</td> </tr> <tr> <td>15</td> <td>352</td> <td>230</td> </tr> <tr> <td>20</td> <td>661</td> <td>230</td> </tr> <tr> <td>25</td> <td>705</td> <td>230</td> </tr> <tr> <td>30</td> <td>881</td> <td>230</td> </tr> <tr> <td>35</td> <td>755</td> <td>230</td> </tr> <tr> <td>40</td> <td>1017</td> <td>230</td> </tr> <tr> <td>50</td> <td>1469</td> <td>230</td> </tr> <tr> <td>55</td> <td>1336</td> <td>230</td> </tr> <tr> <td>60</td> <td>1356</td> <td>230</td> </tr> <tr> <td>70</td> <td>2099</td> <td>230</td> </tr> <tr> <td>80</td> <td>2645</td> <td>230</td> </tr> </tbody> </table> <p>Andere Wärme kabel- bzw. Anschlussenden-Längen sowie Spannungen auf Anfrage</p>	Typ	Länge ca. m	Leistung Watt	Anschlussspannung V	GSISI/V2A	10	356	400	10	278	230	15	352	230	20	661	230	25	705	230	30	881	230	35	755	230	40	1017	230	50	1469	230	55	1336	230	60	1356	230	70	2099	230	80	2645	230		745 149 745 150 745 151 745 152 745 153 745 154 745 155 745 156 745 158 745 159 745 160 745 162 745 164
Typ	Länge ca. m	Leistung Watt	Anschlussspannung V																																												
GSISI/V2A	10	356	400																																												
	10	278	230																																												
	15	352	230																																												
	20	661	230																																												
	25	705	230																																												
	30	881	230																																												
	35	755	230																																												
	40	1017	230																																												
	50	1469	230																																												
	55	1336	230																																												
	60	1356	230																																												
	70	2099	230																																												
	80	2645	230																																												
	1.402	Schlauchband zur Befestigung des Wärme kabels, Rolle 9 mm breit, 25 m lang (ohne Bild)	verzinkt (für Stahlrohre) Edelstahl (für Kupferrohre)	499 105 499 104																																											
	1.403	Schlauchschloss für Schlauchband 9,5 mm x 14,5 mm (ohne Bild) (ca. 3 Stück pro Meter) Edelstahl		109 000 0030 7																																											
	1.404	Temperaturregler Typ GAT/7 HC AN 67 403 Gehäuse- Anlegethermostat, Arbeitsbereich 10/90 °C, Verstellung innenliegend		690 439																																											
1.405	Temperaturregler ATHS-1 20-150°, IP54, Tauchrohr V4A G 1/2 x 8 mm, Länge 100 mm		690 270																																												

No.	Description																																												
1.3	Air/gas separators																																												
1.301	<p>Air/gas separator for installation into the ring main, to ensure the burner is then supplied with bubble free oil only.</p> <table border="1"> <thead> <tr> <th>Size</th> <th>Ring main connection DN</th> <th>equal to DN</th> <th>Burner outlet* DN</th> <th>equal to DN</th> <th>Fuel oil EL l/h</th> <th>Fuel oil S l/h</th> </tr> </thead> <tbody> <tr> <td>1</td> <td>33.7</td> <td>25</td> <td>33.7</td> <td>25</td> <td>1000</td> <td>–</td> </tr> <tr> <td>2</td> <td>48.3</td> <td>40</td> <td>33.7</td> <td>25</td> <td>3000</td> <td>2000</td> </tr> <tr> <td>3</td> <td>60.3</td> <td>50</td> <td>42.4</td> <td>32</td> <td>5000</td> <td>3500</td> </tr> <tr> <td>4</td> <td>76.1</td> <td>65</td> <td>48.3</td> <td>40</td> <td>9000</td> <td>6000</td> </tr> </tbody> </table>	Size	Ring main connection DN	equal to DN	Burner outlet* DN	equal to DN	Fuel oil EL l/h	Fuel oil S l/h	1	33.7	25	33.7	25	1000	–	2	48.3	40	33.7	25	3000	2000	3	60.3	50	42.4	32	5000	3500	4	76.1	65	48.3	40	9000	6000									
Size	Ring main connection DN	equal to DN	Burner outlet* DN	equal to DN	Fuel oil EL l/h	Fuel oil S l/h																																							
1	33.7	25	33.7	25	1000	–																																							
2	48.3	40	33.7	25	3000	2000																																							
3	60.3	50	42.4	32	5000	3500																																							
4	76.1	65	48.3	40	9000	6000																																							
1.302	<p>Air/gas separator for installations to TRD</p> <table border="1"> <thead> <tr> <th>Size</th> <th>Ring main connection DN</th> <th>equal to DN</th> <th>Burner outlet* DN</th> <th>equal to DN</th> <th>Fuel oil EL l/h</th> <th>Fuel oil S l/h</th> </tr> </thead> <tbody> <tr> <td>1</td> <td>33.7</td> <td>25</td> <td>33.7</td> <td>25</td> <td>1000</td> <td>–</td> </tr> <tr> <td>2</td> <td>48.3</td> <td>40</td> <td>33.7</td> <td>25</td> <td>3000</td> <td>2000</td> </tr> <tr> <td>3</td> <td>60.3</td> <td>50</td> <td>42.4</td> <td>32</td> <td>5000</td> <td>3500</td> </tr> <tr> <td>4</td> <td>76.1</td> <td>65</td> <td>48.3</td> <td>40</td> <td>9000</td> <td>6000</td> </tr> <tr> <td>5</td> <td>88.9</td> <td>80</td> <td>60.3</td> <td>50</td> <td>15000</td> <td>9000</td> </tr> </tbody> </table> <p>Approved to TRD. The size of the air/gas separator depends on the nominal bore of the ring main, the air/gas separator is selected having the same nominal bore connections. The burner connections are selected relative to the burner supply and return. *Sizes can be reduced on site as required.</p>	Size	Ring main connection DN	equal to DN	Burner outlet* DN	equal to DN	Fuel oil EL l/h	Fuel oil S l/h	1	33.7	25	33.7	25	1000	–	2	48.3	40	33.7	25	3000	2000	3	60.3	50	42.4	32	5000	3500	4	76.1	65	48.3	40	9000	6000	5	88.9	80	60.3	50	15000	9000		
Size	Ring main connection DN	equal to DN	Burner outlet* DN	equal to DN	Fuel oil EL l/h	Fuel oil S l/h																																							
1	33.7	25	33.7	25	1000	–																																							
2	48.3	40	33.7	25	3000	2000																																							
3	60.3	50	42.4	32	5000	3500																																							
4	76.1	65	48.3	40	9000	6000																																							
5	88.9	80	60.3	50	15000	9000																																							
1.303	<p>Air/Gas separator for single pipe installation (with safety and vent valves) Size 3 Size 5</p>																																												
1.4	Line heating																																												
1.401	<p>Heating cable For oil line heating, allow approx. 2 m of cable per 1 m of pipe. Maximum surface temperature 160 °C. Silicon cover with reinforcement made of galvanized steel wire mesh. Cold connection ends 500 mm long.</p> <table border="1"> <thead> <tr> <th>Type</th> <th>Length m (approx.)</th> <th>Capacity Watt</th> <th>Connection voltage V</th> </tr> </thead> <tbody> <tr> <td rowspan="16">GSISI/V2A</td> <td>10</td> <td>356</td> <td>400</td> </tr> <tr> <td>10</td> <td>278</td> <td>230</td> </tr> <tr> <td>15</td> <td>352</td> <td>230</td> </tr> <tr> <td>20</td> <td>661</td> <td>230</td> </tr> <tr> <td>25</td> <td>705</td> <td>230</td> </tr> <tr> <td>30</td> <td>881</td> <td>230</td> </tr> <tr> <td>35</td> <td>755</td> <td>230</td> </tr> <tr> <td>40</td> <td>1017</td> <td>230</td> </tr> <tr> <td>50</td> <td>1469</td> <td>230</td> </tr> <tr> <td>55</td> <td>1336</td> <td>230</td> </tr> <tr> <td>60</td> <td>1356</td> <td>230</td> </tr> <tr> <td>70</td> <td>2099</td> <td>230</td> </tr> <tr> <td>80</td> <td>2645</td> <td>230</td> </tr> </tbody> </table> <p>Other heating cable, connection end lengths and voltages on request.</p>	Type	Length m (approx.)	Capacity Watt	Connection voltage V	GSISI/V2A	10	356	400	10	278	230	15	352	230	20	661	230	25	705	230	30	881	230	35	755	230	40	1017	230	50	1469	230	55	1336	230	60	1356	230	70	2099	230	80	2645	230
Type	Length m (approx.)	Capacity Watt	Connection voltage V																																										
GSISI/V2A	10	356	400																																										
	10	278	230																																										
	15	352	230																																										
	20	661	230																																										
	25	705	230																																										
	30	881	230																																										
	35	755	230																																										
	40	1017	230																																										
	50	1469	230																																										
	55	1336	230																																										
	60	1356	230																																										
	70	2099	230																																										
	80	2645	230																																										
	1.402	<p>Band for attaching the heating cable. Roll 9 mm wide, 25 m long (without picture)</p>																																											
	1.403	<p>Band fastener 9.5 mm x 14.5 mm (without picture) (approx. 3 pieces per metre)</p>																																											
	1.404	<p>Temperature controller type GAT/7HC AN 67 403 contact thermostat, operating range 10 °C to 90 °C, with internal adjustment</p>																																											
1.405	<p>Temperature controller ATHS-1 20 °C -150 °C, IP54, thermostat pocket V4A G 1/2 x 8 mm, length 100 mm</p>																																												

No.	Dénomination																																												
1.3	Pot de dégazage																																												
1.301	<p>Pot de dégazage à incorporer dans la boucle de transfert. Par conséquent, le brûleur n'aspire que du fioul sans bulles.</p> <table border="1"> <thead> <tr> <th>Taille</th> <th>Racc. boucle à DN</th> <th>correspond à DN</th> <th>Sortie vers brûleur * à DN</th> <th>correspond à DN</th> <th>FOD l/h</th> <th>FOL l/h</th> </tr> </thead> <tbody> <tr> <td>1</td> <td>33,7</td> <td>25</td> <td>33,7</td> <td>25</td> <td>1000</td> <td>–</td> </tr> <tr> <td>2</td> <td>48,3</td> <td>40</td> <td>33,7</td> <td>25</td> <td>3000</td> <td>2000</td> </tr> <tr> <td>3</td> <td>60,3</td> <td>50</td> <td>42,4</td> <td>32</td> <td>5000</td> <td>3500</td> </tr> <tr> <td>4</td> <td>76,1</td> <td>65</td> <td>48,3</td> <td>40</td> <td>9000</td> <td>6000</td> </tr> </tbody> </table>	Taille	Racc. boucle à DN	correspond à DN	Sortie vers brûleur * à DN	correspond à DN	FOD l/h	FOL l/h	1	33,7	25	33,7	25	1000	–	2	48,3	40	33,7	25	3000	2000	3	60,3	50	42,4	32	5000	3500	4	76,1	65	48,3	40	9000	6000									
Taille	Racc. boucle à DN	correspond à DN	Sortie vers brûleur * à DN	correspond à DN	FOD l/h	FOL l/h																																							
1	33,7	25	33,7	25	1000	–																																							
2	48,3	40	33,7	25	3000	2000																																							
3	60,3	50	42,4	32	5000	3500																																							
4	76,1	65	48,3	40	9000	6000																																							
1.302	<p>Pot de dégazage pour installations selon TRD</p> <table border="1"> <thead> <tr> <th>Taille</th> <th>Racc. boucle à DN</th> <th>correspond à DN</th> <th>Sortie vers brûleur * à DN</th> <th>correspond à DN</th> <th>FOD l/h</th> <th>FOL l/h</th> </tr> </thead> <tbody> <tr> <td>1</td> <td>33,7</td> <td>25</td> <td>33,7</td> <td>25</td> <td>1000</td> <td>–</td> </tr> <tr> <td>2</td> <td>48,3</td> <td>40</td> <td>33,7</td> <td>25</td> <td>3000</td> <td>2000</td> </tr> <tr> <td>3</td> <td>60,3</td> <td>50</td> <td>42,4</td> <td>32</td> <td>5000</td> <td>3500</td> </tr> <tr> <td>4</td> <td>76,1</td> <td>65</td> <td>48,3</td> <td>40</td> <td>9000</td> <td>6000</td> </tr> <tr> <td>5</td> <td>88,9</td> <td>80</td> <td>60,3</td> <td>50</td> <td>15000</td> <td>9000</td> </tr> </tbody> </table> <p>Conforme pour TRD. Les raccordements par soudure avec les tuyaux doivent être réalisés par du personnel titulaire d'une licence de soudure selon DIN 8560 (minimum groupe RII). La taille des pots de dégazage doit être déterminée en fonction du diamètre de la boucle de transfert. Cela signifie que le pot de dégazage aura le diamètre de la boucle de transfert et le diamètre des raccordements vers le brûleur seront déterminés en fonction du pot de dégazage retenu. * Réduction des exécutions possible par le constructeur.</p>	Taille	Racc. boucle à DN	correspond à DN	Sortie vers brûleur * à DN	correspond à DN	FOD l/h	FOL l/h	1	33,7	25	33,7	25	1000	–	2	48,3	40	33,7	25	3000	2000	3	60,3	50	42,4	32	5000	3500	4	76,1	65	48,3	40	9000	6000	5	88,9	80	60,3	50	15000	9000		
Taille	Racc. boucle à DN	correspond à DN	Sortie vers brûleur * à DN	correspond à DN	FOD l/h	FOL l/h																																							
1	33,7	25	33,7	25	1000	–																																							
2	48,3	40	33,7	25	3000	2000																																							
3	60,3	50	42,4	32	5000	3500																																							
4	76,1	65	48,3	40	9000	6000																																							
5	88,9	80	60,3	50	15000	9000																																							
1.303	<p>Pot de dégazage pour mono-tube (avec vanne sécurité et robinet purge) Taille 3 Taille 5</p>																																												
1.4	Accessoires de réchauffage																																												
1.401	<p>Câbles chauffants Pour le réchauffage des conduites fioul, env. 2 m de câble chauffant par m de câble chauffant. Température maxi en surface 160 °C. Enveloppe en silicone avec armature en treillis de fil d'acier galvanisé. Longueur des bouts de raccordement froids 500 mm.</p> <table border="1"> <thead> <tr> <th>Type</th> <th>Longueur env. m</th> <th>Puissance Watt</th> <th>Tension de r raccord. V</th> </tr> </thead> <tbody> <tr> <td rowspan="16">GSISI/V2A</td> <td>10</td> <td>356</td> <td>400</td> </tr> <tr> <td>10</td> <td>278</td> <td>230</td> </tr> <tr> <td>15</td> <td>352</td> <td>230</td> </tr> <tr> <td>20</td> <td>661</td> <td>230</td> </tr> <tr> <td>25</td> <td>705</td> <td>230</td> </tr> <tr> <td>30</td> <td>881</td> <td>230</td> </tr> <tr> <td>35</td> <td>755</td> <td>230</td> </tr> <tr> <td>40</td> <td>1017</td> <td>230</td> </tr> <tr> <td>50</td> <td>1469</td> <td>230</td> </tr> <tr> <td>55</td> <td>1336</td> <td>230</td> </tr> <tr> <td>60</td> <td>1356</td> <td>230</td> </tr> <tr> <td>70</td> <td>2099</td> <td>230</td> </tr> <tr> <td>80</td> <td>2645</td> <td>230</td> </tr> </tbody> </table> <p>Autres longueurs de câbles chauffants et bouts de raccordement froids ainsi que différentes tensions sur demande.</p>	Type	Longueur env. m	Puissance Watt	Tension de r raccord. V	GSISI/V2A	10	356	400	10	278	230	15	352	230	20	661	230	25	705	230	30	881	230	35	755	230	40	1017	230	50	1469	230	55	1336	230	60	1356	230	70	2099	230	80	2645	230
Type	Longueur env. m	Puissance Watt	Tension de r raccord. V																																										
GSISI/V2A	10	356	400																																										
	10	278	230																																										
	15	352	230																																										
	20	661	230																																										
	25	705	230																																										
	30	881	230																																										
	35	755	230																																										
	40	1017	230																																										
	50	1469	230																																										
	55	1336	230																																										
	60	1356	230																																										
	70	2099	230																																										
	80	2645	230																																										
	1.402	<p>Collier pour fixation du câble chauffant, galvanisé (pour tubes acier) Rouleau 9 mm de large, 25 m de long (sans photo) en acier (pour tubes en cuivre)</p>																																											
	1.403	<p>Fermeture pour collier 9,5 mm x 14,5 mm (sans photo) (env. 3 pièces par mètre) acier</p>																																											
	1.404	<p>Thermostat type GAT/7 HC AN 67 403 Sonde en applique, plage 10/90 °C, réglage intérieur</p>																																											
1.405	<p>Thermostat ATHS-1 20-150°, IP54, tube plongeur V4A G 1/2 x 8 mm, longueur 100 mm</p>																																												

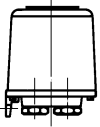

1.504
1.505

Nr.	Bezeichnung	Bestell-Nr. Order No. N° de commande	Preis EUR (o. MwSt.)
1.5	Ölzähleinrichtungen		
1.501	Brenner-Umbausätze mit Ölzähler VZO 4 für Brenner-Typ WL5-PA + PB WL5-B, WL10-D, WL20/1-C, WL20/2-C-Z-1LN WL20/2-C WL20/2-C, Z WGL30/1-A mit Pumpe AL65 L1Z-B L1T-B GL1 VZO 4 RE-Impuls NF 0,1 L WGL30/1-A VZO 4 OEM RE-Impuls HF 0,005 L WL30-C WL30-C-LN WL40Z-A, WL40Z-LN	240 051 0010 0 240 100 0015 0 240 201 0014 0 240 201 0011 0 230 300 8501 2 210 163 8506 2 210 193 8501 2 250 103 8501 2 230 300 8505 2 240 301 0006 0 240 301 0007 0 240 401 0001 0	
1.502	Brenner-Umbausätze mit Ölzähler VZO 8 für Brenner-Typ L1Z-B mit Ferngeber RE L3Z-A (ohne LN) L3Z-A (ohne LN) mit Ferngeber RE L3T-A GL3 (ohne Magnetkupplung) L5Z, GL5, L5T L7Z, L7T, GL7 WM-L10T (nicht bei TRD und 3LN) WM-L10T mit Ferngeber RE (W-FM 50 bis 200, nicht bei TRD und 3LN)	210 163 8510 2 210 363 8509 2 210 363 8510 2 210 393 8501 2 250 301 0032 0 110 501 0007 2 110 701 0005 2 201 101 0003 0 201 101 0004 0	
1.503	Brenner-Umbausätze mit Ölzähler VZO 20 für Brenner-Typ L8Z, L8Z/2 L8Z, L8Z/2 mit Ferngeber L8T, L8T/2 L8T, L8T/2 mit Ferngeber L9Z L9Z mit Ferngeber L9T L9ZT mit Ferngeber L10T L10T mit Ferngeber L30Z, L30T L30Z, L30T mit Ferngeber L40Z, L40T L40Z, L40T mit Ferngeber L50T L50T mit Ferngeber GL8 GL8 mit Ferngeber GL9 GL9 mit Ferngeber GL30T GL30T mit Ferngeber GL40T GL40T mit Ferngeber	110 701 0013 2 110 701 0016 2 110 701 0014 2 110 701 0015 2 110 901 0011 2 110 901 0013 2 110 901 0012 2 110 901 0014 2 180 001 0005 2 180 001 0006 2 280 301 0003 2 280 301 0004 2 280 401 0003 2 280 401 0004 2 280 501 0003 2 280 501 0004 2 150 701 0005 2 150 701 0006 2 150 901 0003 2 150 901 0004 2 290 301 0003 2 290 301 0004 2 290 401 0004 2 290 401 0005 2	
	Ölzähler, lose (ohne Brenner-Anschlusssteile)		
1.504	Typ VZO 4 Bereich 1- 50 l/h, Betriebsdruck max 25 bar, Betriebstemperatur max. 50°C Anschluss Innengewinde G 1/8 Messgenauigkeit ± 1 % Gehäusematerial Messing - mit Ferngeber (NF) RE 0,1 (0,1l/Impuls), 48 V - mit Ferngeber (HF) 0,005L/Impuls	606 044 606 045 606 083	

No.	Description
1.5	Oil meters
1.501	<p>Burner conversion kits with oil meter for burner types</p> <p>VZO 4 WL5-PA + PB WL5-B, WL10-D, WL20/1-C, WL20/2-C-Z-1LN WL20/2-C WL20/2-C, Z WGL30/1-A with pump AL65</p> <p>L1Z-B L1T-B GL1</p> <p>VZO 4 RE-impulse NF 0,1 L WGL30/1-A</p> <p>VZO 4 OEM RE-impulse HF 0,005 L WL30-C WL30-C-LN WL40Z-A, WL40Z-LN</p>
1.502	<p>Burner conversion kits with oil meter for burner types</p> <p>VZO 8 L1Z-B with remote transmitter RE L3Z-A (without LN) L3Z-A (without LN) with remote transmitter RE L3T-A GL3 (without magnetic coupling) L5Z, GL5, L5T L7Z, L7T, GL7 WM-L10T (not for TRD and 3LN) WM-L10T with remote transmitter RE (W-FM 50 to 200 not for TRD and 3LN)</p>
1.503	<p>Burner conversion kits with oil meter for burner types</p> <p>VZO 20 L8Z, L8Z/2 L8Z, L8Z/2 with remote transmitter L8T, L8T/2 L8T, L8T/2 with remote transmitter L9Z L9Z with remote transmitter L9T L9ZT with remote transmitter L10T L10T with remote transmitter</p> <p>L30Z, L30T L30Z, L30T with remote transmitter L40Z, L40T L40Z, L40T with remote transmitter L50T L50T with remote transmitter</p> <p>GL8 GL8 with remote transmitter GL9 GL9 with remote transmitter</p> <p>GL30T GL30T with remote transmitter GL40T GL40T with remote transmitter</p> <p>Oil meter, loose (without connection parts)</p>
1.504	<p>Type VZO 4 range 1 – 50 l/h, operating pressure max. 25 bar, operating temperature max. 50 °C, connection internal thread G 1/8 measuring accuracy ± 1 % housing material brass – with remote transmitter (NF) RE 0.1 (0.1l/impulse), 48V – with remote transmitter HF 0.005l/impulse</p>

No.	Dénomination
1.5	Compteurs fioul
1.501	<p>Ensemble de transformation avec compteur pour brûleur type</p> <p>VZO 4 WL5-PA + PB WL5-B, WL10-D, WL20/1-C, WL20/2-C-Z-1LN WL20/2-C WL20/2-C, Z WGL30/1-A avec pompe AL65</p> <p>L1Z-B L1T-B GL1</p> <p>VZO 4 RE-Impuls NF 0,1 L WGL30/1-A</p> <p>VZO 4 OEM RE-Impuls HF 0,005 L WL30-C WL30-C-LN WL40Z-A, WL40Z-LN</p>
1.502	<p>Ensemble de transformation avec compteur pour brûleur type</p> <p>VZO 8 L1Z-B avec transmetteur à distance RE L3Z-A (sans exéc. LN) L3Z-A (sans exéc. LN) avec transmetteur à distance RE L3T-A GL3 (sans accouplement magnétique) L5Z, GL5, L5T L7Z, L7T, GL7 WM-L10T (pas pour TRD et 3LN) WM-L10T avec transmetteur à distance RE (W-FM 50 jusqu'à 200 pas pour TRD et 3LN)</p>
1.503	<p>Ensemble de transformation avec compteur pour brûleur type</p> <p>VZO 20 L8Z, L8Z/2 L8Z, L8Z/2 avec transmetteur à distance L8T, L8T/2 L8T, L8T/2 avec transmetteur à distance L9Z L9Z avec transmetteur à distance L9T L9ZT avec transmetteur à distance L10T L10T avec transmetteur à distance</p> <p>L30Z, L30T L30Z, L30T avec transmetteur à distance L40Z, L40T L40Z, L40T avec transmetteur à distance L50T L50T avec transmetteur à distance</p> <p>GL8 GL8 avec transmetteur à distance GL9 GL9 avec transmetteur à distance</p> <p>GL30T GL30T avec transmetteur à distance GL40T GL40T avec transmetteur à distance</p> <p>Compteur fioul séparé (sans pièces de racc. brûleur)</p>
1.504	<p>Type VZO 4 Plage 1- 50 l/h, pression de service max 25 bar, Température de service max. 50 °C Raccordement filetage intérieur G 1/8 Précision de la mesure ±1 % Carcasse en laiton – avec transmetteur (BF) RE 0,1 (0,1l/Impuls), 48 V – avec transmetteur HF 0,005L/Impulsion</p>

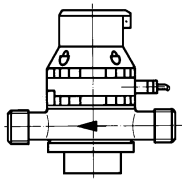

1.506
1.510

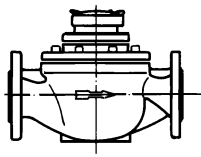

1.507
1.511

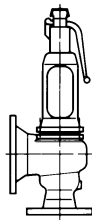

1.513
1.514

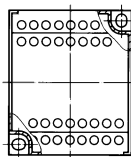

1.515
1.516

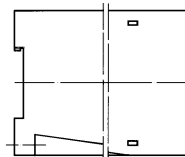

Nr.	Bezeichnung	Bestell-Nr. Order No. N° de commande	Preis EUR (o. MwSt.)
1.505	Typ VZO 8 Bereich 4-180 l/h, Betriebsdruck max 25 bar, Betriebstemperatur max. 60°C Anschluss Innengewinde G 1/4 Messgenauigkeit ± 1 % Gehäusematerial Messing – ohne Ferngeber – mit Ferngeber (NF) RE 1(1 l/Impuls) – mit Ferngeber (HF) RE 0,003111(0,003111 l/Impuls)	606 079 606 081 606 080	
1.506	Typ VZO 20 Bereich 30 - 1.330 l/h, Betriebsdruck max 16 bar, Betriebstemperatur max. 130°C Anschluss Außengewinde G 1 Messgenauigkeit ± 1 % Gehäusematerial Messing – ohne Ferngeber – mit Ferngeber (NF) RV 1 (1 l/Impuls) – mit Ferngeber (HF) IN 0,01 (0,01 l/Impuls)	606 053 606 055 606 054	
1.507	– geflanschte Ausführung DN 20 (ohne Ferngeber) Gehäusematerial Sphäroguss	606 077	
1.510	Typ VZO 25 Bereich 75 - 2000 l/h, Betriebsdruck max 16 bar, Betriebstemperatur max. 130°C Anschluss Außengewinde G 1 1/4 Messgenauigkeit ± 1 % Gehäusematerial Messing – ohne Ferngeber – mit Ferngeber (NF) RV 1 (1 l/Impuls) – mit Ferngeber (HF) IN 0,1 (0,01 l/Impuls)	606 056 606 058 606 057	
1.511	– geflanschte Ausführung DN 25 (ohne Ferngeber) Gehäusematerial Sphäroguss	606 078	
1.512	Steckersatz für Ölzähler VZO	716 029	
1.513	Sicherheitsventil Typ 4593.2512 Eingang: G 3/4 Außengewinde, Ausgang: G 1 Innengewinde Ansprechdruck 1,8 bar, mit Einstellbescheinigung	640 286	
1.514	Sicherheitsventil DN25, PN40 Typ 4412.4512 Eingang: DN25, PN40, Ausgang: DN40, PN16 Ansprechdruck 1,8 bar, mit Einstellbescheinigung für Anlagen nach TRD 604	640 287	
1.515	Relais KFA6-SR2-Ex1. W-LB Typ 4412.4512 mit 2 potentialfreien Relais-Ausgängen für Impulsgeber Typ NF, Versorgungsspannung 230 V, Frequenz 45-65 Hz	606 082	
1.516	Frequenzstromumsetzer Typ KFÜ8-UFC-1D für Impulsgeber Typ HF Versorgungsspannung: 230/115V und 24V DC Eingangsfrequenz: 0,001 Hz ... 12 kHz Analogausgang: 0/4 ... 20 mA Beim Einbau von Heizölmengenzählern in Vor- und Rücklauf (vor der Brenner-Pumpe) muss ein Sicherheitsventil im Rücklauf eingebaut werden. Dies ist notwendig, damit beim Blockieren des Zählers das Öl im Rücklauf überströmen kann, und somit Schäden vermieden werden (siehe Pos. 1.512 und 1.513). Anschluss- und Verbindungsteile für Ausführung nach TRD (o. Bild)	606 084	
1.521	Anschlusssteile VZO20 VZO25	109 000 0242 2 109 000 0243 2	
1.522	Verbindungsteile DN 20 DN 25	151 331 2633 2 151 331 2629 2	
1.523	Doppelnippel G1 A x 165 G1 1/4 A x 190	109 000 0181 7 109 000 0514 7	
1.524	Flansch C 20 x 26,9 DIN 2633 C 25 x 33,7 DIN 2633	452 940 452 941	

No.	Description	No.	Dénomination
1.505	Type VZO 8 range 4 – 180 l/h, operating pressure max. 25 bar operating temperature max. 60 °C, connection internal thread G 1/4 measuring accuracy ± 1 % housing material brass – without remote transmitter – with remote transmitter (NF) RE 1 (1 l/Impuls) – with remote transmitter (HF) RE 0,003111 (0,003111 l/Impuls)	1.505	Type VZO 8 Plage 4-180 l/h, pression de service max 25 bar, Température de service max. 60 °C Raccordement filetage intérieur G 1/4 Précision de la mesure ± 1 % Carcasse en laiton – sans transmetteur – avec transmetteur (BF) RE 1(1 l/Impulsion) – avec transmetteur (HF) RE 0,003111 (0,003111 l/Impuls)
1.506	Type VZO 20 range 30 – 1330 l/h, operating pressure max. 16 bar operating temperature max. 130 °C, connection external thread G 1 measuring accuracy ± 1 % housing material brass – without remote transmitter – with remote transmitter (NF) RV1 (1 l/Impuls) – with remote transmitter (HF) IN 0.01 (0.01 l/Impuls)	1.506	Type VZO 20 Plage 30 - 1.330 l/h, pression de service max 16 bar, Température de service max. 130 °C Raccordement filetage intérieur G 1 Précision de la mesure ± 1 % Carcasse en laiton – sans transmetteur – avec transmetteur (BF) RV 1 (1 l/Impulsion) – avec transmetteur (HF) IN 0,01 (0,01 l/Impulsion)
1.507	– flanged version DN 20 (without remote transmitter) housing material spheroid cast iron	1.507	– exécution à brides DN 20 (sans transmetteur) Carcasse en fonte GS
1.510	Type VZO 25 range 75 – 2000 l/h, operating pressure max. 16 bar, operating temperature max. 130 °C, connection external thread G 1 1/4 measuring accuracy ± 1 % housing material brass – without remote transmitter – with remote transmitter (NF) RV1 (1 l/Impuls) – with remote transmitter (HF) IN 0,1 (0,01 l/Impuls)	1.510	Type VZO 25 Plage 75 - 2000 l/h, pression de service max 16 bar, Température de service max. 130 °C Raccordement filetage intérieur G 1 1/4 Précision de la mesure ± 1 % Carcasse en laiton – sans transmetteur – avec transmetteur (BF) RV 1 (1 l/Impulsion) – avec transmetteur (HF) IN 0,1 (0,01 l/Impulsion)
1.511	– flanged version DN 25 (without remote transmitter) housing material spheroid cast iron	1.511	– exécution à brides DN 25 (sans transmetteur) Carcasse en fonte GS
1.512	Plug set for oil meter VZO	1.512	Connecteur pour compteur fioul VZO
1.513	Safety valve type 4593.2512 Inlet: G3/4 external thread, outlet: G1 internal thread Response pressure 1.8 bar, with calibration certificate	1.513	Soupape de sécurité type 4593.2512 Entrée : G 3/4 filetage extérieur, sortie : G 1 filetage intérieur Pression de fonctionnement 1,8 bar, avec certificat d'étalonnage
1.514	Safety valve DN25, PN40 type 4412.4512 Inlet: DN25, PN40, outlet: DN40, PN16 Response pressure 1.8 bar, with calibration certificate for installations to TRD604	1.514	Soupape de sécurité DN25, PN40 type 4412.4512 Entrée : DN25, PN40, Sortie : DN40, PN16 Pression de fonctionnement 1,8 bar, avec certificat d'étalonnage pour installations selon TRD 604
1.515	Relay KFA6-SR2-Ex1. W-LB type 4412.4512 with two potential free relay outputs for impulse generator type NF, supply voltage 230 V, frequency 45-65 Hz	1.515	Relais KFA6-SR2-Ex1. W-LB type 4412.4512 avec 2 contacts libres de potentiel pour émetteur type BF, tension d'alimentation 230 V, fréquence 45-65 Hz
1.516	Frequency convertor type KFU8-UFC-1D for impulse generator type HF Supply voltage: 230/115 V and 24V DC Input frequency: 0.001 Hz ... 12 kHz Analog output: 0/4 ... 20 mA If an oil quantity meter is fitted in the supply and return line (before the burner pump), a bypass safety valve must be fitted around the meter in the return line. This is necessary for the oil to flow into the return line if the meter is blocked thus avoiding damage (see pos. 1.512 and 1.513).	1.516	Convertisseur de fréquence type KFU8-UFC-1D pour émetteur d'impulsions type HF Tension d'alimentation : 230/115V et 24V DC Fréquence d'entrée : 0,001 Hz ... 12 kHz Sortie analogique : 0/4 ... 20 mA Avant le montage d'un compteur sur le départ et le retour (avant la pompe brûleur) une soupape de sécurité doit être incorporée dans le retour. Ceci est nécessaire afin qu'au blocage du compteur fioul des dégâts soient évités dans le cas d'un éventuel écoulement de fioul. (voir pos. 1.512 et 1.513).
	Connecting parts for TRD (without photo)		Éléments de raccordement pour exécution selon TRD (sans image)
1.521	Connecting parts VZO20 VZO25	1.521	Éléments de raccordement VZO20 VZO25
1.522	Connecting parts DN 20 DN 25	1.522	Éléments de liaison DN 20 DN 25
1.523	Double nipple G1 m x 165 G1 1/4 m x 190	1.523	Mamelon double G1 A x 165 G1 1/4 A x 190
1.524	Flange C 20 x 26,9 DIN 2633 C 25 x 33,7 DIN 2633	1.524	Bride C 20 x 26,9 DIN 2633 C 25 x 33,7 DIN 2633

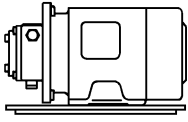

1.601

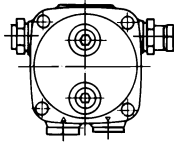

1.602

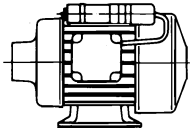

1.604

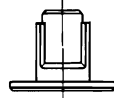

1.605

Nr.	Bezeichnung	Bestell-Nr. Order No. N° de commande	Preis EUR (o. MwSt.)																																																																																																
1.60	Ringleitungsarmaturen / Zubringerpumpe Pumpenaggregat für Heizöl EL (o. Bild), Motor 220V ~, 2800 min ⁻¹ , Motorschutzschalter 1,20A erforderlich																																																																																																		
	<table border="1"> <thead> <tr> <th>Typ</th> <th>Förderstrom Q, l/h</th> <th>Motorleistung kW</th> <th>Anschlusmaße DN</th> </tr> </thead> <tbody> <tr> <td>FTU AE 47C</td> <td>50</td> <td>0,13</td> <td>G 1/4</td> </tr> <tr> <td>FTU AE 97C</td> <td>150</td> <td>0,13</td> <td>G 1/4</td> </tr> </tbody> </table>	Typ	Förderstrom Q, l/h	Motorleistung kW	Anschlusmaße DN	FTU AE 47C	50	0,13	G 1/4	FTU AE 97C	150	0,13	G 1/4	601 620 601 621																																																																																					
Typ	Förderstrom Q, l/h	Motorleistung kW	Anschlusmaße DN																																																																																																
FTU AE 47C	50	0,13	G 1/4																																																																																																
FTU AE 97C	150	0,13	G 1/4																																																																																																
	Ersatzteile für FTU																																																																																																		
1.602	Pumpe AE V 47 C 1700 6 M/FTU AE 47 C Suntec. AE V 97 C 7304 2 M/FTU AE 97 C Suntec.	601 752 601 755																																																																																																	
1.603	Filtersatz AE 47 AE 97	601 107 601 102																																																																																																	
1.604	Motor mit Kupplung für FTU AE 97C 120 W 220V, 50 Hz	601 461																																																																																																	
1.605	Kupplung FTU AE	652 049																																																																																																	
	Ringleitungsarmaturen																																																																																																		
1.606	Einzel-Pumpenaggregat Baureihe KFT bestehend aus: Schraubenspindelpumpe, internes Sicherheitsventil, Motor Schutzart IP54, Manometer mit Absperrhahn, Anschweiß-Gegenflanschen Saug- und Druckseite, komplett auf Ölwanne aufgebaut																																																																																																		
	Für Heizöl EL, max. 4 bar, 50 Hz																																																																																																		
	<table border="1"> <thead> <tr> <th>Typ</th> <th>Fördermenge l/h</th> <th>Spannung V</th> <th>Motor- kW</th> <th>Drehzahl 1/min.</th> <th>Anschlußmaße Saugseite DN</th> <th>Druckseite DN</th> <th></th> </tr> </thead> <tbody> <tr><td>KFT-7</td><td>150</td><td>230/400</td><td>0,18</td><td>950</td><td>25</td><td>25</td><td>574 000 0501 0</td></tr> <tr><td>KFT-7</td><td>312</td><td>230/400</td><td>0,25</td><td>1450</td><td>25</td><td>25</td><td>574 000 0502 0</td></tr> <tr><td>KFT-15</td><td>378</td><td>230/400</td><td>0,18</td><td>950</td><td>25</td><td>25</td><td>574 000 0503 0</td></tr> <tr><td>KFT-5</td><td>510</td><td>230/400</td><td>0,37</td><td>2900</td><td>25</td><td>25</td><td>574 000 0504 0</td></tr> <tr><td>KFT-7</td><td>780</td><td>230/400</td><td>0,37</td><td>2900</td><td>25</td><td>25</td><td>574 000 0505 0</td></tr> <tr><td>KFT-10</td><td>1062</td><td>230/400</td><td>0,37</td><td>2900</td><td>25</td><td>25</td><td>574 000 0506 0</td></tr> <tr><td>KFT-15</td><td>1632</td><td>230/400</td><td>0,37</td><td>2900</td><td>25</td><td>25</td><td>574 000 0507 0</td></tr> <tr><td>KFT-20</td><td>2148</td><td>230/400</td><td>0,55</td><td>2900</td><td>25</td><td>25</td><td>574 000 0508 0</td></tr> <tr><td>KFT-32</td><td>3498</td><td>230/400</td><td>0,75</td><td>2900</td><td>32</td><td>32</td><td>574 000 0509 0</td></tr> <tr><td>KFT-42</td><td>4662</td><td>400/690</td><td>1,1</td><td>2900</td><td>32</td><td>32</td><td>574 000 0510 0</td></tr> <tr><td>KFT-55</td><td>6414</td><td>400/690</td><td>1,5</td><td>2900</td><td>50</td><td>50</td><td>574 000 0511 0</td></tr> </tbody> </table>	Typ	Fördermenge l/h	Spannung V	Motor- kW	Drehzahl 1/min.	Anschlußmaße Saugseite DN	Druckseite DN		KFT-7	150	230/400	0,18	950	25	25	574 000 0501 0	KFT-7	312	230/400	0,25	1450	25	25	574 000 0502 0	KFT-15	378	230/400	0,18	950	25	25	574 000 0503 0	KFT-5	510	230/400	0,37	2900	25	25	574 000 0504 0	KFT-7	780	230/400	0,37	2900	25	25	574 000 0505 0	KFT-10	1062	230/400	0,37	2900	25	25	574 000 0506 0	KFT-15	1632	230/400	0,37	2900	25	25	574 000 0507 0	KFT-20	2148	230/400	0,55	2900	25	25	574 000 0508 0	KFT-32	3498	230/400	0,75	2900	32	32	574 000 0509 0	KFT-42	4662	400/690	1,1	2900	32	32	574 000 0510 0	KFT-55	6414	400/690	1,5	2900	50	50	574 000 0511 0		
Typ	Fördermenge l/h	Spannung V	Motor- kW	Drehzahl 1/min.	Anschlußmaße Saugseite DN	Druckseite DN																																																																																													
KFT-7	150	230/400	0,18	950	25	25	574 000 0501 0																																																																																												
KFT-7	312	230/400	0,25	1450	25	25	574 000 0502 0																																																																																												
KFT-15	378	230/400	0,18	950	25	25	574 000 0503 0																																																																																												
KFT-5	510	230/400	0,37	2900	25	25	574 000 0504 0																																																																																												
KFT-7	780	230/400	0,37	2900	25	25	574 000 0505 0																																																																																												
KFT-10	1062	230/400	0,37	2900	25	25	574 000 0506 0																																																																																												
KFT-15	1632	230/400	0,37	2900	25	25	574 000 0507 0																																																																																												
KFT-20	2148	230/400	0,55	2900	25	25	574 000 0508 0																																																																																												
KFT-32	3498	230/400	0,75	2900	32	32	574 000 0509 0																																																																																												
KFT-42	4662	400/690	1,1	2900	32	32	574 000 0510 0																																																																																												
KFT-55	6414	400/690	1,5	2900	50	50	574 000 0511 0																																																																																												
	Für Heizöl S, max. 7 bar, 50 Hz, Heizung 100 Watt																																																																																																		
	<table border="1"> <thead> <tr> <th>Typ</th> <th>Fördermenge l/h</th> <th>Spannung V</th> <th>Motor- kW</th> <th>Drehzahl 1/min.</th> <th>Anschlußmaße Saugseite DN</th> <th>Druckseite DN</th> <th></th> </tr> </thead> <tbody> <tr><td>KFT-7</td><td>276</td><td>230/400</td><td>0,18</td><td>950</td><td>25</td><td>25</td><td>574 500 0501 0</td></tr> <tr><td>KFT-7</td><td>438</td><td>230/400</td><td>0,25</td><td>1450</td><td>25</td><td>25</td><td>574 500 0502 0</td></tr> <tr><td>KFT-15</td><td>564</td><td>230/400</td><td>0,25</td><td>950</td><td>25</td><td>25</td><td>574 500 0503 0</td></tr> <tr><td>KFT-5</td><td>606</td><td>230/400</td><td>0,37</td><td>2900</td><td>25</td><td>25</td><td>574 500 0504 0</td></tr> <tr><td>KFT-7</td><td>912</td><td>230/400</td><td>0,55</td><td>2900</td><td>25</td><td>25</td><td>574 500 0505 0</td></tr> <tr><td>KFT-10</td><td>1218</td><td>230/400</td><td>0,75</td><td>2900</td><td>25</td><td>25</td><td>574 500 0506 0</td></tr> <tr><td>KFT-15</td><td>1818</td><td>230/400</td><td>1,1</td><td>2900</td><td>25</td><td>25</td><td>574 500 0507 0</td></tr> <tr><td>KFT-20</td><td>2388</td><td>230/400</td><td>1,5</td><td>2900</td><td>25</td><td>25</td><td>574 500 0508 0</td></tr> <tr><td>KFT-32</td><td>3786</td><td>230/400</td><td>2,2</td><td>2900</td><td>32</td><td>32</td><td>574 500 0509 0</td></tr> <tr><td>KFT-42</td><td>5040</td><td>400/690</td><td>3</td><td>2900</td><td>32</td><td>32</td><td>574 500 0510 0</td></tr> <tr><td>KFT-55*</td><td>6900</td><td>400/690</td><td>3</td><td>2900</td><td>50</td><td>50</td><td>574 500 0511 0</td></tr> </tbody> </table>	Typ	Fördermenge l/h	Spannung V	Motor- kW	Drehzahl 1/min.	Anschlußmaße Saugseite DN	Druckseite DN		KFT-7	276	230/400	0,18	950	25	25	574 500 0501 0	KFT-7	438	230/400	0,25	1450	25	25	574 500 0502 0	KFT-15	564	230/400	0,25	950	25	25	574 500 0503 0	KFT-5	606	230/400	0,37	2900	25	25	574 500 0504 0	KFT-7	912	230/400	0,55	2900	25	25	574 500 0505 0	KFT-10	1218	230/400	0,75	2900	25	25	574 500 0506 0	KFT-15	1818	230/400	1,1	2900	25	25	574 500 0507 0	KFT-20	2388	230/400	1,5	2900	25	25	574 500 0508 0	KFT-32	3786	230/400	2,2	2900	32	32	574 500 0509 0	KFT-42	5040	400/690	3	2900	32	32	574 500 0510 0	KFT-55*	6900	400/690	3	2900	50	50	574 500 0511 0		
Typ	Fördermenge l/h	Spannung V	Motor- kW	Drehzahl 1/min.	Anschlußmaße Saugseite DN	Druckseite DN																																																																																													
KFT-7	276	230/400	0,18	950	25	25	574 500 0501 0																																																																																												
KFT-7	438	230/400	0,25	1450	25	25	574 500 0502 0																																																																																												
KFT-15	564	230/400	0,25	950	25	25	574 500 0503 0																																																																																												
KFT-5	606	230/400	0,37	2900	25	25	574 500 0504 0																																																																																												
KFT-7	912	230/400	0,55	2900	25	25	574 500 0505 0																																																																																												
KFT-10	1218	230/400	0,75	2900	25	25	574 500 0506 0																																																																																												
KFT-15	1818	230/400	1,1	2900	25	25	574 500 0507 0																																																																																												
KFT-20	2388	230/400	1,5	2900	25	25	574 500 0508 0																																																																																												
KFT-32	3786	230/400	2,2	2900	32	32	574 500 0509 0																																																																																												
KFT-42	5040	400/690	3	2900	32	32	574 500 0510 0																																																																																												
KFT-55*	6900	400/690	3	2900	50	50	574 500 0511 0																																																																																												
	* Heizung 220 Watt																																																																																																		

No.	Description
1.6	Ring main fittings Pump unit f. oil EL (w/o picture), motor 220V~, 2800 rpm, 1.20A protect. required
	Type Capacity Q, l/h Motor rating kW Connection dimensions DN
1.601	FTU AE 47C 50 0.13 G 1/4
	FTU AE 97C 150 0.13 G 1/4
	Spares for FTU
1.602	Pump AE 47 C 1393 1 M AE 97 C 7390 2 M
1.603	Filter set AE 47 AE 97
1.604	Motor with coupling for FTU AE 97 C 120W 220V, 50Hz
1.605	Coupling for FTU AE
	Ring main fittings
1.606	Single pump station type KFT consisting of: Spindle screw pump, internal safety valve, motor type of protection IP54, pressure gauge with shut off valve, welded counter flange suction and pressure side, fitted complete to oil oil sump
	For fuel oil EL, max. 4 bar, 50 Hz
	Type Flow rate l/h Voltage V Motor rating kW Speed rpm Connection dimensions suction s./pressure s. DN/DN
	KFT-7 150 230/400 0.18 950 25/25
	KFT-7 312 230/400 0.25 1450 25/25
	KFT-15 378 230/400 0.18 950 25/25
	KFT-5 510 230/400 0.37 2900 25/25
	KFT-7 780 230/400 0.37 2900 25/25
	KFT-10 1062 230/400 0.37 2900 25/25
	KFT-15 1632 230/400 0.37 2900 25/25
	KFT-20 2148 230/400 0.55 2900 25/25
	KFT-32 3498 230/400 0.75 2900 32/32
	KFT-42 4662 400/690 1.1 2900 32/32
	KFT-55 6414 400/690 1.5 2900 50/50
	For fuel oil S, max. 7 bar, 50 Hz, heating 100 Watt
	Type Flow rate l/h Voltage V Motor rating kW Speed rpm Connection dimensions suction s./pressure s. DN/DN
	KFT-7 276 230/400 0.18 950 25/25
	KFT-7 438 230/400 0.25 1450 25/25
	KFT-15 564 230/400 0.25 950 25/25
	KFT-5 606 230/400 0.37 2900 25/25
	KFT-7 912 230/400 0.55 2900 25/25
	KFT-10 1218 230/400 0.75 2900 25/25
	KFT-15 1818 230/400 1.1 2900 25/25
	KFT-20 2388 230/400 1.5 2900 25/25
	KFT-32 3786 230/400 2.2 2900 32/32
	KFT-42 5040 400/690 3 2900 32/32
	KFT-55* 6900 400/690 3 2900 50/50
	* Heating 220 Watt

No.	Dénomination
1.6	Accessoires pour boucles de transfert Groupe pompe pour FOD (sans photo), moteur 220V ~, 2800 min ⁻¹ , protection moteur 1,20A nécessaire
	Type Débit Q, l/h Puissance moteur Raccordement DN
1.601	FTU AE 47C 50 0,13 G 1/4
	FTU AE 97C 150 0,13 G 1/4
	Pièces détachées pour FTU
1.602	Pompe AE 47 C 1393 1 M AE 97 C 7390 2 M
1.603	Filtre AE 47 AE 97
1.604	Moteur avec accouplement pour FTU AE 97C 120W 220V, 50 Hz
1.605	Accouplement FTU AE
	Accessoires boucle de transfert
1.606	Groupe pompe simple série KFT comprenant : Pompe à vis, vanne de sécurité interne, indice de protection moteur IP54, manomètre avec robinet d'isolement, contre-bridés à souder sur l'aspiration et le refoulement, complet pour montage sur cuve fioul
	Pour FOD, max. 4 bar, 50 Hz
	Type Débit l/h Tension V Moteur kW Vitesse de rotation 1/min. Raccordements aspir./refoul. DN/DN
	KFT-7 150 230/400 0,18 950 25/25
	KFT-7 312 230/400 0,25 1450 25/25
	KFT-15 378 230/400 0,18 950 25/25
	KFT-5 510 230/400 0,37 2900 25/25
	KFT-7 780 230/400 0,37 2900 25/25
	KFT-10 1062 230/400 0,37 2900 25/25
	KFT-15 1632 230/400 0,37 2900 25/25
	KFT-20 2148 230/400 0,55 2900 25/25
	KFT-32 3498 230/400 0,75 2900 32/32
	KFT-42 4662 400/690 1,1 2900 32/32
	KFT-55 6414 400/690 1,5 2900 50/50
	Pour FOL, max. 7 bar, 50 Hz, Heizung 100 Watt
	Type Débit- l/h Tension V Moteur kW Vitesse de rotation 1/min. Raccordements aspir./refoul. DN/DN
	KFT-7 276 230/400 0,18 950 25/25
	KFT-7 438 230/400 0,25 1450 25/25
	KFT-15 564 230/400 0,25 950 25/25
	KFT-5 606 230/400 0,37 2900 25/25
	KFT-7 912 230/400 0,55 2900 25/25
	KFT-10 1218 230/400 0,75 2900 25/25
	KFT-15 1818 230/400 1,1 2900 25/25
	KFT-20 2388 230/400 1,5 2900 25/25
	KFT-32 3786 230/400 2,2 2900 32/32
	KFT-42 5040 400/690 3 2900 32/32
	KFT-55* 6900 400/690 3 2900 50/50
	* Chauffage 220 Watt

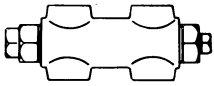

1.612

Nr.	Bezeichnung	Bestell-Nr. Order No. N° de commande	Preis EUR (o. MwSt.)																																																																																																																																																																																																
1.607	<p>Doppel-Pumpenaggregat Baureihe DKC bestehend aus: 2 Schraubenspindelpumpen, interne Sicherheitsventile, Motore Schutzart IP54, 3-Wege-Umschalthahn, Mano-Vakuummeter mit Absperrhahn, Schmutzfänger Maschenweite 0,25 mm bei Heizöl EL und 0,5 mm bei Heizöl S, Anschweiß-Gegenflanschen Saug- und Druckseite, komplett auf Ölwanne aufgebaut</p> <p>Für Heizöl EL, max. 4 bar, 50 Hz</p> <table border="1"> <thead> <tr> <th>Typ</th> <th>Fördermenge l/h</th> <th>Spannung V</th> <th>Motor-kW</th> <th>Drehzahl 1/min.</th> <th>Anschlußmaße Saugseite DN</th> <th>Druckseite DN</th> <th></th> </tr> </thead> <tbody> <tr><td>DKC-200</td><td>150</td><td>230/400</td><td>0,18</td><td>950</td><td>SAE 1 1/2"</td><td>SAE 1 1/2"</td><td>574 000 0523 0</td></tr> <tr><td>DKC-450</td><td>312</td><td>230/400</td><td>0,25</td><td>1450</td><td>SAE 1 1/2"</td><td>SAE 1 1/2"</td><td>574 000 0524 0</td></tr> <tr><td>DKC-420</td><td>378</td><td>230/400</td><td>0,18</td><td>950</td><td>SAE 1 1/2"</td><td>SAE 1 1/2"</td><td>574 000 0525 0</td></tr> <tr><td>DKC-600</td><td>510</td><td>230/400</td><td>0,37</td><td>2900</td><td>SAE 1 1/2"</td><td>SAE 1 1/2"</td><td>574 000 0526 0</td></tr> <tr><td>DKC-900</td><td>780</td><td>230/400</td><td>0,37</td><td>2900</td><td>SAE 1 1/2"</td><td>SAE 1 1/2"</td><td>574 000 0527 0</td></tr> <tr><td>DKC-1200</td><td>1062</td><td>230/400</td><td>0,37</td><td>2900</td><td>SAE 1 1/2"</td><td>SAE 1 1/2"</td><td>574 000 0528 0</td></tr> <tr><td>DKC-1800</td><td>1632</td><td>230/400</td><td>0,37</td><td>2900</td><td>SAE 1 1/2"</td><td>SAE 1 1/2"</td><td>574 000 0529 0</td></tr> <tr><td>DKC-2400</td><td>2148</td><td>230/400</td><td>0,55</td><td>2900</td><td>SAE 1 1/2"</td><td>SAE 1 1/2"</td><td>574 000 0530 0</td></tr> <tr><td>DKC-3300</td><td>3498</td><td>230/400</td><td>0,75</td><td>2900</td><td>SAE 1 1/2"</td><td>SAE 1 1/2"</td><td>574 000 0531 0</td></tr> <tr><td>DKC-5000</td><td>4662</td><td>400/690</td><td>1,1</td><td>2900</td><td>SAE 1 1/2"</td><td>SAE 1 1/2"</td><td>574 000 0532 0</td></tr> <tr><td>DKC-6000</td><td>6414</td><td>400/690</td><td>1,5</td><td>2900</td><td>SAE 2"</td><td>SAE 2"</td><td>574 000 0533 0</td></tr> </tbody> </table> <p>Für Heizöl S, max. 7 bar, 50 Hz, Heizung 220 Watt</p> <table border="1"> <thead> <tr> <th>Typ</th> <th>Fördermenge l/h</th> <th>Spannung V</th> <th>Motor-kW</th> <th>Drehzahl 1/min.</th> <th>Anschlußmaße Saugseite DN</th> <th>Druckseite DN</th> <th></th> </tr> </thead> <tbody> <tr><td>DKC-200</td><td>276</td><td>230/400</td><td>0,18</td><td>950</td><td>SAE 1 1/2"</td><td>SAE 1 1/2"</td><td>574 500 0523 0</td></tr> <tr><td>DKC-450</td><td>438</td><td>230/400</td><td>0,25</td><td>1450</td><td>SAE 1 1/2"</td><td>SAE 1 1/2"</td><td>574 500 0524 0</td></tr> <tr><td>DKC-420</td><td>564</td><td>230/400</td><td>0,25</td><td>950</td><td>SAE 1 1/2"</td><td>SAE 1 1/2"</td><td>574 500 0525 0</td></tr> <tr><td>DKC-600</td><td>606</td><td>230/400</td><td>0,37</td><td>2900</td><td>SAE 1 1/2"</td><td>SAE 1 1/2"</td><td>574 500 0526 0</td></tr> <tr><td>DKC-900</td><td>912</td><td>230/400</td><td>0,55</td><td>2900</td><td>SAE 1 1/2"</td><td>SAE 1 1/2"</td><td>574 500 0527 0</td></tr> <tr><td>DKC-1200</td><td>1218</td><td>230/400</td><td>0,75</td><td>2900</td><td>SAE 1 1/2"</td><td>SAE 1 1/2"</td><td>574 500 0528 0</td></tr> <tr><td>DKC-1800</td><td>1818</td><td>230/400</td><td>1,1</td><td>2900</td><td>SAE 1 1/2"</td><td>SAE 1 1/2"</td><td>574 500 0529 0</td></tr> <tr><td>DKC-2400</td><td>2388</td><td>230/400</td><td>1,5</td><td>2900</td><td>SAE 1 1/2"</td><td>SAE 1 1/2"</td><td>574 500 0530 0</td></tr> <tr><td>DKC-3300</td><td>3786</td><td>230/400</td><td>2,2</td><td>2900</td><td>SAE 1 1/2"</td><td>SAE 1 1/2"</td><td>574 500 0531 0</td></tr> <tr><td>DKC-5000</td><td>5040</td><td>400/690</td><td>3</td><td>2900</td><td>SAE 1 1/2"</td><td>SAE 1 1/2"</td><td>574 500 0532 0</td></tr> <tr><td>DKC-6000*</td><td>6900</td><td>400/690</td><td>3</td><td>2900</td><td>SAE 2"</td><td>SAE 2"</td><td>574 500 0533 0</td></tr> </tbody> </table> <p>* Heizung 440 Watt</p>	Typ	Fördermenge l/h	Spannung V	Motor-kW	Drehzahl 1/min.	Anschlußmaße Saugseite DN	Druckseite DN		DKC-200	150	230/400	0,18	950	SAE 1 1/2"	SAE 1 1/2"	574 000 0523 0	DKC-450	312	230/400	0,25	1450	SAE 1 1/2"	SAE 1 1/2"	574 000 0524 0	DKC-420	378	230/400	0,18	950	SAE 1 1/2"	SAE 1 1/2"	574 000 0525 0	DKC-600	510	230/400	0,37	2900	SAE 1 1/2"	SAE 1 1/2"	574 000 0526 0	DKC-900	780	230/400	0,37	2900	SAE 1 1/2"	SAE 1 1/2"	574 000 0527 0	DKC-1200	1062	230/400	0,37	2900	SAE 1 1/2"	SAE 1 1/2"	574 000 0528 0	DKC-1800	1632	230/400	0,37	2900	SAE 1 1/2"	SAE 1 1/2"	574 000 0529 0	DKC-2400	2148	230/400	0,55	2900	SAE 1 1/2"	SAE 1 1/2"	574 000 0530 0	DKC-3300	3498	230/400	0,75	2900	SAE 1 1/2"	SAE 1 1/2"	574 000 0531 0	DKC-5000	4662	400/690	1,1	2900	SAE 1 1/2"	SAE 1 1/2"	574 000 0532 0	DKC-6000	6414	400/690	1,5	2900	SAE 2"	SAE 2"	574 000 0533 0	Typ	Fördermenge l/h	Spannung V	Motor-kW	Drehzahl 1/min.	Anschlußmaße Saugseite DN	Druckseite DN		DKC-200	276	230/400	0,18	950	SAE 1 1/2"	SAE 1 1/2"	574 500 0523 0	DKC-450	438	230/400	0,25	1450	SAE 1 1/2"	SAE 1 1/2"	574 500 0524 0	DKC-420	564	230/400	0,25	950	SAE 1 1/2"	SAE 1 1/2"	574 500 0525 0	DKC-600	606	230/400	0,37	2900	SAE 1 1/2"	SAE 1 1/2"	574 500 0526 0	DKC-900	912	230/400	0,55	2900	SAE 1 1/2"	SAE 1 1/2"	574 500 0527 0	DKC-1200	1218	230/400	0,75	2900	SAE 1 1/2"	SAE 1 1/2"	574 500 0528 0	DKC-1800	1818	230/400	1,1	2900	SAE 1 1/2"	SAE 1 1/2"	574 500 0529 0	DKC-2400	2388	230/400	1,5	2900	SAE 1 1/2"	SAE 1 1/2"	574 500 0530 0	DKC-3300	3786	230/400	2,2	2900	SAE 1 1/2"	SAE 1 1/2"	574 500 0531 0	DKC-5000	5040	400/690	3	2900	SAE 1 1/2"	SAE 1 1/2"	574 500 0532 0	DKC-6000*	6900	400/690	3	2900	SAE 2"	SAE 2"	574 500 0533 0		
Typ	Fördermenge l/h	Spannung V	Motor-kW	Drehzahl 1/min.	Anschlußmaße Saugseite DN	Druckseite DN																																																																																																																																																																																													
DKC-200	150	230/400	0,18	950	SAE 1 1/2"	SAE 1 1/2"	574 000 0523 0																																																																																																																																																																																												
DKC-450	312	230/400	0,25	1450	SAE 1 1/2"	SAE 1 1/2"	574 000 0524 0																																																																																																																																																																																												
DKC-420	378	230/400	0,18	950	SAE 1 1/2"	SAE 1 1/2"	574 000 0525 0																																																																																																																																																																																												
DKC-600	510	230/400	0,37	2900	SAE 1 1/2"	SAE 1 1/2"	574 000 0526 0																																																																																																																																																																																												
DKC-900	780	230/400	0,37	2900	SAE 1 1/2"	SAE 1 1/2"	574 000 0527 0																																																																																																																																																																																												
DKC-1200	1062	230/400	0,37	2900	SAE 1 1/2"	SAE 1 1/2"	574 000 0528 0																																																																																																																																																																																												
DKC-1800	1632	230/400	0,37	2900	SAE 1 1/2"	SAE 1 1/2"	574 000 0529 0																																																																																																																																																																																												
DKC-2400	2148	230/400	0,55	2900	SAE 1 1/2"	SAE 1 1/2"	574 000 0530 0																																																																																																																																																																																												
DKC-3300	3498	230/400	0,75	2900	SAE 1 1/2"	SAE 1 1/2"	574 000 0531 0																																																																																																																																																																																												
DKC-5000	4662	400/690	1,1	2900	SAE 1 1/2"	SAE 1 1/2"	574 000 0532 0																																																																																																																																																																																												
DKC-6000	6414	400/690	1,5	2900	SAE 2"	SAE 2"	574 000 0533 0																																																																																																																																																																																												
Typ	Fördermenge l/h	Spannung V	Motor-kW	Drehzahl 1/min.	Anschlußmaße Saugseite DN	Druckseite DN																																																																																																																																																																																													
DKC-200	276	230/400	0,18	950	SAE 1 1/2"	SAE 1 1/2"	574 500 0523 0																																																																																																																																																																																												
DKC-450	438	230/400	0,25	1450	SAE 1 1/2"	SAE 1 1/2"	574 500 0524 0																																																																																																																																																																																												
DKC-420	564	230/400	0,25	950	SAE 1 1/2"	SAE 1 1/2"	574 500 0525 0																																																																																																																																																																																												
DKC-600	606	230/400	0,37	2900	SAE 1 1/2"	SAE 1 1/2"	574 500 0526 0																																																																																																																																																																																												
DKC-900	912	230/400	0,55	2900	SAE 1 1/2"	SAE 1 1/2"	574 500 0527 0																																																																																																																																																																																												
DKC-1200	1218	230/400	0,75	2900	SAE 1 1/2"	SAE 1 1/2"	574 500 0528 0																																																																																																																																																																																												
DKC-1800	1818	230/400	1,1	2900	SAE 1 1/2"	SAE 1 1/2"	574 500 0529 0																																																																																																																																																																																												
DKC-2400	2388	230/400	1,5	2900	SAE 1 1/2"	SAE 1 1/2"	574 500 0530 0																																																																																																																																																																																												
DKC-3300	3786	230/400	2,2	2900	SAE 1 1/2"	SAE 1 1/2"	574 500 0531 0																																																																																																																																																																																												
DKC-5000	5040	400/690	3	2900	SAE 1 1/2"	SAE 1 1/2"	574 500 0532 0																																																																																																																																																																																												
DKC-6000*	6900	400/690	3	2900	SAE 2"	SAE 2"	574 500 0533 0																																																																																																																																																																																												
1.612	<p>Druckregelventil, Druckstufe 2 zur Konstanthaltung des Druckes in Ölleitungen Folgender Druckbereich ist viskositätsabhängig einstellbar</p> <p>EL-Öl, Viskosität 5 cSt. 1 - 6 bar S-Öl, Viskosität 152 cSt. 2 - 6 bar S-Öl, Viskosität 380 cSt. 2,8 - 6 bar</p> <table border="1"> <thead> <tr> <th>Typ</th> <th colspan="2">Durchflussmenge l/h</th> <th>Anschluß</th> <th></th> </tr> <tr> <td></td> <th>EL min. - max.</th> <th>S min. - max.</th> <td></td> <td></td> </tr> </thead> <tbody> <tr><td>B-PP</td><td>15 - 120</td><td>15 - 120</td><td>G 1/4</td><td>605 067</td></tr> <tr><td>B-P</td><td>24 - 300</td><td>24 - 270</td><td>G 3/8</td><td>605 068</td></tr> <tr><td>B-G</td><td>90 - 600</td><td>90 - 580</td><td>G 1/2</td><td>605 069</td></tr> <tr><td>B-GH-E/2</td><td>300 - 2000</td><td>300 - 1700</td><td>G 3/4</td><td>605 070</td></tr> <tr><td>B-GHG</td><td>900 - 5800</td><td>900 - 4800</td><td>G 1</td><td>605 071</td></tr> <tr><td>B-GHG</td><td>1500 - 8800</td><td>1500 - 8800</td><td>G 1 1/4</td><td>605 072</td></tr> </tbody> </table>	Typ	Durchflussmenge l/h		Anschluß			EL min. - max.	S min. - max.			B-PP	15 - 120	15 - 120	G 1/4	605 067	B-P	24 - 300	24 - 270	G 3/8	605 068	B-G	90 - 600	90 - 580	G 1/2	605 069	B-GH-E/2	300 - 2000	300 - 1700	G 3/4	605 070	B-GHG	900 - 5800	900 - 4800	G 1	605 071	B-GHG	1500 - 8800	1500 - 8800	G 1 1/4	605 072																																																																																																																																																										
Typ	Durchflussmenge l/h		Anschluß																																																																																																																																																																																																
	EL min. - max.	S min. - max.																																																																																																																																																																																																	
B-PP	15 - 120	15 - 120	G 1/4	605 067																																																																																																																																																																																															
B-P	24 - 300	24 - 270	G 3/8	605 068																																																																																																																																																																																															
B-G	90 - 600	90 - 580	G 1/2	605 069																																																																																																																																																																																															
B-GH-E/2	300 - 2000	300 - 1700	G 3/4	605 070																																																																																																																																																																																															
B-GHG	900 - 5800	900 - 4800	G 1	605 071																																																																																																																																																																																															
B-GHG	1500 - 8800	1500 - 8800	G 1 1/4	605 072																																																																																																																																																																																															

No.	Description																																																																																																																																																
1.607	<p>Double pump station type DKC consisting of: 2 spindle screw pumps, internal safety valves, motors type of protection IP54, 3 way change-over valve, vacuum gauge with shut off valve, strainer mesh aperture 0.25 mm for fuel oil EL and 0.5 mm for fuel oil S welded counter flange suction and pressure side, fitted complete to oil sump</p> <p>For fuel oil EL, max. 4 bar, 50 Hz</p> <table border="1"> <thead> <tr> <th>Type</th> <th>Flow rate l/h</th> <th>Voltage V</th> <th>Motor rating kW</th> <th>Speed rpm</th> <th>Connection dimensions suction s./pressure s. DN/DN</th> </tr> </thead> <tbody> <tr><td>DKC-200</td><td>150</td><td>230/400</td><td>0.18</td><td>950</td><td>SAE 1 1/2"/SAE 1 1/2"</td></tr> <tr><td>DKC-450</td><td>312</td><td>230/400</td><td>0.25</td><td>1450</td><td>SAE 1 1/2"/SAE 1 1/2"</td></tr> <tr><td>DKC-420</td><td>378</td><td>230/400</td><td>0.18</td><td>950</td><td>SAE 1 1/2"/SAE 1 1/2"</td></tr> <tr><td>DKC-600</td><td>510</td><td>230/400</td><td>0.37</td><td>2900</td><td>SAE 1 1/2"/SAE 1 1/2"</td></tr> <tr><td>DKC-900</td><td>780</td><td>230/400</td><td>0.37</td><td>2900</td><td>SAE 1 1/2"/SAE 1 1/2"</td></tr> <tr><td>DKC-1200</td><td>1062</td><td>230/400</td><td>0.37</td><td>2900</td><td>SAE 1 1/2"/SAE 1 1/2"</td></tr> <tr><td>DKC-1800</td><td>1632</td><td>230/400</td><td>0.37</td><td>2900</td><td>SAE 1 1/2"/SAE 1 1/2"</td></tr> <tr><td>DKC-2400</td><td>2148</td><td>230/400</td><td>0.55</td><td>2900</td><td>SAE 1 1/2"/SAE 1 1/2"</td></tr> <tr><td>DKC-3300</td><td>3498</td><td>230/400</td><td>0.75</td><td>2900</td><td>SAE 1 1/2"/SAE 1 1/2"</td></tr> <tr><td>DKC-5000</td><td>4662</td><td>400/690</td><td>1.1</td><td>2900</td><td>SAE 1 1/2"/SAE 1 1/2"</td></tr> <tr><td>DKC-6000</td><td>6414</td><td>400/690</td><td>1.5</td><td>2900</td><td>SAE 2"/SAE 2"</td></tr> </tbody> </table> <p>For fuel oil S, max. 7 bar, 50 Hz, heating 220 Watt</p> <table border="1"> <thead> <tr> <th>Type</th> <th>Flow rate l/h</th> <th>Voltage V</th> <th>Motor rating kW</th> <th>Speed rpm</th> <th>Connection dimensions suction s./pressure s. DN/DN</th> </tr> </thead> <tbody> <tr><td>DKC-200</td><td>276</td><td>230/400</td><td>0.18</td><td>950</td><td>SAE 1 1/2"/SAE 1 1/2"</td></tr> <tr><td>DKC-450</td><td>438</td><td>230/400</td><td>0.25</td><td>1450</td><td>SAE 1 1/2"/SAE 1 1/2"</td></tr> <tr><td>DKC-420</td><td>564</td><td>230/400</td><td>0.25</td><td>950</td><td>SAE 1 1/2"/SAE 1 1/2"</td></tr> <tr><td>DKC-600</td><td>606</td><td>230/400</td><td>0.37</td><td>2900</td><td>SAE 1 1/2"/SAE 1 1/2"</td></tr> <tr><td>DKC-900</td><td>912</td><td>230/400</td><td>0.55</td><td>2900</td><td>SAE 1 1/2"/SAE 1 1/2"</td></tr> <tr><td>DKC-1200</td><td>1218</td><td>230/400</td><td>0.75</td><td>2900</td><td>SAE 1 1/2"/SAE 1 1/2"</td></tr> <tr><td>DKC-1800</td><td>1818</td><td>230/400</td><td>1.1</td><td>2900</td><td>SAE 1 1/2"/SAE 1 1/2"</td></tr> <tr><td>DKC-2400</td><td>2388</td><td>230/400</td><td>1.5</td><td>2900</td><td>SAE 1 1/2"/SAE 1 1/2"</td></tr> <tr><td>DKC-3300</td><td>3786</td><td>230/400</td><td>2.2</td><td>2900</td><td>SAE 1 1/2"/SAE 1 1/2"</td></tr> <tr><td>DKC-5000</td><td>5040</td><td>400/690</td><td>3</td><td>2900</td><td>SAE 1 1/2"/SAE 1 1/2"</td></tr> <tr><td>DKC-6000</td><td>6900</td><td>400/690</td><td>3</td><td>2900</td><td>SAE 2"/SAE 2"</td></tr> </tbody> </table>	Type	Flow rate l/h	Voltage V	Motor rating kW	Speed rpm	Connection dimensions suction s./pressure s. DN/DN	DKC-200	150	230/400	0.18	950	SAE 1 1/2"/SAE 1 1/2"	DKC-450	312	230/400	0.25	1450	SAE 1 1/2"/SAE 1 1/2"	DKC-420	378	230/400	0.18	950	SAE 1 1/2"/SAE 1 1/2"	DKC-600	510	230/400	0.37	2900	SAE 1 1/2"/SAE 1 1/2"	DKC-900	780	230/400	0.37	2900	SAE 1 1/2"/SAE 1 1/2"	DKC-1200	1062	230/400	0.37	2900	SAE 1 1/2"/SAE 1 1/2"	DKC-1800	1632	230/400	0.37	2900	SAE 1 1/2"/SAE 1 1/2"	DKC-2400	2148	230/400	0.55	2900	SAE 1 1/2"/SAE 1 1/2"	DKC-3300	3498	230/400	0.75	2900	SAE 1 1/2"/SAE 1 1/2"	DKC-5000	4662	400/690	1.1	2900	SAE 1 1/2"/SAE 1 1/2"	DKC-6000	6414	400/690	1.5	2900	SAE 2"/SAE 2"	Type	Flow rate l/h	Voltage V	Motor rating kW	Speed rpm	Connection dimensions suction s./pressure s. DN/DN	DKC-200	276	230/400	0.18	950	SAE 1 1/2"/SAE 1 1/2"	DKC-450	438	230/400	0.25	1450	SAE 1 1/2"/SAE 1 1/2"	DKC-420	564	230/400	0.25	950	SAE 1 1/2"/SAE 1 1/2"	DKC-600	606	230/400	0.37	2900	SAE 1 1/2"/SAE 1 1/2"	DKC-900	912	230/400	0.55	2900	SAE 1 1/2"/SAE 1 1/2"	DKC-1200	1218	230/400	0.75	2900	SAE 1 1/2"/SAE 1 1/2"	DKC-1800	1818	230/400	1.1	2900	SAE 1 1/2"/SAE 1 1/2"	DKC-2400	2388	230/400	1.5	2900	SAE 1 1/2"/SAE 1 1/2"	DKC-3300	3786	230/400	2.2	2900	SAE 1 1/2"/SAE 1 1/2"	DKC-5000	5040	400/690	3	2900	SAE 1 1/2"/SAE 1 1/2"	DKC-6000	6900	400/690	3	2900	SAE 2"/SAE 2"
Type	Flow rate l/h	Voltage V	Motor rating kW	Speed rpm	Connection dimensions suction s./pressure s. DN/DN																																																																																																																																												
DKC-200	150	230/400	0.18	950	SAE 1 1/2"/SAE 1 1/2"																																																																																																																																												
DKC-450	312	230/400	0.25	1450	SAE 1 1/2"/SAE 1 1/2"																																																																																																																																												
DKC-420	378	230/400	0.18	950	SAE 1 1/2"/SAE 1 1/2"																																																																																																																																												
DKC-600	510	230/400	0.37	2900	SAE 1 1/2"/SAE 1 1/2"																																																																																																																																												
DKC-900	780	230/400	0.37	2900	SAE 1 1/2"/SAE 1 1/2"																																																																																																																																												
DKC-1200	1062	230/400	0.37	2900	SAE 1 1/2"/SAE 1 1/2"																																																																																																																																												
DKC-1800	1632	230/400	0.37	2900	SAE 1 1/2"/SAE 1 1/2"																																																																																																																																												
DKC-2400	2148	230/400	0.55	2900	SAE 1 1/2"/SAE 1 1/2"																																																																																																																																												
DKC-3300	3498	230/400	0.75	2900	SAE 1 1/2"/SAE 1 1/2"																																																																																																																																												
DKC-5000	4662	400/690	1.1	2900	SAE 1 1/2"/SAE 1 1/2"																																																																																																																																												
DKC-6000	6414	400/690	1.5	2900	SAE 2"/SAE 2"																																																																																																																																												
Type	Flow rate l/h	Voltage V	Motor rating kW	Speed rpm	Connection dimensions suction s./pressure s. DN/DN																																																																																																																																												
DKC-200	276	230/400	0.18	950	SAE 1 1/2"/SAE 1 1/2"																																																																																																																																												
DKC-450	438	230/400	0.25	1450	SAE 1 1/2"/SAE 1 1/2"																																																																																																																																												
DKC-420	564	230/400	0.25	950	SAE 1 1/2"/SAE 1 1/2"																																																																																																																																												
DKC-600	606	230/400	0.37	2900	SAE 1 1/2"/SAE 1 1/2"																																																																																																																																												
DKC-900	912	230/400	0.55	2900	SAE 1 1/2"/SAE 1 1/2"																																																																																																																																												
DKC-1200	1218	230/400	0.75	2900	SAE 1 1/2"/SAE 1 1/2"																																																																																																																																												
DKC-1800	1818	230/400	1.1	2900	SAE 1 1/2"/SAE 1 1/2"																																																																																																																																												
DKC-2400	2388	230/400	1.5	2900	SAE 1 1/2"/SAE 1 1/2"																																																																																																																																												
DKC-3300	3786	230/400	2.2	2900	SAE 1 1/2"/SAE 1 1/2"																																																																																																																																												
DKC-5000	5040	400/690	3	2900	SAE 1 1/2"/SAE 1 1/2"																																																																																																																																												
DKC-6000	6900	400/690	3	2900	SAE 2"/SAE 2"																																																																																																																																												
1.612	<p>Pressure regulating valve, pressure stage 2 to keep the pressure in the oil lines stable pressure range: (in reference to the max. quantity of flow)</p> <p>Light oil "EL", viscosity 5 cSt. 1 - 6 bar Heavy oil "S", viscosity 152 cSt. 2 - 6 bar Heavy oil "S", viscosity 380 cSt. 2.8 - 6 bar</p> <table border="1"> <thead> <tr> <th>Type</th> <th colspan="2">Quantity of flow l/h</th> <th>Connection</th> </tr> <tr> <td></td> <th>EL min. - max.</th> <th>S min. - max.</th> <td></td> </tr> </thead> <tbody> <tr><td>B-PP</td><td>15 - 120</td><td>15 - 120</td><td>G 1/4</td></tr> <tr><td>B-P</td><td>24 - 300</td><td>24 - 270</td><td>G 3/8</td></tr> <tr><td>B-G</td><td>90 - 600</td><td>90 - 580</td><td>G 1/2</td></tr> <tr><td>B-GH-E/2</td><td>300 - 2000</td><td>300 - 1700</td><td>G 3/4</td></tr> <tr><td>B-GHG</td><td>900 - 5800</td><td>900 - 4800</td><td>G 1</td></tr> <tr><td>B-GHG</td><td>1500 - 8800</td><td>1500 - 8800</td><td>G 1 1/4</td></tr> </tbody> </table>	Type	Quantity of flow l/h		Connection		EL min. - max.	S min. - max.		B-PP	15 - 120	15 - 120	G 1/4	B-P	24 - 300	24 - 270	G 3/8	B-G	90 - 600	90 - 580	G 1/2	B-GH-E/2	300 - 2000	300 - 1700	G 3/4	B-GHG	900 - 5800	900 - 4800	G 1	B-GHG	1500 - 8800	1500 - 8800	G 1 1/4																																																																																																																
Type	Quantity of flow l/h		Connection																																																																																																																																														
	EL min. - max.	S min. - max.																																																																																																																																															
B-PP	15 - 120	15 - 120	G 1/4																																																																																																																																														
B-P	24 - 300	24 - 270	G 3/8																																																																																																																																														
B-G	90 - 600	90 - 580	G 1/2																																																																																																																																														
B-GH-E/2	300 - 2000	300 - 1700	G 3/4																																																																																																																																														
B-GHG	900 - 5800	900 - 4800	G 1																																																																																																																																														
B-GHG	1500 - 8800	1500 - 8800	G 1 1/4																																																																																																																																														

No.	Dénomination																																																																																																																																																
1.607	<p>Groupe pompe double série DKC comprenant : 2 pompes à vis, vannes de sécurité internes, indice de protection moteur IP54, vanne 3 voies, Mano/vacuomètre avec robinet d'isolement, filtre écartement de mailles 0,25 mm en FOD et 0,5 mm en FOL, contre-brides à souder sur l'aspiration et le refoulement, complet pour montage sur cuve fioul</p> <p>Pour FOD, max. 4 bar, 50 Hz</p> <table border="1"> <thead> <tr> <th>Type</th> <th>Débit l/h</th> <th>Tension V</th> <th>Moteur kW</th> <th>Vitesse de rotation 1/min.</th> <th>Raccordements aspir./refoul. DN/DN</th> </tr> </thead> <tbody> <tr><td>DKC-200</td><td>150</td><td>230/400</td><td>0,18</td><td>950</td><td>SAE 1 1/2"/SAE 1 1/2"</td></tr> <tr><td>DKC-450</td><td>312</td><td>230/400</td><td>0,25</td><td>1450</td><td>SAE 1 1/2"/SAE 1 1/2"</td></tr> <tr><td>DKC-420</td><td>378</td><td>230/400</td><td>0,18</td><td>950</td><td>SAE 1 1/2"/SAE 1 1/2"</td></tr> <tr><td>DKC-600</td><td>510</td><td>230/400</td><td>0,37</td><td>2900</td><td>SAE 1 1/2"/SAE 1 1/2"</td></tr> <tr><td>DKC-900</td><td>780</td><td>230/400</td><td>0,37</td><td>2900</td><td>SAE 1 1/2"/SAE 1 1/2"</td></tr> <tr><td>DKC-1200</td><td>1062</td><td>230/400</td><td>0,37</td><td>2900</td><td>SAE 1 1/2"/SAE 1 1/2"</td></tr> <tr><td>DKC-1800</td><td>1632</td><td>230/400</td><td>0,37</td><td>2900</td><td>SAE 1 1/2"/SAE 1 1/2"</td></tr> <tr><td>DKC-2400</td><td>2148</td><td>230/400</td><td>0,55</td><td>2900</td><td>SAE 1 1/2"/SAE 1 1/2"</td></tr> <tr><td>DKC-3300</td><td>3498</td><td>230/400</td><td>0,75</td><td>2900</td><td>SAE 1 1/2"/SAE 1 1/2"</td></tr> <tr><td>DKC-5000</td><td>4662</td><td>400/690</td><td>1,1</td><td>2900</td><td>SAE 1 1/2"/SAE 1 1/2"</td></tr> <tr><td>DKC-6000</td><td>6414</td><td>400/690</td><td>1,5</td><td>2900</td><td>SAE 2"/SAE 2"</td></tr> </tbody> </table> <p>Pour FOL, max. 7 bar, 50 Hz, Heizung 220 Watt</p> <table border="1"> <thead> <tr> <th>Type</th> <th>Débit l/h</th> <th>Tension V</th> <th>Moteur kW</th> <th>Vitesse de rotation 1/min.</th> <th>Raccordements aspir./refoul. DN/DN</th> </tr> </thead> <tbody> <tr><td>DKC-200</td><td>276</td><td>230/400</td><td>0,18</td><td>950</td><td>SAE 1 1/2"/SAE 1 1/2"</td></tr> <tr><td>DKC-450</td><td>438</td><td>230/400</td><td>0,25</td><td>1450</td><td>SAE 1 1/2"/SAE 1 1/2"</td></tr> <tr><td>DKC-420</td><td>564</td><td>230/400</td><td>0,25</td><td>950</td><td>SAE 1 1/2"/SAE 1 1/2"</td></tr> <tr><td>DKC-600</td><td>606</td><td>230/400</td><td>0,37</td><td>2900</td><td>SAE 1 1/2"/SAE 1 1/2"</td></tr> <tr><td>DKC-900</td><td>912</td><td>230/400</td><td>0,55</td><td>2900</td><td>SAE 1 1/2"/SAE 1 1/2"</td></tr> <tr><td>DKC-1200</td><td>1218</td><td>230/400</td><td>0,75</td><td>2900</td><td>SAE 1 1/2"/SAE 1 1/2"</td></tr> <tr><td>DKC-1800</td><td>1818</td><td>230/400</td><td>1,1</td><td>2900</td><td>SAE 1 1/2"/SAE 1 1/2"</td></tr> <tr><td>DKC-2400</td><td>2388</td><td>230/400</td><td>1,5</td><td>2900</td><td>SAE 1 1/2"/SAE 1 1/2"</td></tr> <tr><td>DKC-3300</td><td>3786</td><td>230/400</td><td>2,2</td><td>2900</td><td>SAE 1 1/2"/SAE 1 1/2"</td></tr> <tr><td>DKC-5000</td><td>5040</td><td>400/690</td><td>3</td><td>2900</td><td>SAE 1 1/2"/SAE 1 1/2"</td></tr> <tr><td>DKC-6000</td><td>6900</td><td>400/690</td><td>3</td><td>2900</td><td>SAE 2"/SAE 2"</td></tr> </tbody> </table>	Type	Débit l/h	Tension V	Moteur kW	Vitesse de rotation 1/min.	Raccordements aspir./refoul. DN/DN	DKC-200	150	230/400	0,18	950	SAE 1 1/2"/SAE 1 1/2"	DKC-450	312	230/400	0,25	1450	SAE 1 1/2"/SAE 1 1/2"	DKC-420	378	230/400	0,18	950	SAE 1 1/2"/SAE 1 1/2"	DKC-600	510	230/400	0,37	2900	SAE 1 1/2"/SAE 1 1/2"	DKC-900	780	230/400	0,37	2900	SAE 1 1/2"/SAE 1 1/2"	DKC-1200	1062	230/400	0,37	2900	SAE 1 1/2"/SAE 1 1/2"	DKC-1800	1632	230/400	0,37	2900	SAE 1 1/2"/SAE 1 1/2"	DKC-2400	2148	230/400	0,55	2900	SAE 1 1/2"/SAE 1 1/2"	DKC-3300	3498	230/400	0,75	2900	SAE 1 1/2"/SAE 1 1/2"	DKC-5000	4662	400/690	1,1	2900	SAE 1 1/2"/SAE 1 1/2"	DKC-6000	6414	400/690	1,5	2900	SAE 2"/SAE 2"	Type	Débit l/h	Tension V	Moteur kW	Vitesse de rotation 1/min.	Raccordements aspir./refoul. DN/DN	DKC-200	276	230/400	0,18	950	SAE 1 1/2"/SAE 1 1/2"	DKC-450	438	230/400	0,25	1450	SAE 1 1/2"/SAE 1 1/2"	DKC-420	564	230/400	0,25	950	SAE 1 1/2"/SAE 1 1/2"	DKC-600	606	230/400	0,37	2900	SAE 1 1/2"/SAE 1 1/2"	DKC-900	912	230/400	0,55	2900	SAE 1 1/2"/SAE 1 1/2"	DKC-1200	1218	230/400	0,75	2900	SAE 1 1/2"/SAE 1 1/2"	DKC-1800	1818	230/400	1,1	2900	SAE 1 1/2"/SAE 1 1/2"	DKC-2400	2388	230/400	1,5	2900	SAE 1 1/2"/SAE 1 1/2"	DKC-3300	3786	230/400	2,2	2900	SAE 1 1/2"/SAE 1 1/2"	DKC-5000	5040	400/690	3	2900	SAE 1 1/2"/SAE 1 1/2"	DKC-6000	6900	400/690	3	2900	SAE 2"/SAE 2"
Type	Débit l/h	Tension V	Moteur kW	Vitesse de rotation 1/min.	Raccordements aspir./refoul. DN/DN																																																																																																																																												
DKC-200	150	230/400	0,18	950	SAE 1 1/2"/SAE 1 1/2"																																																																																																																																												
DKC-450	312	230/400	0,25	1450	SAE 1 1/2"/SAE 1 1/2"																																																																																																																																												
DKC-420	378	230/400	0,18	950	SAE 1 1/2"/SAE 1 1/2"																																																																																																																																												
DKC-600	510	230/400	0,37	2900	SAE 1 1/2"/SAE 1 1/2"																																																																																																																																												
DKC-900	780	230/400	0,37	2900	SAE 1 1/2"/SAE 1 1/2"																																																																																																																																												
DKC-1200	1062	230/400	0,37	2900	SAE 1 1/2"/SAE 1 1/2"																																																																																																																																												
DKC-1800	1632	230/400	0,37	2900	SAE 1 1/2"/SAE 1 1/2"																																																																																																																																												
DKC-2400	2148	230/400	0,55	2900	SAE 1 1/2"/SAE 1 1/2"																																																																																																																																												
DKC-3300	3498	230/400	0,75	2900	SAE 1 1/2"/SAE 1 1/2"																																																																																																																																												
DKC-5000	4662	400/690	1,1	2900	SAE 1 1/2"/SAE 1 1/2"																																																																																																																																												
DKC-6000	6414	400/690	1,5	2900	SAE 2"/SAE 2"																																																																																																																																												
Type	Débit l/h	Tension V	Moteur kW	Vitesse de rotation 1/min.	Raccordements aspir./refoul. DN/DN																																																																																																																																												
DKC-200	276	230/400	0,18	950	SAE 1 1/2"/SAE 1 1/2"																																																																																																																																												
DKC-450	438	230/400	0,25	1450	SAE 1 1/2"/SAE 1 1/2"																																																																																																																																												
DKC-420	564	230/400	0,25	950	SAE 1 1/2"/SAE 1 1/2"																																																																																																																																												
DKC-600	606	230/400	0,37	2900	SAE 1 1/2"/SAE 1 1/2"																																																																																																																																												
DKC-900	912	230/400	0,55	2900	SAE 1 1/2"/SAE 1 1/2"																																																																																																																																												
DKC-1200	1218	230/400	0,75	2900	SAE 1 1/2"/SAE 1 1/2"																																																																																																																																												
DKC-1800	1818	230/400	1,1	2900	SAE 1 1/2"/SAE 1 1/2"																																																																																																																																												
DKC-2400	2388	230/400	1,5	2900	SAE 1 1/2"/SAE 1 1/2"																																																																																																																																												
DKC-3300	3786	230/400	2,2	2900	SAE 1 1/2"/SAE 1 1/2"																																																																																																																																												
DKC-5000	5040	400/690	3	2900	SAE 1 1/2"/SAE 1 1/2"																																																																																																																																												
DKC-6000	6900	400/690	3	2900	SAE 2"/SAE 2"																																																																																																																																												
1.612	<p>Soupape de réglage de pression, allure 2 pour maintenir une pression constante dans les conduites fioul Les plages de pression ci-après sont réglées en fonction de la viscosité</p> <p>FOD, viscosité 5 cSt. 1 - 6 bar FOL, viscosité 152 cSt. 2 - 6 bar FOL, viscosité 380 cSt. 2.8 - 6 bar</p> <table border="1"> <thead> <tr> <th>Type</th> <th colspan="2">Débit l/h</th> <th>Raccordement</th> </tr> <tr> <td></td> <th>FOD min. - max.</th> <th>FOL min. - max.</th> <td></td> </tr> </thead> <tbody> <tr><td>B-PP</td><td>15 - 120</td><td>15 - 120</td><td>G 1/4</td></tr> <tr><td>B-P</td><td>24 - 300</td><td>24 - 270</td><td>G 3/8</td></tr> <tr><td>B-G</td><td>90 - 600</td><td>90 - 580</td><td>G 1/2</td></tr> <tr><td>B-GH-E/2</td><td>300 - 2000</td><td>300 - 1700</td><td>G 3/4</td></tr> <tr><td>B-GHG</td><td>900 - 5800</td><td>900 - 4800</td><td>G 1</td></tr> <tr><td>B-GHG</td><td>1500 - 8800</td><td>1500 - 8800</td><td>G 1 1/4</td></tr> </tbody> </table>	Type	Débit l/h		Raccordement		FOD min. - max.	FOL min. - max.		B-PP	15 - 120	15 - 120	G 1/4	B-P	24 - 300	24 - 270	G 3/8	B-G	90 - 600	90 - 580	G 1/2	B-GH-E/2	300 - 2000	300 - 1700	G 3/4	B-GHG	900 - 5800	900 - 4800	G 1	B-GHG	1500 - 8800	1500 - 8800	G 1 1/4																																																																																																																
Type	Débit l/h		Raccordement																																																																																																																																														
	FOD min. - max.	FOL min. - max.																																																																																																																																															
B-PP	15 - 120	15 - 120	G 1/4																																																																																																																																														
B-P	24 - 300	24 - 270	G 3/8																																																																																																																																														
B-G	90 - 600	90 - 580	G 1/2																																																																																																																																														
B-GH-E/2	300 - 2000	300 - 1700	G 3/4																																																																																																																																														
B-GHG	900 - 5800	900 - 4800	G 1																																																																																																																																														
B-GHG	1500 - 8800	1500 - 8800	G 1 1/4																																																																																																																																														

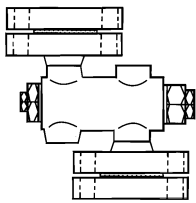

1.613

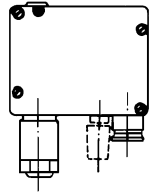

1.614

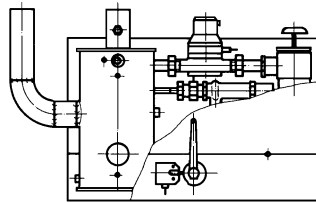

1.615 - 1.618

Nr.	Bezeichnung	Bestell-Nr. Order No. N° de commande	Preis EUR (o. MwSt.)																																																															
1.613	Druckregelventil mit Flanschanschluss auch für Anlagen nach TRD, inkl. Gegenflansche																																																																	
	<table border="0"> <tr> <td>Typ</td> <td colspan="2">Durchflussmenge</td> <td colspan="2">Anschluß</td> </tr> <tr> <td></td> <td>EL min. - max.</td> <td>S min. - max.</td> <td>DN</td> <td>PN</td> </tr> <tr> <td>FDR 15</td> <td>90 - 600</td> <td>90 - 580</td> <td>15</td> <td>40</td> </tr> <tr> <td>FDR 20</td> <td>300 - 2000</td> <td>300 - 1700</td> <td>20</td> <td>40</td> </tr> <tr> <td>FDR 25</td> <td>900 - 5800</td> <td>900 - 4800</td> <td>25</td> <td>40</td> </tr> <tr> <td>FDR 32/E-2</td> <td>1500 - 8800</td> <td>1500 - 8800</td> <td>32</td> <td>40</td> </tr> </table>	Typ	Durchflussmenge		Anschluß			EL min. - max.	S min. - max.	DN	PN	FDR 15	90 - 600	90 - 580	15	40	FDR 20	300 - 2000	300 - 1700	20	40	FDR 25	900 - 5800	900 - 4800	25	40	FDR 32/E-2	1500 - 8800	1500 - 8800	32	40	605 077 605 078 605 079 605 080																																		
Typ	Durchflussmenge		Anschluß																																																															
	EL min. - max.	S min. - max.	DN	PN																																																														
FDR 15	90 - 600	90 - 580	15	40																																																														
FDR 20	300 - 2000	300 - 1700	20	40																																																														
FDR 25	900 - 5800	900 - 4800	25	40																																																														
FDR 32/E-2	1500 - 8800	1500 - 8800	32	40																																																														
1.614	Druckwächter für Öl																																																																	
	<table border="0"> <tr> <td>Typ</td> <td>Druckbereich</td> <td></td> </tr> <tr> <td>DSB 143</td> <td>0-6 bar</td> <td>mit Anschlussteilen für Ölzirkulationsgerät</td> </tr> <tr> <td>DSB 143</td> <td>0-6 bar</td> <td>mit Anschlussteilen und Manometer -1/+9 bar für Ölzirkulationsgerät</td> </tr> <tr> <td>DSB 143</td> <td>0-6 bar</td> <td>ohne Anschlussteile und Manometer</td> </tr> </table>	Typ	Druckbereich		DSB 143	0-6 bar	mit Anschlussteilen für Ölzirkulationsgerät	DSB 143	0-6 bar	mit Anschlussteilen und Manometer -1/+9 bar für Ölzirkulationsgerät	DSB 143	0-6 bar	ohne Anschlussteile und Manometer	109 000 0474 2 109 000 0557 2 640 105																																																				
Typ	Druckbereich																																																																	
DSB 143	0-6 bar	mit Anschlussteilen für Ölzirkulationsgerät																																																																
DSB 143	0-6 bar	mit Anschlussteilen und Manometer -1/+9 bar für Ölzirkulationsgerät																																																																
DSB 143	0-6 bar	ohne Anschlussteile und Manometer																																																																
1.615	Ölzirkulationsgerät mit Ölfilter, Ölzähler und Grenztaster (Endschalter) für Heizöl EL und S auch für Anlagen nach TRD <i>mit Anschweißenden</i>																																																																	
	<table border="0"> <tr> <th>Bau- größe</th> <th>Heiz- öl</th> <th colspan="2">Bereich l/h</th> <th colspan="2">kg/h</th> <th>Heiz- leistung Watt</th> <th>Öl- inhalt dm³</th> <th></th> </tr> <tr> <td></td> <td></td> <th>min.</th> <th>max.</th> <th>min.</th> <th>max.</th> <td></td> <td></td> <td></td> </tr> <tr> <td>01</td> <td>EL</td> <td>4</td> <td>190</td> <td>3,4</td> <td>162</td> <td>-</td> <td>-</td> <td>109 000 0496 2</td> </tr> <tr> <td>2</td> <td>EL</td> <td>30</td> <td>1.330</td> <td>25</td> <td>1.130</td> <td>-</td> <td>7</td> <td>109 000 0477 2</td> </tr> <tr> <td>2</td> <td>S</td> <td>30</td> <td>1.330</td> <td>30</td> <td>1.330</td> <td>160</td> <td>7</td> <td>109 000 0478 2</td> </tr> <tr> <td>3</td> <td>EL</td> <td>75</td> <td>2.000</td> <td>64</td> <td>1.700</td> <td>-</td> <td>7,5</td> <td>109 000 0479 2</td> </tr> <tr> <td>3</td> <td>S</td> <td>75</td> <td>2.000</td> <td>75</td> <td>2.000</td> <td>160</td> <td>7,5</td> <td>109 000 0480 2</td> </tr> </table>	Bau- größe	Heiz- öl	Bereich l/h		kg/h		Heiz- leistung Watt	Öl- inhalt dm ³				min.	max.	min.	max.				01	EL	4	190	3,4	162	-	-	109 000 0496 2	2	EL	30	1.330	25	1.130	-	7	109 000 0477 2	2	S	30	1.330	30	1.330	160	7	109 000 0478 2	3	EL	75	2.000	64	1.700	-	7,5	109 000 0479 2	3	S	75	2.000	75	2.000	160	7,5	109 000 0480 2		
Bau- größe	Heiz- öl	Bereich l/h		kg/h		Heiz- leistung Watt	Öl- inhalt dm ³																																																											
		min.	max.	min.	max.																																																													
01	EL	4	190	3,4	162	-	-	109 000 0496 2																																																										
2	EL	30	1.330	25	1.130	-	7	109 000 0477 2																																																										
2	S	30	1.330	30	1.330	160	7	109 000 0478 2																																																										
3	EL	75	2.000	64	1.700	-	7,5	109 000 0479 2																																																										
3	S	75	2.000	75	2.000	160	7,5	109 000 0480 2																																																										
1.616	Flanschanschluss																																																																	
	<table border="0"> <tr> <td>2</td> <td>EL</td> <td>30</td> <td>1.330</td> <td>25</td> <td>1.130</td> <td>-</td> <td>7</td> <td>109 000 0553 2</td> </tr> <tr> <td>2</td> <td>S</td> <td>30</td> <td>1.330</td> <td>30</td> <td>1.330</td> <td>160</td> <td>7</td> <td>109 000 0554 2</td> </tr> <tr> <td>3</td> <td>EL</td> <td>75</td> <td>2.000</td> <td>64</td> <td>1.700</td> <td>-</td> <td>7,5</td> <td>109 000 0555 2</td> </tr> <tr> <td>3</td> <td>S</td> <td>75</td> <td>2.000</td> <td>64</td> <td>1.700</td> <td>160</td> <td>7,5</td> <td>109 000 0556 2</td> </tr> </table>	2	EL	30	1.330	25	1.130	-	7	109 000 0553 2	2	S	30	1.330	30	1.330	160	7	109 000 0554 2	3	EL	75	2.000	64	1.700	-	7,5	109 000 0555 2	3	S	75	2.000	64	1.700	160	7,5	109 000 0556 2																													
2	EL	30	1.330	25	1.130	-	7	109 000 0553 2																																																										
2	S	30	1.330	30	1.330	160	7	109 000 0554 2																																																										
3	EL	75	2.000	64	1.700	-	7,5	109 000 0555 2																																																										
3	S	75	2.000	64	1.700	160	7,5	109 000 0556 2																																																										
1.617	Ölzirkulationsgerät mit Ölfilter, Ölzähler mit Hochfrequenz-Impulsgeber und Grenztaster (Endschalter) für Heizöl EL und S, auch für Anlagen nach TRD <i>mit Anschweißenden</i>																																																																	
	<table border="0"> <tr> <th>Bau- größe</th> <th>Heiz- öl</th> <th colspan="2">Bereich l/h</th> <th colspan="2">kg/h</th> <th>Heiz- leistung Watt</th> <th>Öl- inhalt dm³</th> <th></th> </tr> <tr> <td></td> <td></td> <th>min.</th> <th>max.</th> <th>min.</th> <th>max.</th> <td></td> <td></td> <td></td> </tr> <tr> <td>01</td> <td>EL</td> <td>4</td> <td>190</td> <td>3,4</td> <td>162</td> <td>-</td> <td>2,5</td> <td>109 000 0505 2</td> </tr> <tr> <td>2</td> <td>EL</td> <td>30</td> <td>1.330</td> <td>25</td> <td>1.130</td> <td>-</td> <td>7</td> <td>109 000 0509 2</td> </tr> <tr> <td>2</td> <td>S</td> <td>30</td> <td>1.330</td> <td>30</td> <td>1.330</td> <td>160</td> <td>7</td> <td>109 000 0510 2</td> </tr> <tr> <td>3</td> <td>EL</td> <td>75</td> <td>2.000</td> <td>64</td> <td>1.700</td> <td>-</td> <td>7,5</td> <td>109 000 0511 2</td> </tr> <tr> <td>3</td> <td>S</td> <td>75</td> <td>2.000</td> <td>75</td> <td>2.000</td> <td>160</td> <td>7,5</td> <td>109 000 0512 2</td> </tr> </table>	Bau- größe	Heiz- öl	Bereich l/h		kg/h		Heiz- leistung Watt	Öl- inhalt dm ³				min.	max.	min.	max.				01	EL	4	190	3,4	162	-	2,5	109 000 0505 2	2	EL	30	1.330	25	1.130	-	7	109 000 0509 2	2	S	30	1.330	30	1.330	160	7	109 000 0510 2	3	EL	75	2.000	64	1.700	-	7,5	109 000 0511 2	3	S	75	2.000	75	2.000	160	7,5	109 000 0512 2		
Bau- größe	Heiz- öl	Bereich l/h		kg/h		Heiz- leistung Watt	Öl- inhalt dm ³																																																											
		min.	max.	min.	max.																																																													
01	EL	4	190	3,4	162	-	2,5	109 000 0505 2																																																										
2	EL	30	1.330	25	1.130	-	7	109 000 0509 2																																																										
2	S	30	1.330	30	1.330	160	7	109 000 0510 2																																																										
3	EL	75	2.000	64	1.700	-	7,5	109 000 0511 2																																																										
3	S	75	2.000	75	2.000	160	7,5	109 000 0512 2																																																										
1.618	Flanschanschluss																																																																	
	<table border="0"> <tr> <td>2</td> <td>EL</td> <td>30</td> <td>1.330</td> <td>25</td> <td>1.130</td> <td>-</td> <td>7</td> <td>109 000 0515 2</td> </tr> <tr> <td>2</td> <td>S</td> <td>30</td> <td>1.330</td> <td>30</td> <td>1.330</td> <td>160</td> <td>7</td> <td>109 000 0516 2</td> </tr> <tr> <td>3</td> <td>EL</td> <td>75</td> <td>2.000</td> <td>64</td> <td>1.700</td> <td>-</td> <td>7,5</td> <td>109 000 0517 2</td> </tr> <tr> <td>3</td> <td>S</td> <td>75</td> <td>2.000</td> <td>75</td> <td>2.000</td> <td>160</td> <td>7,5</td> <td>109 000 0518 2</td> </tr> </table>	2	EL	30	1.330	25	1.130	-	7	109 000 0515 2	2	S	30	1.330	30	1.330	160	7	109 000 0516 2	3	EL	75	2.000	64	1.700	-	7,5	109 000 0517 2	3	S	75	2.000	75	2.000	160	7,5	109 000 0518 2																													
2	EL	30	1.330	25	1.130	-	7	109 000 0515 2																																																										
2	S	30	1.330	30	1.330	160	7	109 000 0516 2																																																										
3	EL	75	2.000	64	1.700	-	7,5	109 000 0517 2																																																										
3	S	75	2.000	75	2.000	160	7,5	109 000 0518 2																																																										

No.	Description																																																								
1.613	<p>Pressure regulating valve with flange connection for installations to TRD, incl. counter flange</p> <table border="1"> <thead> <tr> <th>Type</th> <th colspan="2">Quantity of flow l/h</th> <th>DN</th> <th>PN</th> <th>Connection</th> </tr> <tr> <td></td> <th>EL min. - max.</th> <th>S min. - max.</th> <td></td> <td></td> <td></td> </tr> </thead> <tbody> <tr> <td>FDR 15</td> <td>90 - 600</td> <td>90 - 580</td> <td>15</td> <td>40</td> <td></td> </tr> <tr> <td>FDR 20</td> <td>300 - 2000</td> <td>300 - 1700</td> <td>20</td> <td>40</td> <td></td> </tr> <tr> <td>FDR 25</td> <td>900 - 5800</td> <td>900 - 4800</td> <td>25</td> <td>40</td> <td></td> </tr> <tr> <td>FDR 32/E-2</td> <td>1500 - 8800</td> <td>1500 - 8800</td> <td>32</td> <td>40</td> <td></td> </tr> </tbody> </table>	Type	Quantity of flow l/h		DN	PN	Connection		EL min. - max.	S min. - max.				FDR 15	90 - 600	90 - 580	15	40		FDR 20	300 - 2000	300 - 1700	20	40		FDR 25	900 - 5800	900 - 4800	25	40		FDR 32/E-2	1500 - 8800	1500 - 8800	32	40																					
Type	Quantity of flow l/h		DN	PN	Connection																																																				
	EL min. - max.	S min. - max.																																																							
FDR 15	90 - 600	90 - 580	15	40																																																					
FDR 20	300 - 2000	300 - 1700	20	40																																																					
FDR 25	900 - 5800	900 - 4800	25	40																																																					
FDR 32/E-2	1500 - 8800	1500 - 8800	32	40																																																					
1.614	<p>Pressure switch for oil</p> <table border="1"> <thead> <tr> <th>Type</th> <th>Pressure range</th> </tr> </thead> <tbody> <tr> <td>DSB 143</td> <td>0 - 6 bar with connections for oil circulation tank</td> </tr> <tr> <td>DSB 143</td> <td>0 - 6 bar with connections and press. gauge -1/+9 bar for oil circulation unit</td> </tr> <tr> <td>DSB 143</td> <td>0 - 6 bar without connections and pressure gauge</td> </tr> </tbody> </table>	Type	Pressure range	DSB 143	0 - 6 bar with connections for oil circulation tank	DSB 143	0 - 6 bar with connections and press. gauge -1/+9 bar for oil circulation unit	DSB 143	0 - 6 bar without connections and pressure gauge																																																
Type	Pressure range																																																								
DSB 143	0 - 6 bar with connections for oil circulation tank																																																								
DSB 143	0 - 6 bar with connections and press. gauge -1/+9 bar for oil circulation unit																																																								
DSB 143	0 - 6 bar without connections and pressure gauge																																																								
1.615	<p>Oil circulation tank, with oil filter, oil meter and limit switch for oil EL and S, for installations to TRD with welding ends</p> <table border="1"> <thead> <tr> <th>Size</th> <th>Fuel oil</th> <th colspan="2">Range l/h</th> <th colspan="2">kg/h</th> <th>Heat rating Watt</th> <th>Oil content dm³</th> </tr> <tr> <td></td> <td></td> <th>min.</th> <th>max.</th> <th>min.</th> <th>max.</th> <td></td> <td></td> </tr> </thead> <tbody> <tr> <td>01</td> <td>EL</td> <td>4</td> <td>190</td> <td>3.4</td> <td>162</td> <td>-</td> <td>-</td> </tr> <tr> <td>2</td> <td>EL</td> <td>30</td> <td>1.330</td> <td>25</td> <td>1.130</td> <td>-</td> <td>7</td> </tr> <tr> <td>2</td> <td>S</td> <td>30</td> <td>1.330</td> <td>30</td> <td>1.330</td> <td>160</td> <td>7</td> </tr> <tr> <td>3</td> <td>EL</td> <td>75</td> <td>2.000</td> <td>64</td> <td>1.700</td> <td>-</td> <td>7,5</td> </tr> <tr> <td>3</td> <td>S</td> <td>75</td> <td>2.000</td> <td>75</td> <td>2.000</td> <td>160</td> <td>7,5</td> </tr> </tbody> </table>	Size	Fuel oil	Range l/h		kg/h		Heat rating Watt	Oil content dm ³			min.	max.	min.	max.			01	EL	4	190	3.4	162	-	-	2	EL	30	1.330	25	1.130	-	7	2	S	30	1.330	30	1.330	160	7	3	EL	75	2.000	64	1.700	-	7,5	3	S	75	2.000	75	2.000	160	7,5
Size	Fuel oil	Range l/h		kg/h		Heat rating Watt	Oil content dm ³																																																		
		min.	max.	min.	max.																																																				
01	EL	4	190	3.4	162	-	-																																																		
2	EL	30	1.330	25	1.130	-	7																																																		
2	S	30	1.330	30	1.330	160	7																																																		
3	EL	75	2.000	64	1.700	-	7,5																																																		
3	S	75	2.000	75	2.000	160	7,5																																																		
1.616	<p>Flange connection</p> <table border="1"> <thead> <tr> <th>Size</th> <th>Fuel oil</th> <th colspan="2">Range l/h</th> <th colspan="2">kg/h</th> <th>Heat rating Watt</th> <th>Oil content dm³</th> </tr> <tr> <td></td> <td></td> <th>min.</th> <th>max.</th> <th>min.</th> <th>max.</th> <td></td> <td></td> </tr> </thead> <tbody> <tr> <td>2</td> <td>EL</td> <td>30</td> <td>1.330</td> <td>25</td> <td>1.130</td> <td>-</td> <td>7</td> </tr> <tr> <td>2</td> <td>S</td> <td>30</td> <td>1.330</td> <td>30</td> <td>1.330</td> <td>160</td> <td>7</td> </tr> <tr> <td>3</td> <td>EL</td> <td>75</td> <td>2.000</td> <td>64</td> <td>1.700</td> <td>-</td> <td>7,5</td> </tr> <tr> <td>3</td> <td>S</td> <td>75</td> <td>2.000</td> <td>64</td> <td>1.700</td> <td>160</td> <td>7,5</td> </tr> </tbody> </table>	Size	Fuel oil	Range l/h		kg/h		Heat rating Watt	Oil content dm ³			min.	max.	min.	max.			2	EL	30	1.330	25	1.130	-	7	2	S	30	1.330	30	1.330	160	7	3	EL	75	2.000	64	1.700	-	7,5	3	S	75	2.000	64	1.700	160	7,5								
Size	Fuel oil	Range l/h		kg/h		Heat rating Watt	Oil content dm ³																																																		
		min.	max.	min.	max.																																																				
2	EL	30	1.330	25	1.130	-	7																																																		
2	S	30	1.330	30	1.330	160	7																																																		
3	EL	75	2.000	64	1.700	-	7,5																																																		
3	S	75	2.000	64	1.700	160	7,5																																																		
1.617	<p>Oil circulation tank with oil filter, oil meter with high frequency impulse generator and limit switch for oil EL and S for installations to TRD with welding ends</p> <table border="1"> <thead> <tr> <th>Size</th> <th>Fuel oil</th> <th colspan="2">Range l/h</th> <th colspan="2">kg/h</th> <th>Heat rating Watt</th> <th>Oil content dm³</th> </tr> <tr> <td></td> <td></td> <th>min.</th> <th>max.</th> <th>min.</th> <th>max.</th> <td></td> <td></td> </tr> </thead> <tbody> <tr> <td>01</td> <td>EL</td> <td>4</td> <td>190</td> <td>3.4</td> <td>162</td> <td>-</td> <td>2,5</td> </tr> <tr> <td>2</td> <td>EL</td> <td>30</td> <td>1.330</td> <td>25</td> <td>1.130</td> <td>-</td> <td>7</td> </tr> <tr> <td>2</td> <td>S</td> <td>30</td> <td>1.330</td> <td>30</td> <td>1.330</td> <td>160</td> <td>7</td> </tr> <tr> <td>3</td> <td>EL</td> <td>75</td> <td>2.000</td> <td>64</td> <td>1.700</td> <td>-</td> <td>7,5</td> </tr> <tr> <td>3</td> <td>S</td> <td>75</td> <td>2.000</td> <td>75</td> <td>2.000</td> <td>160</td> <td>7,5</td> </tr> </tbody> </table>	Size	Fuel oil	Range l/h		kg/h		Heat rating Watt	Oil content dm ³			min.	max.	min.	max.			01	EL	4	190	3.4	162	-	2,5	2	EL	30	1.330	25	1.130	-	7	2	S	30	1.330	30	1.330	160	7	3	EL	75	2.000	64	1.700	-	7,5	3	S	75	2.000	75	2.000	160	7,5
Size	Fuel oil	Range l/h		kg/h		Heat rating Watt	Oil content dm ³																																																		
		min.	max.	min.	max.																																																				
01	EL	4	190	3.4	162	-	2,5																																																		
2	EL	30	1.330	25	1.130	-	7																																																		
2	S	30	1.330	30	1.330	160	7																																																		
3	EL	75	2.000	64	1.700	-	7,5																																																		
3	S	75	2.000	75	2.000	160	7,5																																																		
1.618	<p>Flange connection</p> <table border="1"> <thead> <tr> <th>Size</th> <th>Fuel oil</th> <th colspan="2">Range l/h</th> <th colspan="2">kg/h</th> <th>Heat rating Watt</th> <th>Oil content dm³</th> </tr> <tr> <td></td> <td></td> <th>min.</th> <th>max.</th> <th>min.</th> <th>max.</th> <td></td> <td></td> </tr> </thead> <tbody> <tr> <td>2</td> <td>EL</td> <td>30</td> <td>1.330</td> <td>25</td> <td>1.130</td> <td>-</td> <td>7</td> </tr> <tr> <td>2</td> <td>S</td> <td>30</td> <td>1.330</td> <td>30</td> <td>1.330</td> <td>160</td> <td>7</td> </tr> <tr> <td>3</td> <td>EL</td> <td>75</td> <td>2.000</td> <td>64</td> <td>1.700</td> <td>-</td> <td>7,5</td> </tr> <tr> <td>3</td> <td>S</td> <td>75</td> <td>2.000</td> <td>75</td> <td>2.000</td> <td>160</td> <td>7,5</td> </tr> </tbody> </table>	Size	Fuel oil	Range l/h		kg/h		Heat rating Watt	Oil content dm ³			min.	max.	min.	max.			2	EL	30	1.330	25	1.130	-	7	2	S	30	1.330	30	1.330	160	7	3	EL	75	2.000	64	1.700	-	7,5	3	S	75	2.000	75	2.000	160	7,5								
Size	Fuel oil	Range l/h		kg/h		Heat rating Watt	Oil content dm ³																																																		
		min.	max.	min.	max.																																																				
2	EL	30	1.330	25	1.130	-	7																																																		
2	S	30	1.330	30	1.330	160	7																																																		
3	EL	75	2.000	64	1.700	-	7,5																																																		
3	S	75	2.000	75	2.000	160	7,5																																																		

No.	Dénomination																																																								
1.613	<p>Soupape de réglage de pression avec bride pour installations selon TRD y compris contre-bride</p> <table border="1"> <thead> <tr> <th>Type</th> <th colspan="2">Débit l/h</th> <th>DN</th> <th>PN</th> <th>Raccordement</th> </tr> <tr> <td></td> <th>FOD min. - max.</th> <th>FOL min. - max.</th> <td></td> <td></td> <td></td> </tr> </thead> <tbody> <tr> <td>FDR 15</td> <td>90 - 600</td> <td>90 - 580</td> <td>15</td> <td>40</td> <td></td> </tr> <tr> <td>FDR 20</td> <td>300 - 2000</td> <td>300 - 1700</td> <td>20</td> <td>40</td> <td></td> </tr> <tr> <td>FDR 25</td> <td>900 - 5800</td> <td>900 - 4800</td> <td>25</td> <td>40</td> <td></td> </tr> <tr> <td>FDR 32/E-2</td> <td>1500 - 8800</td> <td>1500 - 8800</td> <td>32</td> <td>40</td> <td></td> </tr> </tbody> </table>	Type	Débit l/h		DN	PN	Raccordement		FOD min. - max.	FOL min. - max.				FDR 15	90 - 600	90 - 580	15	40		FDR 20	300 - 2000	300 - 1700	20	40		FDR 25	900 - 5800	900 - 4800	25	40		FDR 32/E-2	1500 - 8800	1500 - 8800	32	40																					
Type	Débit l/h		DN	PN	Raccordement																																																				
	FOD min. - max.	FOL min. - max.																																																							
FDR 15	90 - 600	90 - 580	15	40																																																					
FDR 20	300 - 2000	300 - 1700	20	40																																																					
FDR 25	900 - 5800	900 - 4800	25	40																																																					
FDR 32/E-2	1500 - 8800	1500 - 8800	32	40																																																					
1.614	<p>Pressostat pour fioul</p> <table border="1"> <thead> <tr> <th>Type</th> <th>Plage de pression</th> </tr> </thead> <tbody> <tr> <td>DSB 143</td> <td>0-6 bar avec éléments de raccordement pour pot de circulation</td> </tr> <tr> <td>DSB 143</td> <td>0-6 bar avec éléments de raccordement et manomètre -1/+9 bar pour pot de circulation</td> </tr> <tr> <td>DSB 143</td> <td>0-6 bar sans éléments de raccordement et manomètre</td> </tr> </tbody> </table>	Type	Plage de pression	DSB 143	0-6 bar avec éléments de raccordement pour pot de circulation	DSB 143	0-6 bar avec éléments de raccordement et manomètre -1/+9 bar pour pot de circulation	DSB 143	0-6 bar sans éléments de raccordement et manomètre																																																
Type	Plage de pression																																																								
DSB 143	0-6 bar avec éléments de raccordement pour pot de circulation																																																								
DSB 143	0-6 bar avec éléments de raccordement et manomètre -1/+9 bar pour pot de circulation																																																								
DSB 143	0-6 bar sans éléments de raccordement et manomètre																																																								
1.615	<p>Pot de circulation avec filtre, compteur et fin de course de positionnement pour FOD et FOL et également pour installations selon TRD avec raccords à souder</p> <table border="1"> <thead> <tr> <th>Grandeur</th> <th>Fioul</th> <th colspan="2">Plage l/h</th> <th colspan="2">kg/h</th> <th>Puissance réchauffage Watt</th> <th>Contenance fioul dm³</th> </tr> <tr> <td></td> <td></td> <th>min.</th> <th>max.</th> <th>min.</th> <th>max.</th> <td></td> <td></td> </tr> </thead> <tbody> <tr> <td>01</td> <td>FOD</td> <td>4</td> <td>190</td> <td>3,4</td> <td>162</td> <td>-</td> <td>-</td> </tr> <tr> <td>2</td> <td>FOD</td> <td>30</td> <td>1.330</td> <td>25</td> <td>1.130</td> <td>-</td> <td>7</td> </tr> <tr> <td>2</td> <td>FOL</td> <td>30</td> <td>1.330</td> <td>30</td> <td>1.330</td> <td>160</td> <td>7</td> </tr> <tr> <td>3</td> <td>FOD</td> <td>75</td> <td>2.000</td> <td>64</td> <td>1.700</td> <td>-</td> <td>7,5</td> </tr> <tr> <td>3</td> <td>FOL</td> <td>75</td> <td>2.000</td> <td>75</td> <td>2.000</td> <td>160</td> <td>7,5</td> </tr> </tbody> </table>	Grandeur	Fioul	Plage l/h		kg/h		Puissance réchauffage Watt	Contenance fioul dm ³			min.	max.	min.	max.			01	FOD	4	190	3,4	162	-	-	2	FOD	30	1.330	25	1.130	-	7	2	FOL	30	1.330	30	1.330	160	7	3	FOD	75	2.000	64	1.700	-	7,5	3	FOL	75	2.000	75	2.000	160	7,5
Grandeur	Fioul	Plage l/h		kg/h		Puissance réchauffage Watt	Contenance fioul dm ³																																																		
		min.	max.	min.	max.																																																				
01	FOD	4	190	3,4	162	-	-																																																		
2	FOD	30	1.330	25	1.130	-	7																																																		
2	FOL	30	1.330	30	1.330	160	7																																																		
3	FOD	75	2.000	64	1.700	-	7,5																																																		
3	FOL	75	2.000	75	2.000	160	7,5																																																		
1.616	<p>Raccords à brides</p> <table border="1"> <thead> <tr> <th>Grandeur</th> <th>Fioul</th> <th colspan="2">Plage l/h</th> <th colspan="2">kg/h</th> <th>Puissance réchauffage Watt</th> <th>Contenance fioul dm³</th> </tr> <tr> <td></td> <td></td> <th>min.</th> <th>max.</th> <th>min.</th> <th>max.</th> <td></td> <td></td> </tr> </thead> <tbody> <tr> <td>2</td> <td>FOD</td> <td>30</td> <td>1.330</td> <td>25</td> <td>1.130</td> <td>-</td> <td>7</td> </tr> <tr> <td>2</td> <td>FOL</td> <td>30</td> <td>1.330</td> <td>30</td> <td>1.330</td> <td>160</td> <td>7</td> </tr> <tr> <td>3</td> <td>FOD</td> <td>75</td> <td>2.000</td> <td>64</td> <td>1.700</td> <td>-</td> <td>7,5</td> </tr> <tr> <td>3</td> <td>FOL</td> <td>75</td> <td>2.000</td> <td>64</td> <td>1.700</td> <td>160</td> <td>7,5</td> </tr> </tbody> </table>	Grandeur	Fioul	Plage l/h		kg/h		Puissance réchauffage Watt	Contenance fioul dm ³			min.	max.	min.	max.			2	FOD	30	1.330	25	1.130	-	7	2	FOL	30	1.330	30	1.330	160	7	3	FOD	75	2.000	64	1.700	-	7,5	3	FOL	75	2.000	64	1.700	160	7,5								
Grandeur	Fioul	Plage l/h		kg/h		Puissance réchauffage Watt	Contenance fioul dm ³																																																		
		min.	max.	min.	max.																																																				
2	FOD	30	1.330	25	1.130	-	7																																																		
2	FOL	30	1.330	30	1.330	160	7																																																		
3	FOD	75	2.000	64	1.700	-	7,5																																																		
3	FOL	75	2.000	64	1.700	160	7,5																																																		
1.617	<p>Pot de circulation avec filtre, compteur avec émetteur d'impulsions hautes fréquences et fin de course de positionnement pour FOD et FOL, également pour installations selon TRD avec raccords à souder</p> <table border="1"> <thead> <tr> <th>Grandeur</th> <th>Fioul</th> <th colspan="2">Plage l/h</th> <th colspan="2">kg/h</th> <th>Puissance réchauffage Watt</th> <th>Contenance fioul dm³</th> </tr> <tr> <td></td> <td></td> <th>min.</th> <th>max.</th> <th>min.</th> <th>max.</th> <td></td> <td></td> </tr> </thead> <tbody> <tr> <td>01</td> <td>FOD</td> <td>4</td> <td>190</td> <td>3,4</td> <td>162</td> <td>-</td> <td>2,5</td> </tr> <tr> <td>2</td> <td>FOD</td> <td>30</td> <td>1.330</td> <td>25</td> <td>1.130</td> <td>-</td> <td>7</td> </tr> <tr> <td>2</td> <td>FOL</td> <td>30</td> <td>1.330</td> <td>30</td> <td>1.330</td> <td>160</td> <td>7</td> </tr> <tr> <td>3</td> <td>FOD</td> <td>75</td> <td>2.000</td> <td>64</td> <td>1.700</td> <td>-</td> <td>7,5</td> </tr> <tr> <td>3</td> <td>FOL</td> <td>75</td> <td>2.000</td> <td>75</td> <td>2.000</td> <td>160</td> <td>7,5</td> </tr> </tbody> </table>	Grandeur	Fioul	Plage l/h		kg/h		Puissance réchauffage Watt	Contenance fioul dm ³			min.	max.	min.	max.			01	FOD	4	190	3,4	162	-	2,5	2	FOD	30	1.330	25	1.130	-	7	2	FOL	30	1.330	30	1.330	160	7	3	FOD	75	2.000	64	1.700	-	7,5	3	FOL	75	2.000	75	2.000	160	7,5
Grandeur	Fioul	Plage l/h		kg/h		Puissance réchauffage Watt	Contenance fioul dm ³																																																		
		min.	max.	min.	max.																																																				
01	FOD	4	190	3,4	162	-	2,5																																																		
2	FOD	30	1.330	25	1.130	-	7																																																		
2	FOL	30	1.330	30	1.330	160	7																																																		
3	FOD	75	2.000	64	1.700	-	7,5																																																		
3	FOL	75	2.000	75	2.000	160	7,5																																																		
1.618	<p>Raccords à brides</p> <table border="1"> <thead> <tr> <th>Grandeur</th> <th>Fioul</th> <th colspan="2">Plage l/h</th> <th colspan="2">kg/h</th> <th>Puissance réchauffage Watt</th> <th>Contenance fioul dm³</th> </tr> <tr> <td></td> <td></td> <th>min.</th> <th>max.</th> <th>min.</th> <th>max.</th> <td></td> <td></td> </tr> </thead> <tbody> <tr> <td>2</td> <td>FOD</td> <td>30</td> <td>1.330</td> <td>25</td> <td>1.130</td> <td>-</td> <td>7</td> </tr> <tr> <td>2</td> <td>FOL</td> <td>30</td> <td>1.330</td> <td>30</td> <td>1.330</td> <td>160</td> <td>7</td> </tr> <tr> <td>3</td> <td>FOD</td> <td>75</td> <td>2.000</td> <td>64</td> <td>1.700</td> <td>-</td> <td>7,5</td> </tr> <tr> <td>3</td> <td>FOL</td> <td>75</td> <td>2.000</td> <td>75</td> <td>2.000</td> <td>160</td> <td>7,5</td> </tr> </tbody> </table>	Grandeur	Fioul	Plage l/h		kg/h		Puissance réchauffage Watt	Contenance fioul dm ³			min.	max.	min.	max.			2	FOD	30	1.330	25	1.130	-	7	2	FOL	30	1.330	30	1.330	160	7	3	FOD	75	2.000	64	1.700	-	7,5	3	FOL	75	2.000	75	2.000	160	7,5								
Grandeur	Fioul	Plage l/h		kg/h		Puissance réchauffage Watt	Contenance fioul dm ³																																																		
		min.	max.	min.	max.																																																				
2	FOD	30	1.330	25	1.130	-	7																																																		
2	FOL	30	1.330	30	1.330	160	7																																																		
3	FOD	75	2.000	64	1.700	-	7,5																																																		
3	FOL	75	2.000	75	2.000	160	7,5																																																		

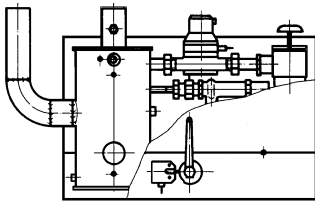

1.619 - 1.620



1.621

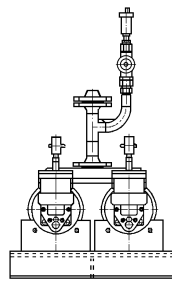

1.701
1.702



1.703

Nr.	Bezeichnung	Bestell-Nr. Order No. N° de commande	Preis EUR (o. MwSt.)																																																																																										
1.619	Öl-zirkulationsgerät mit Ölfilter, Öl-zähler mit Niederfrequenz-Impulsgeber und Grenztaster (Endschalter) für Heizöl EL und S, auch für Anlagen nach TRD mit Anschweißenden																																																																																												
	<table border="1"> <thead> <tr> <th>Baugröße</th> <th>Heizöl</th> <th>Bereich l/h</th> <th>kg/h</th> <th>Heizleistung Watt</th> <th>Öl-inhalt dm³</th> </tr> </thead> <tbody> <tr> <td>01</td> <td>EL</td> <td>4</td> <td>3,4</td> <td>-</td> <td>2,5</td> </tr> <tr> <td>2</td> <td>EL</td> <td>30</td> <td>25</td> <td>-</td> <td>7</td> </tr> <tr> <td>2</td> <td>S</td> <td>30</td> <td>30</td> <td>160</td> <td>7</td> </tr> <tr> <td>3</td> <td>EL</td> <td>75</td> <td>64</td> <td>-</td> <td>7,5</td> </tr> <tr> <td>3</td> <td>S</td> <td>75</td> <td>75</td> <td>160</td> <td>7,5</td> </tr> </tbody> </table>	Baugröße	Heizöl	Bereich l/h	kg/h	Heizleistung Watt	Öl-inhalt dm ³	01	EL	4	3,4	-	2,5	2	EL	30	25	-	7	2	S	30	30	160	7	3	EL	75	64	-	7,5	3	S	75	75	160	7,5	109 000 0506 2																																																							
Baugröße	Heizöl	Bereich l/h	kg/h	Heizleistung Watt	Öl-inhalt dm ³																																																																																								
01	EL	4	3,4	-	2,5																																																																																								
2	EL	30	25	-	7																																																																																								
2	S	30	30	160	7																																																																																								
3	EL	75	64	-	7,5																																																																																								
3	S	75	75	160	7,5																																																																																								
1.620	Flanschanschluss																																																																																												
	<table border="1"> <thead> <tr> <th>Baugröße</th> <th>Heizöl</th> <th>Bereich l/h</th> <th>kg/h</th> <th>Heizleistung Watt</th> <th>Öl-inhalt dm³</th> </tr> </thead> <tbody> <tr> <td>2</td> <td>EL</td> <td>30</td> <td>25</td> <td>-</td> <td>7</td> </tr> <tr> <td>2</td> <td>S</td> <td>30</td> <td>30</td> <td>160</td> <td>7</td> </tr> <tr> <td>3</td> <td>EL</td> <td>75</td> <td>64</td> <td>-</td> <td>7,5</td> </tr> <tr> <td>3</td> <td>S</td> <td>75</td> <td>75</td> <td>160</td> <td>7,5</td> </tr> </tbody> </table>	Baugröße	Heizöl	Bereich l/h	kg/h	Heizleistung Watt	Öl-inhalt dm ³	2	EL	30	25	-	7	2	S	30	30	160	7	3	EL	75	64	-	7,5	3	S	75	75	160	7,5	109 000 0527 2 109 000 0528 2 109 000 0529 2 109 000 0530 2																																																													
Baugröße	Heizöl	Bereich l/h	kg/h	Heizleistung Watt	Öl-inhalt dm ³																																																																																								
2	EL	30	25	-	7																																																																																								
2	S	30	30	160	7																																																																																								
3	EL	75	64	-	7,5																																																																																								
3	S	75	75	160	7,5																																																																																								
	Hinweis: Relais KFA6 bei NF-Impulsgeber und Frequenzstromumsetzer KFU8 bei HF-Impulsgeber verwenden (siehe Pos. 1.514 und 1.515). Baugröße 01 – Öl-zähler VZO 8 eingebaut Baugröße 2 – Öl-zähler VZO 20 eingebaut Baugröße 3 – Öl-zähler VZO 25 eingebaut																																																																																												
1.621	Drossel zum Abgleich der Durchflusswiderstände bei Schwerölbetrieb DN32 (für Baugröße 1) DN50 (für Baugröße 2) DN65 (für Baugröße 3)	109 000 0337 2 109 000 0338 2 109 000 0339 2																																																																																											
1.622	Manometer -1 bis +9 bar, zum Anbau am Öl-zirkulationsgerät	109 000 0321 2																																																																																											
1.623	0 - 6 bar Ringleitung	109 000 0587 2																																																																																											
1.624	Vakuum Manometer -1/+5 bar Ringleitung	109 000 0588 2																																																																																											
1.7	Einstrangarmaturen / Heizölleckmelder																																																																																												
	Pumpenaggregat, Einstrang (Lieferzeit muß projektbezogen angefragt werden)																																																																																												
1.701	Einzelaggregat																																																																																												
	<table border="1"> <thead> <tr> <th>Typ</th> <th>Eff. Förderstrom*) l/h</th> <th>Max. Dauerentnahmemenge l/h</th> <th>Saug-/Druckseite DN</th> <th>Gegenflansche PN</th> <th>Motor Volt</th> <th>Hz</th> <th>kW</th> <th>Nenn-drehzahl 1/min</th> </tr> </thead> <tbody> <tr><td>BASD 150</td><td>155</td><td>125</td><td>20/20</td><td>16</td><td>230/400</td><td>50</td><td>0,25</td><td>910</td></tr> <tr><td>BASD 250</td><td>260</td><td>230</td><td>20/20</td><td>16</td><td>230/400</td><td>50</td><td>0,37</td><td>1400</td></tr> <tr><td>BASD 350</td><td>397</td><td>367</td><td>20/20</td><td>16</td><td>230/400</td><td>50</td><td>0,37</td><td>1400</td></tr> <tr><td>BASD 550</td><td>535</td><td>435</td><td>20/20</td><td>16</td><td>230/400</td><td>50</td><td>0,37</td><td>1400</td></tr> <tr><td>BASD 850</td><td>846</td><td>746</td><td>20/20</td><td>16</td><td>230/400</td><td>50</td><td>0,55</td><td>2800</td></tr> <tr><td>BASD 1150</td><td>1140</td><td>1040</td><td>20/20</td><td>16</td><td>230/400</td><td>50</td><td>0,55</td><td>2800</td></tr> <tr><td>BASD 1650</td><td>1602</td><td>1502</td><td>20/20</td><td>16</td><td>230/400</td><td>50</td><td>0,55</td><td>2800</td></tr> <tr><td>BASD 2250</td><td>2256</td><td>1956</td><td>25/25</td><td>16</td><td>230/400</td><td>50</td><td>1,1</td><td>2800</td></tr> <tr><td>BASD 3150</td><td>3168</td><td>2868</td><td>25/25</td><td>16</td><td>230/400</td><td>50</td><td>1,1</td><td>2800</td></tr> </tbody> </table>	Typ	Eff. Förderstrom*) l/h	Max. Dauerentnahmemenge l/h	Saug-/Druckseite DN	Gegenflansche PN	Motor Volt	Hz	kW	Nenn-drehzahl 1/min	BASD 150	155	125	20/20	16	230/400	50	0,25	910	BASD 250	260	230	20/20	16	230/400	50	0,37	1400	BASD 350	397	367	20/20	16	230/400	50	0,37	1400	BASD 550	535	435	20/20	16	230/400	50	0,37	1400	BASD 850	846	746	20/20	16	230/400	50	0,55	2800	BASD 1150	1140	1040	20/20	16	230/400	50	0,55	2800	BASD 1650	1602	1502	20/20	16	230/400	50	0,55	2800	BASD 2250	2256	1956	25/25	16	230/400	50	1,1	2800	BASD 3150	3168	2868	25/25	16	230/400	50	1,1	2800	601 650 601 651 601 652 601 653 601 654 601 655 601 656 601 657 601 658	
Typ	Eff. Förderstrom*) l/h	Max. Dauerentnahmemenge l/h	Saug-/Druckseite DN	Gegenflansche PN	Motor Volt	Hz	kW	Nenn-drehzahl 1/min																																																																																					
BASD 150	155	125	20/20	16	230/400	50	0,25	910																																																																																					
BASD 250	260	230	20/20	16	230/400	50	0,37	1400																																																																																					
BASD 350	397	367	20/20	16	230/400	50	0,37	1400																																																																																					
BASD 550	535	435	20/20	16	230/400	50	0,37	1400																																																																																					
BASD 850	846	746	20/20	16	230/400	50	0,55	2800																																																																																					
BASD 1150	1140	1040	20/20	16	230/400	50	0,55	2800																																																																																					
BASD 1650	1602	1502	20/20	16	230/400	50	0,55	2800																																																																																					
BASD 2250	2256	1956	25/25	16	230/400	50	1,1	2800																																																																																					
BASD 3150	3168	2868	25/25	16	230/400	50	1,1	2800																																																																																					
1.702	Doppelaggregat																																																																																												
	<table border="1"> <thead> <tr> <th>Typ</th> <th>Eff. Förderstrom*) l/h</th> <th>Max. Dauerentnahmemenge l/h</th> <th>Saug-/Druckseite DN</th> <th>Gegenflansche PN</th> <th>Motor Volt</th> <th>Hz</th> <th>kW</th> <th>Nenn-drehzahl 1/min</th> </tr> </thead> <tbody> <tr><td>ZASD 150</td><td>155</td><td>125</td><td>25/20</td><td>16</td><td>230/400</td><td>50</td><td>0,25</td><td>910</td></tr> <tr><td>ZASD 250</td><td>260</td><td>230</td><td>25/20</td><td>16</td><td>230/400</td><td>50</td><td>0,37</td><td>1400</td></tr> <tr><td>ZASD 350</td><td>397</td><td>367</td><td>25/20</td><td>16</td><td>230/400</td><td>50</td><td>0,37</td><td>1400</td></tr> <tr><td>ZASD 550</td><td>535</td><td>435</td><td>25/20</td><td>16</td><td>230/400</td><td>50</td><td>0,37</td><td>1400</td></tr> <tr><td>ZASD 850</td><td>846</td><td>746</td><td>25/20</td><td>16</td><td>230/400</td><td>50</td><td>0,55</td><td>2800</td></tr> <tr><td>ZASD 1150</td><td>1140</td><td>1040</td><td>25/20</td><td>16</td><td>230/400</td><td>50</td><td>0,55</td><td>2800</td></tr> <tr><td>ZASD 1650</td><td>1602</td><td>1502</td><td>25/20</td><td>16</td><td>230/400</td><td>50</td><td>0,55</td><td>2800</td></tr> <tr><td>ZASD 2250</td><td>2256</td><td>1956</td><td>32/25</td><td>16</td><td>230/400</td><td>50</td><td>1,1</td><td>2800</td></tr> <tr><td>ZASD 3150</td><td>3168</td><td>2868</td><td>32/25</td><td>16</td><td>230/400</td><td>50</td><td>1,1</td><td>2800</td></tr> </tbody> </table>	Typ	Eff. Förderstrom*) l/h	Max. Dauerentnahmemenge l/h	Saug-/Druckseite DN	Gegenflansche PN	Motor Volt	Hz	kW	Nenn-drehzahl 1/min	ZASD 150	155	125	25/20	16	230/400	50	0,25	910	ZASD 250	260	230	25/20	16	230/400	50	0,37	1400	ZASD 350	397	367	25/20	16	230/400	50	0,37	1400	ZASD 550	535	435	25/20	16	230/400	50	0,37	1400	ZASD 850	846	746	25/20	16	230/400	50	0,55	2800	ZASD 1150	1140	1040	25/20	16	230/400	50	0,55	2800	ZASD 1650	1602	1502	25/20	16	230/400	50	0,55	2800	ZASD 2250	2256	1956	32/25	16	230/400	50	1,1	2800	ZASD 3150	3168	2868	32/25	16	230/400	50	1,1	2800	601 659 601 660 601 661 601 662 601 663 601 664 601 665 601 666 601 667	
Typ	Eff. Förderstrom*) l/h	Max. Dauerentnahmemenge l/h	Saug-/Druckseite DN	Gegenflansche PN	Motor Volt	Hz	kW	Nenn-drehzahl 1/min																																																																																					
ZASD 150	155	125	25/20	16	230/400	50	0,25	910																																																																																					
ZASD 250	260	230	25/20	16	230/400	50	0,37	1400																																																																																					
ZASD 350	397	367	25/20	16	230/400	50	0,37	1400																																																																																					
ZASD 550	535	435	25/20	16	230/400	50	0,37	1400																																																																																					
ZASD 850	846	746	25/20	16	230/400	50	0,55	2800																																																																																					
ZASD 1150	1140	1040	25/20	16	230/400	50	0,55	2800																																																																																					
ZASD 1650	1602	1502	25/20	16	230/400	50	0,55	2800																																																																																					
ZASD 2250	2256	1956	32/25	16	230/400	50	1,1	2800																																																																																					
ZASD 3150	3168	2868	32/25	16	230/400	50	1,1	2800																																																																																					
	Die angegebenen Werte gelten für eine Pumpe!) bei Δp=4 bar, v=6 mm ² /s																																																																																												
1.703	Heizölleckmelder mit Steckergehäuse HMS	601 498																																																																																											

No. Description

1.619 **Oil circulation unit with filter, oil meter with low frequency impulse generator and limit switch for oil EL and S, suitable for installations to TRD with welding ends**

Size	Fuel oil	Range l/h	kg/h	Heat rating Watt	Oil content dm ³
		min. max.	min. max.		
01	EL	4 190	3.4 162	-	2,5
2	EL	30 1.330	25 1.130	-	7
2	S	30 1.330	25 1.330	160	7
3	EL	75 2.000	64 1.700	-	7,5
3	S	75 2.000	75 2.000	160	7,5

1.620 **Flange connection**

Size	Fuel oil	Range l/h	kg/h	Heat rating Watt	Oil content dm ³
		min. max.	min. max.		
2	EL	30 1.330	25 1.130	-	7
2	S	30 1.330	30 1.330	160	7
3	EL	75 2.000	64 1.700	-	7,5
3	S	75 2.000	75 2.000	160	7,5

Note:

Use relay KFA6 for NF impulse generator and frequency converter KFU8 for HF impulse generator (see pos. 1.514 and 1.515)
 Size 01 – oil meter VZO 8 fitted
 Size 2 – oil meter VZO 20 fitted
 Size 3 – oil meter VZO 25 fitted

1.621 **Throttle, for equalisation of flow resistances at residual oil operation**
 DN32 (for size 1)
 DN50 (for size 2)
 DN65 (for size 3)

1.622 **Pressure gauge** -1 to 9 bar, for oil circulation tank
 1.623 0 - 6 bar ring main
 1.624 Vacuum gauge -1/+5 bar ring main

1.7 Single pipe fittings / Oil leakage alarm

Pump set, single pipe
 (Delivery time must be requested project-related)

1.701	Single station	Eff. flow volume*)	Max. perm. withdraw. quantity	Suction/Press. side counter flanges	Motor	Nom. speed
	Type	l/h	l/h	DN PN	Volt Hz kW	rpm
	BASD 150	155	125	20/20, 16	230/400 50 0.25	910
	BASD 250	260	230	20/20, 16	230/400 50 0.37	1400
	BASD 350	397	367	20/20, 16	230/400 50 0.37	1400
	BASD 550	535	435	20/20, 16	230/400 50 0.37	1400
	BASD 850	846	746	20/20, 16	230/400 50 0.55	2800
	BASD 1150	1140	1040	20/20, 16	230/400 50 0.55	2800
	BASD 1650	1602	1502	20/20, 16	230/400 50 0.55	2800
	BASD 2250	2256	1956	25/25, 16	230/400 50 1.1	2800
	BASD 3150	3168	2868	25/25, 16	230/400 50 1.1	2800
1.702	Twin station					
	ZASD 150	155	125	25/20 16	230/400 50 0.25	910
	ZASD 250	260	230	25/20 16	230/400 50 0.37	1400
	ZASD 350	397	367	25/20 16	230/400 50 0.37	1400
	ZASD 550	535	435	25/20 16	230/400 50 0.37	1400
	ZASD 850	846	746	25/20 16	230/400 50 0.55	2800
	ZASD 1150	1140	1040	25/20 16	230/400 50 0.55	2800
	ZASD 1650	1602	1502	25/20 16	230/400 50 0.55	2800
	ZASD 2250	2256	1956	32/25 16	230/400 50 1.1	2800
	ZASD 3150	3168	2868	32/25 16	230/400 50 1.1	2800

The stated values are valid for one pump!
 *) with Δp=4 bar, v=6 mm²/s

1.703 **Oil leakage alarm with plug housing HMS**

No. Dénomination

1.619 **Pot de circulation avec filtre, compteur avec transmetteur d'impulsions basses fréquences et fin de course de positionnement pour FOD et FOL, également pour installations selon TRD avec raccords à souder**

Grandeur	Fioul	Plage l/h	kg/h	Puissance réchauffage Watt	Contenance fioul dm ³
		min. max.	min. max.		
01	FOD	4 190	3,4 162	-	2,5
2	FOD	30 1.330	25 1.130	-	7
2	FOL	30 1.330	25 1.330	160	7
3	FOD	75 2.000	64 1.700	-	7,5
3	FOL	75 2.000	75 2.000	160	7,5

1.620 **Raccords à brides**

Grandeur	Fioul	Plage l/h	kg/h	Puissance réchauffage Watt	Contenance fioul dm ³
		min. max.	min. max.		
2	FOD	30 1.330	25 1.130	-	7
2	FOL	30 1.330	30 1.330	160	7
3	FOD	75 2.000	64 1.700	-	7,5
3	FOL	75 2.000	75 2.000	160	7,5

Remarque :

Utiliser des relais KFA6 pour émetteurs d'impulsions basse fréquence et convertisseur de fréquence KFU8 pour émetteurs d'impulsions haute fréquence (voir pos. 1.514 et 1.515).
 Grandeur 01 – compteur VZO 8 incorporé
 Grandeur 2 – compteur VZO 20 incorporé
 Grandeur 3 – compteur VZO 25 incorporé

1.621 **Clapet pour compensation du débit en FOL**
 DN32 (pour grandeur 1)
 DN50 (pour grandeur 2)
 DN65 (pour grandeur 3)

1.622 **Manomètre** -1 à +9 bar, pour montage d'un pot de circulation
 1.623 0 - 6 bar boucle de transfert
 1.624 Vacuomètre/Manomètre -1/+5 bar boucle de transfert

1.7 Groupe pompe mono-tube/Détec. de fuite de fioul

Groupe pompe, mono-tube
 (demander le délai de livraison)

1.701	Groupe pompe simple	Débit à l'aspir. *)	Débit max.-prélevé	Pression/Dépress. Contre-bride	Moteur	Vites. nom.
	Type	l/h	l/h	DN PN	Volt Hz kW	1/min
	BASD 150	155	125	20/20, 16	230/400 50 0.25	910
	BASD 250	260	230	20/20, 16	230/400 50 0.37	1400
	BASD 350	397	367	20/20, 16	230/400 50 0.37	1400
	BASD 550	535	435	20/20, 16	230/400 50 0.37	1400
	BASD 850	846	746	20/20, 16	230/400 50 0.55	2800
	BASD 1150	1140	1040	20/20, 16	230/400 50 0.55	2800
	BASD 1650	1602	1502	20/20, 16	230/400 50 0.55	2800
	BASD 2250	2256	1956	25/25, 16	230/400 50 1,1	2800
	BASD 3150	3168	2868	25/25, 16	230/400 50 1,1	2800
1.702	Groupe pompe double					
	ZASD 150	155	125	25/20 16	230/400 50 0,25	910
	ZASD 250	260	230	25/20 16	230/400 50 0,37	1400
	ZASD 350	397	367	25/20 16	230/400 50 0,37	1400
	ZASD 550	535	435	25/20 16	230/400 50 0,37	1400
	ZASD 850	846	746	25/20 16	230/400 50 0,55	2800
	ZASD 1150	1140	1040	25/20 16	230/400 50 0,55	2800
	ZASD 1650	1602	1502	25/20 16	230/400 50 0,55	2800
	ZASD 2250	2256	1956	32/25 16	230/400 50 1,1	2800
	ZASD 3150	3168	2868	32/25 16	230/400 50 1,1	2800

Les valeurs indiquées sont valables pour une pompe !
 *) pour Δp=4 bar, v=6 mm²/s

1.703 **Indicateur fuite de fioul avec connecteur HMS**

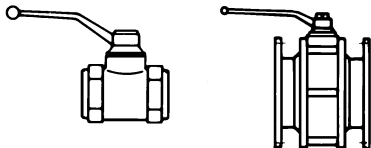

2.101 - 2.105

2.102
2.104

Nr.	Bezeichnung	Bestell-Nr. Order No. N° de commande	Preis EUR (o. MwSt.)
2.	Zubehör Gasbrenner		
2.1	Kugelhähne		
	Ausführung Standard		
2.101	Kugelhahn mit Innengewinde nach DIN EN331, Dichtung Teflon, Gehäuse Messing, max. Betriebsdruck 5 bar		
	Typ DN		
	984-D Rp 1/4	454 657	
	984-D Rp 3/8	454 658	
	984-D Rp 1/2	454 659	
	984-D Rp 3/4	454 660	
	984-D Rp 1	454 661	
	984-D Rp 1 1/4	454 662	
	984-D Rp 1 1/2	454 663	
	984-D Rp 2	454 664	
2.102	Kugelhahn geflanscht nach DIN EN 13774, PN16 max. Betriebsdruck 16 bar, Gehäuse GGG40 Typ KSN 75-B		
	DN 25	151 331 2674 2	
	DN 40	151 331 2675 2	
	DN 50	151 331 2676 2	
	DN 65	151 331 2677 2	
	DN 80	151 331 2678 2	
	DN 100	151 331 2679 2	
	DN 125 *	151 331 2680 2	
	DN 150 *	151 331 2681 2	
	Zum Lieferumfang gehören: Schrauben, Muttern und Dichtung für eine Trennstelle * Hinweise im technischen Arbeitsblatt 7-2.3 Blatt 1 beachten!		
2.103	Kugelhahn mit thermischer Absperrereinrichtung Standardtypen		
	Typ DN PN		
	998 NG-1/2-CE-TAE Rp 1/2 1	454 595	
	998 NG-3/4-CE-TAE Rp 3/4 1	454 596	
	998 NG-1-CE-TAE Rp 1 1	454 597	
	84-1 1/2-CE-TAE Rp 1 1/2 5	454 579	
	84-2-CE-TAE Rp 2 5	454 580	
	Ausführung Klär- und Biogas		
	Ausführung Klär- und Biogas (Dichtung Teflon und Viton PN16) Gehäuse Edelstahl		
	87 E-3/4 Rp 3/4	454 012	
	87 E-1 Rp 1	454 013	
	87 E1 1/2 Rp 1 1/2	454 014	
	87 E-2 Rp 2	454 015	
2.104	Ausführung Klär- und Biogas Kugelhahn geflanscht nach DIN EN 13774, PN16 max. Betriebsdruck 16 bar, Gehäuse GGG40, Typ KSN 75-F		
	DN 25	151 327 2655 2	
	DN 40	151 330 2660 2	
	DN 50	151 330 2661 2	
	DN 65	151 330 2662 2	
	DN 80	151 330 2663 2	
	DN 100	151 330 2664 2	
	DN 125 *	151 330 2665 2	
	DN 150 *	151 330 2666 2	
	Zum Lieferumfang gehören: Schrauben, Muttern und Dichtung für eine Trennstelle * Hinweise im technischen Arbeitsblatt 7-2.3 Blatt 2 beachten!		
2.105	Ausführung Klär- und Biogas (Dichtung Teflon) Gehäuse Edelstahl, mit thermischer Absperrereinrichtung		
	Typ DN PN		
	87-E-1-TAE Rp 1 5	454 634	
	87-E-1 1/2-TAE Rp 1 1/2 5	454 635	
	87-E-2-TAE Rp 2 5	454 636	

No.	Description																										
2.	Gas burner accessories																										
2.1	Ball valves																										
	Standard version																										
2.101	<p>Ball valve with internal thread, to DIN EN331, Teflon seal, brass housing, max. operating pressure 5 bar</p> <table> <tr> <td>Type</td> <td>DN</td> </tr> <tr> <td>84-1/4-CE</td> <td>Rp 1/4</td> </tr> <tr> <td>84-3/8-CE</td> <td>Rp 3/8</td> </tr> <tr> <td>84-1/2-CE</td> <td>Rp 1/2</td> </tr> <tr> <td>84-3/4-CE</td> <td>Rp 3/4</td> </tr> <tr> <td>84-1-CE</td> <td>Rp 1</td> </tr> <tr> <td>84-1 1/4-CE</td> <td>Rp 1 1/4</td> </tr> <tr> <td>84-1 1/2-CE</td> <td>Rp 1 1/2</td> </tr> <tr> <td>84-2-CE</td> <td>Rp 2</td> </tr> </table>	Type	DN	84-1/4-CE	Rp 1/4	84-3/8-CE	Rp 3/8	84-1/2-CE	Rp 1/2	84-3/4-CE	Rp 3/4	84-1-CE	Rp 1	84-1 1/4-CE	Rp 1 1/4	84-1 1/2-CE	Rp 1 1/2	84-2-CE	Rp 2								
Type	DN																										
84-1/4-CE	Rp 1/4																										
84-3/8-CE	Rp 3/8																										
84-1/2-CE	Rp 1/2																										
84-3/4-CE	Rp 3/4																										
84-1-CE	Rp 1																										
84-1 1/4-CE	Rp 1 1/4																										
84-1 1/2-CE	Rp 1 1/2																										
84-2-CE	Rp 2																										
2.102	<p>Ball valve flanged to DIN EN 13774, PN16 max. operating press. 16 bar,</p> <p>DN 25 DN 40 DN 50 DN 65</p> <p>DN 80 DN 100 DN 125 * DN 150 *</p> <p>Included in delivery: screws, nuts and seals for one connection point. * Please observe note in technical worksheet 7-2.3 sheet 1!</p>																										
2.103	<p>Ball valve with thermal shut off device</p> <p>Standard types</p> <table> <tr> <td>Type</td> <td>DN</td> <td>PN</td> </tr> <tr> <td>998 NG-1/2-CE-TAE</td> <td>Rp 1/2</td> <td>1</td> </tr> <tr> <td>998 NG-3/4-CE-TAE</td> <td>Rp 3/4</td> <td>1</td> </tr> <tr> <td>998 NG-1-CE-TAE</td> <td>Rp 1</td> <td>1</td> </tr> <tr> <td>84-1 1/2-CE-TAE</td> <td>Rp 1 1/2</td> <td>5</td> </tr> <tr> <td>84-2-CE-TAE</td> <td>Rp 2</td> <td>5</td> </tr> </table> <p>Sewage and biogas version</p> <p>Sewage and biogas version (Teflon seal and Viton PN16) housing stainless steel</p> <table> <tr> <td>87 E-3/4</td> <td>Rp 3/4</td> </tr> <tr> <td>87 E-1</td> <td>Rp 1</td> </tr> <tr> <td>87 E1 1/2</td> <td>Rp 1 1/2</td> </tr> <tr> <td>87 E-2</td> <td>Rp 2</td> </tr> </table>	Type	DN	PN	998 NG-1/2-CE-TAE	Rp 1/2	1	998 NG-3/4-CE-TAE	Rp 3/4	1	998 NG-1-CE-TAE	Rp 1	1	84-1 1/2-CE-TAE	Rp 1 1/2	5	84-2-CE-TAE	Rp 2	5	87 E-3/4	Rp 3/4	87 E-1	Rp 1	87 E1 1/2	Rp 1 1/2	87 E-2	Rp 2
Type	DN	PN																									
998 NG-1/2-CE-TAE	Rp 1/2	1																									
998 NG-3/4-CE-TAE	Rp 3/4	1																									
998 NG-1-CE-TAE	Rp 1	1																									
84-1 1/2-CE-TAE	Rp 1 1/2	5																									
84-2-CE-TAE	Rp 2	5																									
87 E-3/4	Rp 3/4																										
87 E-1	Rp 1																										
87 E1 1/2	Rp 1 1/2																										
87 E-2	Rp 2																										
2.104	<p>Version sewage and bio gas</p> <p>Ball valve flanged to DIN 13774, PN16 max. oper. press. 16 bar</p> <p>DN 25 DN 40 DN 50 DN 65</p> <p>DN 80 DN 100 DN 125 * DN 150 *</p> <p>Included in delivery are:screws, nuts and seals for one connection point * Please observe note in technical worksheet 7-2.3 sheet 2!</p>																										
2.105	<p>Version sewage and bio gas (Teflon seal) housing stainless steel, with thermal shut off device</p> <table> <tr> <td>Type</td> <td>DN</td> <td>PN</td> </tr> <tr> <td>87-E-1-TAE</td> <td>Rp 1</td> <td>5</td> </tr> <tr> <td>87-E-1 1/2-TAE</td> <td>Rp 1 1/2</td> <td>5</td> </tr> <tr> <td>87-E-2-TAE</td> <td>Rp 2</td> <td>5</td> </tr> </table>	Type	DN	PN	87-E-1-TAE	Rp 1	5	87-E-1 1/2-TAE	Rp 1 1/2	5	87-E-2-TAE	Rp 2	5														
Type	DN	PN																									
87-E-1-TAE	Rp 1	5																									
87-E-1 1/2-TAE	Rp 1 1/2	5																									
87-E-2-TAE	Rp 2	5																									

No.	Dénomination																										
2.	Accessoires brûleur gaz																										
2.1	Robinets à bille																										
	Exécution standard																										
2.101	<p>Robinet à bille avec filetage int. selon DIN EN331, joint Teflon, pression de service max. 5 bar</p> <table> <tr> <td>Type</td> <td>DN</td> </tr> <tr> <td>84-1/4-CE</td> <td>Rp 1/4</td> </tr> <tr> <td>84-3/8-CE</td> <td>Rp 3/8</td> </tr> <tr> <td>84-1/2-CE</td> <td>Rp 1/2</td> </tr> <tr> <td>84-3/4-CE</td> <td>Rp 3/4</td> </tr> <tr> <td>84-1-CE</td> <td>Rp 1</td> </tr> <tr> <td>84-1 1/4-CE</td> <td>Rp 1 1/4</td> </tr> <tr> <td>84-1 1/2-CE</td> <td>Rp 1 1/2</td> </tr> <tr> <td>84-2-CE</td> <td>Rp 2</td> </tr> </table>	Type	DN	84-1/4-CE	Rp 1/4	84-3/8-CE	Rp 3/8	84-1/2-CE	Rp 1/2	84-3/4-CE	Rp 3/4	84-1-CE	Rp 1	84-1 1/4-CE	Rp 1 1/4	84-1 1/2-CE	Rp 1 1/2	84-2-CE	Rp 2								
Type	DN																										
84-1/4-CE	Rp 1/4																										
84-3/8-CE	Rp 3/8																										
84-1/2-CE	Rp 1/2																										
84-3/4-CE	Rp 3/4																										
84-1-CE	Rp 1																										
84-1 1/4-CE	Rp 1 1/4																										
84-1 1/2-CE	Rp 1 1/2																										
84-2-CE	Rp 2																										
2.102	<p>Robinet à bille à brides selon DIN EN 13774, PN16 pression de service max. 16 bar,corps GGG40 type KSN 75-B</p> <p>DN 25 DN 40 DN 50 DN 65</p> <p>DN 80 DN 100 DN 125 * DN 150 *</p> <p>La fourniture comprend : vis, écrous et joints pour une liaison * Tenir compte des remarques dans la fiche technique 7-2.3 feuil. 1 !</p>																										
2.103	<p>Robinet à bille avec sécurité thermique</p> <p>Types standards</p> <table> <tr> <td>Type</td> <td>DN</td> <td>PN</td> </tr> <tr> <td>998 NG-1/2-CE-TAE</td> <td>Rp 1/2</td> <td>1</td> </tr> <tr> <td>998 NG-3/4-CE-TAE</td> <td>Rp 3/4</td> <td>1</td> </tr> <tr> <td>998 NG-1-CE-TAE</td> <td>Rp 1</td> <td>1</td> </tr> <tr> <td>84-1 1/2-CE-TAE</td> <td>Rp 1 1/2</td> <td>5</td> </tr> <tr> <td>84-2-CE-TAE</td> <td>Rp 2</td> <td>5</td> </tr> </table> <p>Exécution biogaz</p> <p>Exécution biogaz (joint Téflon et Viton PN16) corps inox</p> <table> <tr> <td>87 E-3/4</td> <td>Rp 3/4</td> </tr> <tr> <td>87 E-1</td> <td>Rp 1</td> </tr> <tr> <td>87 E1 1/2</td> <td>Rp 1 1/2</td> </tr> <tr> <td>87 E-2</td> <td>Rp 2</td> </tr> </table>	Type	DN	PN	998 NG-1/2-CE-TAE	Rp 1/2	1	998 NG-3/4-CE-TAE	Rp 3/4	1	998 NG-1-CE-TAE	Rp 1	1	84-1 1/2-CE-TAE	Rp 1 1/2	5	84-2-CE-TAE	Rp 2	5	87 E-3/4	Rp 3/4	87 E-1	Rp 1	87 E1 1/2	Rp 1 1/2	87 E-2	Rp 2
Type	DN	PN																									
998 NG-1/2-CE-TAE	Rp 1/2	1																									
998 NG-3/4-CE-TAE	Rp 3/4	1																									
998 NG-1-CE-TAE	Rp 1	1																									
84-1 1/2-CE-TAE	Rp 1 1/2	5																									
84-2-CE-TAE	Rp 2	5																									
87 E-3/4	Rp 3/4																										
87 E-1	Rp 1																										
87 E1 1/2	Rp 1 1/2																										
87 E-2	Rp 2																										
2.104	<p>Exécution biogaz</p> <p>Robinet à bille à brides selon DIN 13774, PN16 pression de service max. 16 bar, corps GGG40, type KSN 75-F</p> <p>DN 25 DN 40 DN 50 DN 65</p> <p>DN 80 DN 100 DN 125 * DN 150 *</p> <p>La fourniture comprend : vis, écrous et joints pour une liaison * Tenir compte des remarques dans la fiche technique 7-2.3 feuil. 2 !</p>																										
2.105	<p>Exécution biogaz (joint Téflon) corps inox, avec sécurité thermique</p> <table> <tr> <td>Type</td> <td>DN</td> <td>PN</td> </tr> <tr> <td>87-E-1-TAE</td> <td>Rp 1</td> <td>5</td> </tr> <tr> <td>87-E-1 1/2-TAE</td> <td>Rp 1 1/2</td> <td>5</td> </tr> <tr> <td>87-E-2-TAE</td> <td>Rp 2</td> <td>5</td> </tr> </table>	Type	DN	PN	87-E-1-TAE	Rp 1	5	87-E-1 1/2-TAE	Rp 1 1/2	5	87-E-2-TAE	Rp 2	5														
Type	DN	PN																									
87-E-1-TAE	Rp 1	5																									
87-E-1 1/2-TAE	Rp 1 1/2	5																									
87-E-2-TAE	Rp 2	5																									

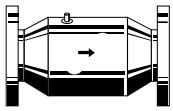

2.201
2.202

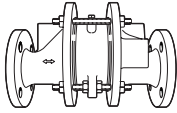

2.203

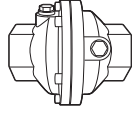

2.204

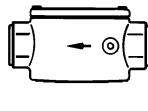

2.301

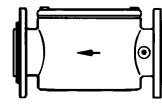

2.302

Nr.	Bezeichnung	Bestell-Nr. Order No. N° de commande	Preis EUR (o. MwSt.)
2.2	Thermische Absperrvorrichtung (siehe hierzu Technisches Arbeitsblatt Dr.-Nr. 7-2.2)		
2.201	Standardtypen		
	Typ DN		
	GT 40 FFM 40	151 331 2640 2	
	GT 50 FFM 50	151 331 2641 2	
	GT 65 FFM 65	151 331 2642 2	
	GT 80 FFM 80	151 331 2643 2	
	GT100 FFM 100	151 331 2644 2	
	GT125 FFM 125	151 331 2645 2	
	GT150 FFM 150	151 331 2646 2	
2.202	Ausführung Klär- und Biogas		
	Typ DN		
	GT 40 FFM 40	151 331 2647 2	
	GT 50 FFM 50	151 331 2648 2	
	GT 65 FFM 65	151 331 2649 2	
	GT 80 FFM 80	151 331 2650 2	
	GT100 FFM 100	151 331 2651 2	
	Dichtungs-Set für thermische Absperrvorrichtung (bestehend aus 2 HTB-Flanschdichtungen)		
	DN 40	151 331 2686 2	
	DN 50	151 331 2687 2	
	DN 65	151 331 2688 2	
	DN 80	151 331 2689 2	
	DN 100	151 331 2690 2	
	DN 125	151 331 2691 2	
	DN 150	151 331 2692 2	
	Flammenrückschlagsicherung		
2.203	Flammenrückschlagsicherung geflanscht mit Verbindungsteilen		
	FA-E40 DN 40	151 351 2674 2	
	FA-E50 DN 50	151 351 2675 2	
	FA-E65 DN 65	151 351 2676 2	
	FA-E80 DN 80	151 351 2677 2	
	FA-E100 DN 100	151 351 2678 2	
	FA-E125 DN 125	151 351 2679 2	
	FA-E150 DN 150	151 351 2680 2	
2.204	Flammenrückschlagsicherung geschraubt		
	FA-G20 G3/4"	640 530	
	FA-G25 G1"	640 531	
	FA-G40 G1 1/2"	640 539	
	FA-G50 G2"	640 540	
2.3	Gasfilter		
2.301	Gasfilter mit Innengewinde max. Betriebsdruck 0,5 bar		
	WF 503/1 RP 3/8	151 223 4024 0	
	WF 505/1 RP 1/2	151 223 4012 0	
	WF 507/1 RP 3/4	151 223 4013 0	
	WF 510/1 RP 1	151 223 4014 0	
	WF 515/1 RP 1 1/2	151 223 4015 0	
	WF 520/1 RP 2"	151 223 4016 0	
2.302	Gasfilter geflanscht DIN 2633 PN16 max. Betriebsdruck in bar		
	WF 3025/1 25 5	151 330 2624 2	
	WF 3040/1 40 5	151 328 2680 2	
	WF 3050/1 50 5	151 327 2650 2	
	WF 3065/1 65 5	151 327 2651 2	
	WF 3080/1 80 5	151 329 2692 2	
	WF 3100/1 100 5	151 327 2653 2	
	WF 3125/1 125 2	151 327 2654 2	
	WF 3150/1 150 2	151 329 2664 2	
	Filter Set DN 125 bis Pe max. 6 bar auch für Klär- und Biogas geeignet (Typ GF125MF)	151 327 2605 2	
	Filter Set DN 150 bis Pe max. 6 bar auch für Klär- und Biogas geeignet (Typ GF150MF)	151 329 2604 2	
	Zum Lieferumfang gehören: Schrauben, Muttern und Dichtung für eine Trennstelle.		

No.	Description																								
2.2	Thermal shut off device (see Technical working sheet print No. 7-2.2)																								
2.201	Standard types <table border="0"> <tr> <td>Type</td> <td>DN</td> </tr> <tr> <td>GT 40 FFM</td> <td>40</td> </tr> <tr> <td>GT 50 FFM</td> <td>50</td> </tr> <tr> <td>GT 65 FFM</td> <td>65</td> </tr> <tr> <td>GT 80 FFM</td> <td>80</td> </tr> <tr> <td>GT100 FFM</td> <td>100</td> </tr> <tr> <td>GT125 FFM</td> <td>125</td> </tr> <tr> <td>GT150 FFM</td> <td>150</td> </tr> </table>	Type	DN	GT 40 FFM	40	GT 50 FFM	50	GT 65 FFM	65	GT 80 FFM	80	GT100 FFM	100	GT125 FFM	125	GT150 FFM	150								
Type	DN																								
GT 40 FFM	40																								
GT 50 FFM	50																								
GT 65 FFM	65																								
GT 80 FFM	80																								
GT100 FFM	100																								
GT125 FFM	125																								
GT150 FFM	150																								
2.202	Version sewage and biogas <table border="0"> <tr> <td>Type</td> <td>DN</td> </tr> <tr> <td>GT 40 FFM</td> <td>40</td> </tr> <tr> <td>GT 50 FFM</td> <td>50</td> </tr> <tr> <td>GT 65 FFM</td> <td>65</td> </tr> <tr> <td>GT 80 FFM</td> <td>80</td> </tr> <tr> <td>GT100 FFM</td> <td>100</td> </tr> </table> <p>Gasket set for thermal shut off device (consisting of 2 HTB flange gaskets) DN 40 DN 50 DN 65 DN 80 DN 100 DN 125 DN 150</p> <p>Flame flashback protection</p>	Type	DN	GT 40 FFM	40	GT 50 FFM	50	GT 65 FFM	65	GT 80 FFM	80	GT100 FFM	100												
Type	DN																								
GT 40 FFM	40																								
GT 50 FFM	50																								
GT 65 FFM	65																								
GT 80 FFM	80																								
GT100 FFM	100																								
2.203	Flame flashback protection flanged with connection parts <table border="0"> <tr> <td>FA-E40</td> <td>DN 40</td> </tr> <tr> <td>FA-E50</td> <td>DN 50</td> </tr> <tr> <td>FA-E65</td> <td>DN 65</td> </tr> <tr> <td>FA-E80</td> <td>DN 80</td> </tr> <tr> <td>FA-E100</td> <td>DN 100</td> </tr> <tr> <td>FA-E125</td> <td>DN 125</td> </tr> <tr> <td>FA-E150</td> <td>DN 150</td> </tr> </table>	FA-E40	DN 40	FA-E50	DN 50	FA-E65	DN 65	FA-E80	DN 80	FA-E100	DN 100	FA-E125	DN 125	FA-E150	DN 150										
FA-E40	DN 40																								
FA-E50	DN 50																								
FA-E65	DN 65																								
FA-E80	DN 80																								
FA-E100	DN 100																								
FA-E125	DN 125																								
FA-E150	DN 150																								
2.204	Flame flashback protection screwed FA-G20 G3/4" FA-G25 G1" FA-G40 G1 1/2" FA-G50 G2"																								
2.3	Gas filters																								
2.301	Gas filter with internal thread max. operating pressure 0.5 bar <table border="0"> <tr> <td>WF 503/1</td> <td>RP 3/8</td> </tr> <tr> <td>WF 505/1</td> <td>RP 1/2</td> </tr> <tr> <td>WF 507/1</td> <td>RP 3/4</td> </tr> <tr> <td>WF 510/1</td> <td>RP 1</td> </tr> <tr> <td>WF 515/1</td> <td>RP 1 1/2</td> </tr> <tr> <td>WF 520/1</td> <td>RP 2"</td> </tr> </table>	WF 503/1	RP 3/8	WF 505/1	RP 1/2	WF 507/1	RP 3/4	WF 510/1	RP 1	WF 515/1	RP 1 1/2	WF 520/1	RP 2"												
WF 503/1	RP 3/8																								
WF 505/1	RP 1/2																								
WF 507/1	RP 3/4																								
WF 510/1	RP 1																								
WF 515/1	RP 1 1/2																								
WF 520/1	RP 2"																								
2.302	Gas filter flanged DIN 2633 PN16, max. operating pressure <table border="0"> <tr> <td>WF 3025/1</td> <td>25</td> <td>5</td> </tr> <tr> <td>WF 3040/1</td> <td>40</td> <td>5</td> </tr> <tr> <td>WF 3050/1</td> <td>50</td> <td>5</td> </tr> <tr> <td>WF 3065/1</td> <td>65</td> <td>5</td> </tr> <tr> <td>WF 3080/1</td> <td>80</td> <td>5</td> </tr> <tr> <td>WF 3100/1</td> <td>100</td> <td>5</td> </tr> <tr> <td>WF 3125/1</td> <td>125</td> <td>2</td> </tr> <tr> <td>WF 3150/1</td> <td>150</td> <td>2</td> </tr> </table> <p>Filter set DN 125 to Pe max. 6 bar also suitable for sewage and biogas (type GF125MF) Filter set DN 150 to Pe max. 6 bar also suitable for sewage and biogas (type GF150MF)</p> <p>Included in delivery: Screws, nuts and seals for one connection point.</p>	WF 3025/1	25	5	WF 3040/1	40	5	WF 3050/1	50	5	WF 3065/1	65	5	WF 3080/1	80	5	WF 3100/1	100	5	WF 3125/1	125	2	WF 3150/1	150	2
WF 3025/1	25	5																							
WF 3040/1	40	5																							
WF 3050/1	50	5																							
WF 3065/1	65	5																							
WF 3080/1	80	5																							
WF 3100/1	100	5																							
WF 3125/1	125	2																							
WF 3150/1	150	2																							

No.	Dénomination																								
2.2	Soupape de sécurité therm. (voir fiches techn. n° d'impr. 7-2.2)																								
2.201	Types standards <table border="0"> <tr> <td>Type</td> <td>DN</td> </tr> <tr> <td>GT 40 FFM</td> <td>40</td> </tr> <tr> <td>GT 50 FFM</td> <td>50</td> </tr> <tr> <td>GT 65 FFM</td> <td>65</td> </tr> <tr> <td>GT 80 FFM</td> <td>80</td> </tr> <tr> <td>GT100 FFM</td> <td>100</td> </tr> <tr> <td>GT125 FFM</td> <td>125</td> </tr> <tr> <td>GT150 FFM</td> <td>150</td> </tr> </table>	Type	DN	GT 40 FFM	40	GT 50 FFM	50	GT 65 FFM	65	GT 80 FFM	80	GT100 FFM	100	GT125 FFM	125	GT150 FFM	150								
Type	DN																								
GT 40 FFM	40																								
GT 50 FFM	50																								
GT 65 FFM	65																								
GT 80 FFM	80																								
GT100 FFM	100																								
GT125 FFM	125																								
GT150 FFM	150																								
2.202	Exécution biogaz <table border="0"> <tr> <td>Type</td> <td>DN</td> </tr> <tr> <td>GT 40 FFM</td> <td>40</td> </tr> <tr> <td>GT 50 FFM</td> <td>50</td> </tr> <tr> <td>GT 65 FFM</td> <td>65</td> </tr> <tr> <td>GT 80 FFM</td> <td>80</td> </tr> <tr> <td>GT100 FFM</td> <td>100</td> </tr> </table> <p>Ensemble d'étanchéité pour vanne TAS (composé de 2 joints HTB pour bride) DN 40 DN 50 DN 65 DN 80 DN 100 DN 125 DN 150</p> <p>Sécurité anti-retour de flamme</p>	Type	DN	GT 40 FFM	40	GT 50 FFM	50	GT 65 FFM	65	GT 80 FFM	80	GT100 FFM	100												
Type	DN																								
GT 40 FFM	40																								
GT 50 FFM	50																								
GT 65 FFM	65																								
GT 80 FFM	80																								
GT100 FFM	100																								
2.203	Sécurité anti-retour de flamme à brides avec éléments de liaison <table border="0"> <tr> <td>FA-E40</td> <td>DN 40</td> </tr> <tr> <td>FA-E50</td> <td>DN 50</td> </tr> <tr> <td>FA-E65</td> <td>DN 65</td> </tr> <tr> <td>FA-E80</td> <td>DN 80</td> </tr> <tr> <td>FA-E100</td> <td>DN 100</td> </tr> <tr> <td>FA-E125</td> <td>DN 125</td> </tr> <tr> <td>FA-E150</td> <td>DN 150</td> </tr> </table>	FA-E40	DN 40	FA-E50	DN 50	FA-E65	DN 65	FA-E80	DN 80	FA-E100	DN 100	FA-E125	DN 125	FA-E150	DN 150										
FA-E40	DN 40																								
FA-E50	DN 50																								
FA-E65	DN 65																								
FA-E80	DN 80																								
FA-E100	DN 100																								
FA-E125	DN 125																								
FA-E150	DN 150																								
2.204	Sécurité anti-retour de flamme à visser FA-G20 G3/4" FA-G25 G1" FA-G40 G1 1/2" FA-G50 G2"																								
2.3	Filtres gaz																								
2.301	Filtre gaz avec filetage int. pression de service max. 0,5 bar <table border="0"> <tr> <td>WF 503/1</td> <td>RP 3/8</td> </tr> <tr> <td>WF 505/1</td> <td>RP 1/2</td> </tr> <tr> <td>WF 507/1</td> <td>RP 3/4</td> </tr> <tr> <td>WF 510/1</td> <td>RP 1</td> </tr> <tr> <td>WF 515/1</td> <td>RP 1 1/2</td> </tr> <tr> <td>WF 520/1</td> <td>RP 2"</td> </tr> </table>	WF 503/1	RP 3/8	WF 505/1	RP 1/2	WF 507/1	RP 3/4	WF 510/1	RP 1	WF 515/1	RP 1 1/2	WF 520/1	RP 2"												
WF 503/1	RP 3/8																								
WF 505/1	RP 1/2																								
WF 507/1	RP 3/4																								
WF 510/1	RP 1																								
WF 515/1	RP 1 1/2																								
WF 520/1	RP 2"																								
2.302	Filtre gaz à brides DIN 2633 PN16 Pression de service max. en bar <table border="0"> <tr> <td>WF 3025/1</td> <td>25</td> <td>5</td> </tr> <tr> <td>WF 3040/1</td> <td>40</td> <td>5</td> </tr> <tr> <td>WF 3050/1</td> <td>50</td> <td>5</td> </tr> <tr> <td>WF 3065/1</td> <td>65</td> <td>5</td> </tr> <tr> <td>WF 3080/1</td> <td>80</td> <td>5</td> </tr> <tr> <td>WF 3100/1</td> <td>100</td> <td>5</td> </tr> <tr> <td>WF 3125/1</td> <td>125</td> <td>2</td> </tr> <tr> <td>WF 3150/1</td> <td>150</td> <td>2</td> </tr> </table> <p>Filtres DN 125 à Pe max. 6 bar adapté pour biogaz (type GF125MF) Filtres DN 150 à Pe max. 6 bar adapté pour biogaz (type GF150MF)</p> <p>La fourniture comprend : vis, écrous et joints pour une liaison.</p>	WF 3025/1	25	5	WF 3040/1	40	5	WF 3050/1	50	5	WF 3065/1	65	5	WF 3080/1	80	5	WF 3100/1	100	5	WF 3125/1	125	2	WF 3150/1	150	2
WF 3025/1	25	5																							
WF 3040/1	40	5																							
WF 3050/1	50	5																							
WF 3065/1	65	5																							
WF 3080/1	80	5																							
WF 3100/1	100	5																							
WF 3125/1	125	2																							
WF 3150/1	150	2																							

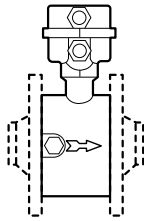
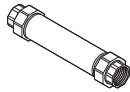
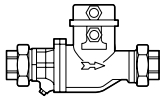

2.401

2.402

2.403

Nr.	Bezeichnung	Bestell-Nr. Order No. N° de commande	Preis EUR (o. MwSt.)
2.303	Filtereinsatz für Gasfilter (ohne Bild) WF 503/1 - WF 505/1 WF 507/1 WF 510/1 - WF 3025/1 WF 515/1 WF 520/1 WF 3040/1 WF 3050/1 WF 3065/1 WF 3080/1 WF 3100/1 WF 3125/1 WF 3150/1	151 224 4007 2 151 224 4008 2 151 224 4009 2 151 224 4010 2 151 224 4011 2 151 224 4012 2 151 224 4013 2 151 224 4014 2 151 224 4015 2 151 224 4016 2 151 224 4017 2 151 224 4018 2	
	Filtereinsatz für DN125 m. Pe max. 6 bar Typ KIT-GF125MF für Filter Typ GF125MF-4040-C-AM	493 332	
	Filtereinsatz für DN150 m. Pe max. 6 bar Typ KIT-GF150MF für Filter Typ GF150MF-4848-C-AM (bestehend aus: Einsatz und Dichtung)	493 333	
2.304	O-Ring für Gasfilter für Filter WF 503/1 - WF 505/1 WF 507/1 WF 510/1 WF 3025/1 WF 515/1 - WF 3040/1 WF 520/1 - WF 3050/1 WF 3065/1 WF 3080/1 WF 3100/1 WF 3125/1 WF 3150/1	Abmessung 58 x 2 72 x 2 90 x 3 100 x 3 140 x 3 160 x 3 156 x 3 200 x 3 235 x 5 290 x 5 330 x 5	445 048 445 049 445 059 445 102 445 051 445 053 445 052 445 054 445 090 445 072 445 073
2.305	Gasfilter für Drücke größer 4 bar Typ Betriebsdruck max. 25/20/16 16 50/21/16 16 80/20/16 16 Zum Lieferumfang gehören: Schrauben, Muttern und Dichtung für eine Trennstelle	151 330 2617 2 151 327 2606 2 151 329 2663 2	
	Filtereinsatz-Set inkl. O-Ring für Gasfilter größer 5 bar, max. Betriebsdruck 16 bar Typ 25/20/16 50/21/16 80/20/16	151 329 2605 2 151 329 2606 2 151 329 2607 2	
2.4	Gaszähler (für Erdgas E, LL und Flüssiggas, nicht für Klärgas)		
2.401	Gaszähler , Ferngeber NF, HF mit Verbindungsteilen und Dichtungen Type Durchsatz Bm³ QA 10/GI 1,6 - 16 G1/PN4 QA 16/GI 2,0 - 25 G1/PN4 QA 25/GI 2,5 - 40 G1/PN4 QA 40/GI 3,3 - 65 G1/PN4	454 561 454 562 454 563 454 564	
2.402	Passstück für Gaszähler QA 10-40 R1, Länge 240 mm	454 910	
	Zwischenbauweise mit Verbindungsteilen und 2 Dichtringen		
2.403	QA65/ZI 6,0 - 100 DN50/PN4	151 331 2660 2	
2.404	QA100/ZI 10,0 - 160 DN80/PN4	151 331 2661 2	
	QA160/ZI 13,0 - 250 DN80/PN4	151 331 2662 2	
2.405	QA250/ZI 20,0 - 400 DN100/PN4	151 331 2663 2	
	QA400/ZI 32,0 - 650 DN100/PN4	151 331 2664 2	
2.406	QA400/ZI 32,0 - 650 DN150/PN4	151 331 2665 2	
	QA650/ZI 50,0 - 1000 DN150/PN4	151 331 2666 2	
	QA1000/ZI 80,0 - 1600 DN150/PN4	151 331 2667 2	
	Ein- bzw. Auslaufstrecke		
2.407	Doppelnippel , R1, Länge 80 mm	139 000 2639 7	
2.408	Zwischenflansch DN 50 Länge 150 mm DN 80 Länge 240 mm DN 100 Länge 300 mm DN 150 Länge 450 mm Relais und Frequenzstromumsetzer siehe Pos. 1.514 und 1.515	151 330 2626 2 151 330 2629 2 151 330 2627 2 151 330 2643 2	

No.	Description	No.	Dénomination																																																
2.303	<p>Filter elements for gas filters (without picture) WF 503/1 - WF 505/1 WF 507/1 WF 510/1 - WF 3025/1 WF 515/1 WF 520/1 WF 3040/1 WF 3050/1 WF 3065/1 WF 3080/1 WF 3100/1 WF 3125/1 WF 3150/1</p> <p>Filter insert for DN125 w. Pe max. 6 bar type KIT-GF125MF for Filter type GF125MF-4040-C-AM Filter insert for DN150 w. Pe max. 6 bar type KIT-GF150MF for filter type GF150MF-4848-C-AM (consisting of: insert and gasket)</p>	2.303	<p>Cartouche filtrante pour filtre (sans photo) WF 503/1 - WF 505/1 WF 507/1 WF 510/1 - WF 3025/1 WF 515/1 WF 520/1 WF 3040/1 WF 3050/1 WF 3065/1 WF 3080/1 WF 3100/1 WF 3125/1 WF 3150/1</p> <p>Cartouche filtrante pour DN 125 m. Pe max. 6 bar type KIT-GF125 MF pour filtres types GF125MF-4040-C-AM Cartouche filtrante pour DN 150 m. Pe max. 6 bar type KIT-GF150MF pour filtre type GF150MF-4848-C-AM (composé de : cartouche + joint)</p>																																																
2.304	<p>O ring for gas filters</p> <table border="1"> <thead> <tr> <th>For filter</th> <th>Dimensions</th> </tr> </thead> <tbody> <tr><td>WF 503/1 - WF 505/1</td><td>58 x 2</td></tr> <tr><td>WF 507/1</td><td>72 x 2</td></tr> <tr><td>WF 510/1</td><td>90 x 3</td></tr> <tr><td>WF 3025/1</td><td>100 x 3</td></tr> <tr><td>WF 515/1 - WF 3040/1</td><td>140 x 3</td></tr> <tr><td>WF 520/1 - WF 3050/1</td><td>160 x 3</td></tr> <tr><td>WF 3065/1</td><td>156 x 3</td></tr> <tr><td>WF 3080/1</td><td>200 x 3</td></tr> <tr><td>WF 3100/1</td><td>235 x 5</td></tr> <tr><td>WF 3125/1</td><td>290 x 5</td></tr> <tr><td>WF 3150/1</td><td>330 x 5</td></tr> </tbody> </table>	For filter	Dimensions	WF 503/1 - WF 505/1	58 x 2	WF 507/1	72 x 2	WF 510/1	90 x 3	WF 3025/1	100 x 3	WF 515/1 - WF 3040/1	140 x 3	WF 520/1 - WF 3050/1	160 x 3	WF 3065/1	156 x 3	WF 3080/1	200 x 3	WF 3100/1	235 x 5	WF 3125/1	290 x 5	WF 3150/1	330 x 5	2.304	<p>Joint torique pour filtre gaz</p> <table border="1"> <thead> <tr> <th>pour filtre</th> <th>Dimensions</th> </tr> </thead> <tbody> <tr><td>WF 503/1 - WF 505/1</td><td>58 x 2</td></tr> <tr><td>WF 507/1</td><td>72 x 2</td></tr> <tr><td>WF 510/1</td><td>90 x 3</td></tr> <tr><td>WF 3025/1</td><td>100 x 3</td></tr> <tr><td>WF 515/1 - WF 3040/1</td><td>140 x 3</td></tr> <tr><td>WF 520/1 - WF 3050/1</td><td>160 x 3</td></tr> <tr><td>WF 3065/1</td><td>156 x 3</td></tr> <tr><td>WF 3080/1</td><td>200 x 3</td></tr> <tr><td>WF 3100/1</td><td>235 x 5</td></tr> <tr><td>WF 3125/1</td><td>290 x 5</td></tr> <tr><td>WF 3150/1</td><td>330 x 5</td></tr> </tbody> </table>	pour filtre	Dimensions	WF 503/1 - WF 505/1	58 x 2	WF 507/1	72 x 2	WF 510/1	90 x 3	WF 3025/1	100 x 3	WF 515/1 - WF 3040/1	140 x 3	WF 520/1 - WF 3050/1	160 x 3	WF 3065/1	156 x 3	WF 3080/1	200 x 3	WF 3100/1	235 x 5	WF 3125/1	290 x 5	WF 3150/1	330 x 5
For filter	Dimensions																																																		
WF 503/1 - WF 505/1	58 x 2																																																		
WF 507/1	72 x 2																																																		
WF 510/1	90 x 3																																																		
WF 3025/1	100 x 3																																																		
WF 515/1 - WF 3040/1	140 x 3																																																		
WF 520/1 - WF 3050/1	160 x 3																																																		
WF 3065/1	156 x 3																																																		
WF 3080/1	200 x 3																																																		
WF 3100/1	235 x 5																																																		
WF 3125/1	290 x 5																																																		
WF 3150/1	330 x 5																																																		
pour filtre	Dimensions																																																		
WF 503/1 - WF 505/1	58 x 2																																																		
WF 507/1	72 x 2																																																		
WF 510/1	90 x 3																																																		
WF 3025/1	100 x 3																																																		
WF 515/1 - WF 3040/1	140 x 3																																																		
WF 520/1 - WF 3050/1	160 x 3																																																		
WF 3065/1	156 x 3																																																		
WF 3080/1	200 x 3																																																		
WF 3100/1	235 x 5																																																		
WF 3125/1	290 x 5																																																		
WF 3150/1	330 x 5																																																		
2.305	<p>Gas filter for pressures above 4 bar</p> <table border="1"> <thead> <tr> <th>Type</th> <th>Max. operating pressure</th> </tr> </thead> <tbody> <tr><td>25/20/16</td><td>16</td></tr> <tr><td>50/21/16</td><td>16</td></tr> <tr><td>80/20/16</td><td>16</td></tr> </tbody> </table> <p>Included in delivery: Screws, nuts and seals for one connection point</p> <p>Filter elements for gas filters above 5 bar, max. operating pressure 16 bar Type 25/20/16 50/21/16 80/20/16</p>	Type	Max. operating pressure	25/20/16	16	50/21/16	16	80/20/16	16	2.305	<p>Filtre gaz pour pressions supérieures à 4 bar</p> <table border="1"> <thead> <tr> <th>Type</th> <th>Pression de service max.</th> </tr> </thead> <tbody> <tr><td>25/20/16</td><td>16</td></tr> <tr><td>50/21/16</td><td>16</td></tr> <tr><td>80/20/16</td><td>16</td></tr> </tbody> </table> <p>La fourniture comprend : Vis, écrous et joints pour une liaison.</p> <p>Cartouche filtrante pour taille de filtre sup. à 5 bar, pression de service max. 16 bar Type 25/20/16 50/21/16 80/20/16</p>	Type	Pression de service max.	25/20/16	16	50/21/16	16	80/20/16	16																																
Type	Max. operating pressure																																																		
25/20/16	16																																																		
50/21/16	16																																																		
80/20/16	16																																																		
Type	Pression de service max.																																																		
25/20/16	16																																																		
50/21/16	16																																																		
80/20/16	16																																																		
2.4	Gas meters (for Natural Gas E, LL and LPG, not for sewage gas)	2.4	Filtre gaz (pour gaz naturel Ei, Es et GPL, pas pour du biogaz)																																																
2.401	<p>Gas meter, transmitter NF, HF with connection parts and seals</p> <table border="1"> <thead> <tr> <th>Type</th> <th>Throughput m³</th> <th></th> </tr> </thead> <tbody> <tr><td>QA 10/GI</td><td>1.6 - 16</td><td>G1/PN4</td></tr> <tr><td>QA 16/GI</td><td>2.0 - 25</td><td>G1/PN4</td></tr> <tr><td>QA 25/GI</td><td>2.5 - 40</td><td>G1/PN4</td></tr> <tr><td>QA 40/GI</td><td>3.3 - 65</td><td>G1/PN4</td></tr> </tbody> </table>	Type	Throughput m ³		QA 10/GI	1.6 - 16	G1/PN4	QA 16/GI	2.0 - 25	G1/PN4	QA 25/GI	2.5 - 40	G1/PN4	QA 40/GI	3.3 - 65	G1/PN4	2.401	<p>Compteur gaz, transmetteurs basses/hautes fréquences avec éléments de liaison et joints</p> <table border="1"> <thead> <tr> <th>Type</th> <th>Débit m³</th> <th></th> </tr> </thead> <tbody> <tr><td>QA 10/GI</td><td>1,6 - 16</td><td>G1/PN4</td></tr> <tr><td>QA 16/GI</td><td>2,0 - 25</td><td>G1/PN4</td></tr> <tr><td>QA 25/GI</td><td>2,5 - 40</td><td>G1/PN4</td></tr> <tr><td>QA 40/GI</td><td>3,3 - 65</td><td>G1/PN4</td></tr> </tbody> </table>	Type	Débit m ³		QA 10/GI	1,6 - 16	G1/PN4	QA 16/GI	2,0 - 25	G1/PN4	QA 25/GI	2,5 - 40	G1/PN4	QA 40/GI	3,3 - 65	G1/PN4																		
Type	Throughput m ³																																																		
QA 10/GI	1.6 - 16	G1/PN4																																																	
QA 16/GI	2.0 - 25	G1/PN4																																																	
QA 25/GI	2.5 - 40	G1/PN4																																																	
QA 40/GI	3.3 - 65	G1/PN4																																																	
Type	Débit m ³																																																		
QA 10/GI	1,6 - 16	G1/PN4																																																	
QA 16/GI	2,0 - 25	G1/PN4																																																	
QA 25/GI	2,5 - 40	G1/PN4																																																	
QA 40/GI	3,3 - 65	G1/PN4																																																	
2.402	<p>Replacement pipe section for gas meter QA 10-40 R1, Length 240 mm</p> <p>Intermediate installation with connection parts and 2 gaskets</p>	2.402	<p>Manchette pour compteur gaz QA 10-40 R1, Longueur 240 mm</p> <p>Montage intermédiaire avec raccords et 2 joints</p>																																																
2.403	QA65/ZI 6,0 - 100 DN50/PN4	2.403	QA65/ZI 6,0 - 100 DN50/PN4																																																
2.404	QA100/ZI 10,0 - 160 DN80/PN4	2.404	QA100/ZI 10,0 - 160 DN80/PN4																																																
	QA160/ZI 13,0 - 250 DN80/PN4		QA160/ZI 13,0 - 250 DN80/PN4																																																
2.405	QA250/ZI 20,0 - 400 DN100/PN4	2.405	QA250/ZI 20,0 - 400 DN100/PN4																																																
	QA400/ZI 32,0 - 650 DN100/PN4		QA400/ZI 32,0 - 650 DN100/PN4																																																
2.406	QA400/ZI 32,0 - 650 DN150/PN4	2.406	QA400/ZI 32,0 - 650 DN150/PN4																																																
	QA650/ZI 50,0 - 1000 DN150/PN4		QA650/ZI 50,0 - 1000 DN150/PN4																																																
	QA1000/ZI 80,0 - 1600 DN150/PN4		QA1000/ZI 80,0 - 1600 DN150/PN4																																																
	Input/Output		Conduit d'entrée/de sortie																																																
2.407	Double nipple , R1, Length 80 mm	2.407	Mamelon double , R1, longueur 80 mm																																																
2.408	Intermediate flange DN 50 Length 150 mm DN 80 Length 240 mm DN 100 Length 300 mm DN 150 Length 450 mm Relay and frequency converter see pos. 1.514 and 1.515	2.408	Bride intermédiaire DN 50 Longueur 150 mm DN 80 Longueur 240 mm DN 100 Longueur 300 mm DN 150 Longueur 450 mm Relais et convertisseur de fréquence voir pos. 1.514 et 1.515																																																

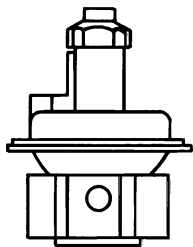

2.500
2.501

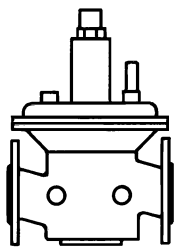

2.502

Nr.	Bezeichnung	Bestell-Nr. Order No. N° de commande	Preis EUR (o. MwSt.)
2.5 Druckregelgeräte			
Druckregelgeräte für Niederdruck max. Betriebsdruck 0,5 bar. Druckregelgerät auswählen bis zu einem Eingangsdruck von ca. 300 mbar. Preise einschl. oranger Feder (Regeldruck 5 - 20 mbar).			
2.500	Druckregelgerät DN FRS 503 RP 3/8 FRS 505 RP 1/2 FRS 507 RP 3/4 FRS 510 RP 1 FRS 515 RP 1 1/2 FRS 520 RP 2 * mit serienmäßiger Feder orange	640 681* 640 675* 640 676* 640 677* 640 678* 640 679*	
2.501	FRS 503 RP 3/8 FRS 505 RP 1/2 FRS 507 RP 3/4 FRS 510 RP 1 FRS 515 RP 1 1/2 FRS 520 RP 2 ¹⁾ Bei Druckregelgeräten mit anderen Ausgangsdrücken diese Bestellnummer verwenden und Feder von folgender Seite auswählen. Bestellnummer und Farbe der Feder angeben.	151 330 2698 ² ¹⁾ 151 330 2685 ² ¹⁾ 151 330 2686 ² ¹⁾ 151 330 2687 ² ¹⁾ 151 330 2688 ² ¹⁾ 151 330 2689 ² ¹⁾	
2.502	FRS 5040 40 FRS 5050 50 FRS 5065 65 FRS 5080 80 FRS 5100 100 FRS 5125 125 FRS 5150 150 ²⁾ mit Verbindungsteilen und Feder orange. Bei anderen Federn Bestellnummer der Feder und Farbe zusätzlich angeben.	151 329 2670 ² ²⁾ 151 329 2671 ² ²⁾ 151 329 2672 ² ²⁾ 151 329 2673 ² ²⁾ 151 329 2674 ² ²⁾ 151 331 2626 ² ²⁾ 151 331 2627 ² ²⁾	
2.503	Druckregelgeräte für Einsatz bei Brennern G1 - G7 Ausf. ZMA (auch bei Ausführung Simultan) FRS 507-2S FRS 510-2S FRS 515-2S FRS 520-2S FRS 5040-2S FRS 5050-2S FRS 5065-2S FRS 5080-2S FRS 5100-2S FRS 5125-2S	640 550 640 551 640 552 640 553 640 554 640 555 640 556 640 557 640 558 640 559	

No.	Description																
2.5	Gas governors																
	Low pressure governor Max. supply pressure 0.5 bar. Use device till max. 300 mbar. The prices are inclusive of orange spring (regulating pressure 5 - 20 mbar).																
2.500	<table border="0"> <tr> <td>Pressure regulator</td> <td>DN</td> </tr> <tr> <td>FRS 503</td> <td>RP 3/8</td> </tr> <tr> <td>FRS 505</td> <td>RP 1/2</td> </tr> <tr> <td>FRS 507</td> <td>RP 3/4</td> </tr> <tr> <td> </td> <td></td> </tr> <tr> <td>FRS 510</td> <td>RP 1</td> </tr> <tr> <td>FRS 515</td> <td>RP 1 1/2</td> </tr> <tr> <td>FRS 520</td> <td>RP 2</td> </tr> </table> <p>* with orange coloured spring</p>	Pressure regulator	DN	FRS 503	RP 3/8	FRS 505	RP 1/2	FRS 507	RP 3/4	 		FRS 510	RP 1	FRS 515	RP 1 1/2	FRS 520	RP 2
Pressure regulator	DN																
FRS 503	RP 3/8																
FRS 505	RP 1/2																
FRS 507	RP 3/4																
FRS 510	RP 1																
FRS 515	RP 1 1/2																
FRS 520	RP 2																
2.501	<table border="0"> <tr> <td>FRS 503</td> <td>RP 3/8</td> </tr> <tr> <td>FRS 505</td> <td>RP 1/2</td> </tr> <tr> <td>FRS 507</td> <td>RP 3/4</td> </tr> <tr> <td> </td> <td></td> </tr> <tr> <td>FRS 510</td> <td>RP 1</td> </tr> <tr> <td>FRS 515</td> <td>RP 1 1/2</td> </tr> <tr> <td>FRS 520</td> <td>RP 2</td> </tr> </table> <p>¹⁾ Use this order number for pressure regulators with other output pressures and select springs from the following page. Stipulate order number and colour of spring.</p>	FRS 503	RP 3/8	FRS 505	RP 1/2	FRS 507	RP 3/4	 		FRS 510	RP 1	FRS 515	RP 1 1/2	FRS 520	RP 2		
FRS 503	RP 3/8																
FRS 505	RP 1/2																
FRS 507	RP 3/4																
FRS 510	RP 1																
FRS 515	RP 1 1/2																
FRS 520	RP 2																
2.502	<table border="0"> <tr> <td>FRS 5040</td> <td>40</td> </tr> <tr> <td>FRS 5050</td> <td>50</td> </tr> <tr> <td>FRS 5065</td> <td>65</td> </tr> <tr> <td> </td> <td></td> </tr> <tr> <td>FRS 5080</td> <td>80</td> </tr> <tr> <td>FRS 5100</td> <td>100</td> </tr> <tr> <td>FRS 5125</td> <td>125</td> </tr> <tr> <td>FRS 5150</td> <td>150</td> </tr> </table> <p>²⁾ with connection parts and orange spring. For other springs stipulate order number and colour.</p>	FRS 5040	40	FRS 5050	50	FRS 5065	65	 		FRS 5080	80	FRS 5100	100	FRS 5125	125	FRS 5150	150
FRS 5040	40																
FRS 5050	50																
FRS 5065	65																
FRS 5080	80																
FRS 5100	100																
FRS 5125	125																
FRS 5150	150																
2.503	<p>Pressure regulators for use with burners G1 - G7 vers. ZMA (and with version Simultaneous)</p> <p>FRS 507-2S FRS 510-2S FRS 515-2S FRS 520-2S FRS 5040-2S FRS 5050-2S FRS 5065-2S FRS 5080-2S FRS 5100-2S FRS 5125-2S</p>																

No.	Dénomination																
2.5	Régulateurs de pression																
	Régulateurs de pression - basse pression Pression de service max. 0,5 bar. Régulateur à déterminer pour une pression d'entrée d'env. 300 mbar. Prix y compris ressort orange (pression de réglage 5 - 20 mbar).																
2.500	<table border="0"> <tr> <td>Régulateur</td> <td>DN</td> </tr> <tr> <td>FRS 503</td> <td>RP 3/8</td> </tr> <tr> <td>FRS 505</td> <td>RP 1/2</td> </tr> <tr> <td>FRS 507</td> <td>RP 3/4</td> </tr> <tr> <td> </td> <td></td> </tr> <tr> <td>FRS 510</td> <td>RP 1</td> </tr> <tr> <td>FRS 515</td> <td>RP 1 1/2</td> </tr> <tr> <td>FRS 520</td> <td>RP 2</td> </tr> </table> <p>* avec ressort orange</p>	Régulateur	DN	FRS 503	RP 3/8	FRS 505	RP 1/2	FRS 507	RP 3/4	 		FRS 510	RP 1	FRS 515	RP 1 1/2	FRS 520	RP 2
Régulateur	DN																
FRS 503	RP 3/8																
FRS 505	RP 1/2																
FRS 507	RP 3/4																
FRS 510	RP 1																
FRS 515	RP 1 1/2																
FRS 520	RP 2																
2.501	<table border="0"> <tr> <td>FRS 503</td> <td>RP 3/8</td> </tr> <tr> <td>FRS 505</td> <td>RP 1/2</td> </tr> <tr> <td>FRS 507</td> <td>RP 3/4</td> </tr> <tr> <td> </td> <td></td> </tr> <tr> <td>FRS 510</td> <td>RP 1</td> </tr> <tr> <td>FRS 515</td> <td>RP 1 1/2</td> </tr> <tr> <td>FRS 520</td> <td>RP 2</td> </tr> </table> <p>¹⁾ Utiliser cette référence pour des régulateurs avec des pressions de sortie différentes et déterminer les ressorts sur la page suivante. Référence et couleur des ressorts donnés.</p>	FRS 503	RP 3/8	FRS 505	RP 1/2	FRS 507	RP 3/4	 		FRS 510	RP 1	FRS 515	RP 1 1/2	FRS 520	RP 2		
FRS 503	RP 3/8																
FRS 505	RP 1/2																
FRS 507	RP 3/4																
FRS 510	RP 1																
FRS 515	RP 1 1/2																
FRS 520	RP 2																
2.502	<table border="0"> <tr> <td>FRS 5040</td> <td>40</td> </tr> <tr> <td>FRS 5050</td> <td>50</td> </tr> <tr> <td>FRS 5065</td> <td>65</td> </tr> <tr> <td> </td> <td></td> </tr> <tr> <td>FRS 5080</td> <td>80</td> </tr> <tr> <td>FRS 5100</td> <td>100</td> </tr> <tr> <td>FRS 5125</td> <td>125</td> </tr> <tr> <td>FRS 5150</td> <td>150</td> </tr> </table> <p>²⁾ avec éléments de liaison et ressort orange. Pour les autres ressorts, indiquer en plus la référence et la couleur du ressort.</p>	FRS 5040	40	FRS 5050	50	FRS 5065	65	 		FRS 5080	80	FRS 5100	100	FRS 5125	125	FRS 5150	150
FRS 5040	40																
FRS 5050	50																
FRS 5065	65																
FRS 5080	80																
FRS 5100	100																
FRS 5125	125																
FRS 5150	150																
2.503	<p>Régulateurs pour utilisation sur brûleurs G1 - G7 exéc. ZMA (également en exécution simultanée)</p> <p>FRS 507-2S FRS 510-2S FRS 515-2S FRS 520-2S FRS 5040-2S FRS 5050-2S FRS 5065-2S FRS 5080-2S FRS 5100-2S FRS 5125-2S</p>																



2.504

Nr.	Bezeichnung		Bestell-Nr. Order-No. N° de commande	Preis EUR (o.MWSt.)
2.504	Belastungsfedern für Niederdruck-Gasdruckregler, als Ersatzteile			
	Druckregelgerät - Typ	Kennfarbe	Ausgangsdruckbereich mbar	
	FRS 503	orange*	5 - 20	490 180
	FRS 505	blau	10 - 30	490 134
		rot	25 - 55	490 135
		gelb	30 - 70	490 136
		schwarz	60 - 110	490 137
		rosa	100 - 150	490 040
	FRS 507	orange*	5 - 20	490 181
		blau	10 - 30	490 139
		rot	25 - 55	490 140
		gelb	30 - 70	490 141
		schwarz	60 - 110	490 142
		rosa	100 - 150	490 041
	FRS 510	orange*	5 - 20	490 182
		blau	10 - 30	490 144
		rot	25 - 55	490 145
		gelb	30 - 70	490 146
		schwarz	60 - 110	490 147
		rosa	100 - 150	490 042
	FRS 5040	orange*	5 - 20	490 183
	FRS 515	blau	10 - 30	490 124
		rot	25 - 55	490 125
		gelb	30 - 70	490 126
		schwarz	60 - 110	490 127
		rosa	100 - 150	490 043
		grau	140 - 200	490 196
	FRS 5050/1	orange*	5 - 20	490 184
	FRS 520/1	blau	10 - 30	490 129
		rot	25 - 55	490 130
		gelb	30 - 70	490 131
		schwarz	60 - 110	490 132
		rosa	100 - 150	490 044
		grau	140 - 200	490 197
	FRS 5065	orange*	5 - 20	490 185
	FRS 5080	blau	10 - 30	490 119
		rot	25 - 55	490 120
		gelb	30 - 70	490 121
		schwarz	60 - 110	490 122
		rosa	100 - 150	490 045
		grau	140 - 200	490 198
	FRS 5100	orange*	5 - 20	490 187
		blau	10 - 30	490 035
		rot	25 - 55	490 036
		gelb	30 - 70	490 037
		schwarz	60 - 110	490 038
		rosa	100 - 150	490 039
		grau	140 - 200	490 199
	FRS 5125	orange*	5 - 20	490 188
		blau	10 - 30	490 093
		rot	25 - 55	490 096
		gelb	30 - 70	490 099
		schwarz	60 - 110	490 102
		rosa	100 - 150	490 048
		grau	140 - 200	490 229
	FRS 5150	orange*	5 - 20	490 189
		blau	10 - 30	490 094
		rot	25 - 55	490 097
		gelb	30 - 70	490 100
		schwarz	60 - 110	490 103
		rosa	100 - 150	490 049
		grau	140 - 200	490 230

* Serienmäßige Bestückung des Reglers

No.	Designation		
2.504	Springs for low pressure regulators, spare part		
	Pressure regulator	Spring type	Outlet pressure range mbar
	Type		
	FRS 503	orange*	5 - 20
	FRS 505	blue	10 - 30
		red	25 - 55
		yellow	30 - 70
		black	60 - 110
		pink	100 - 150
	FRS 507	orange*	5 - 20
		blue	10 - 30
		red	25 - 55
		yellow	30 - 70
		black	60 - 110
		pink	100 - 150
	FRS 510	orange*	5 - 20
		blue	10 - 30
		red	25 - 55
		yellow	30 - 70
		black	60 - 110
		pink	100 - 150
	FRS 5040	orange*	5 - 20
	FRS 515	blue	10 - 30
		red	25 - 55
		yellow	30 - 70
		black	60 - 110
		pink	100 - 150
		grey	140 - 200
	FRS 5050/1	orange*	5 - 20
	FRS 520/1	blue	10 - 30
		red	25 - 55
		yellow	30 - 70
		black	60 - 110
		pink	100 - 150
		grey	140 - 200
	FRS 5065	orange*	5 - 20
	FRS 5080	blue	10 - 30
		red	25 - 55
		yellow	30 - 70
		black	60 - 110
		pink	100 - 150
		grey	140 - 200
	FRS 5100	orange*	5 - 20
		blue	10 - 30
		red	25 - 55
		yellow	30 - 70
		black	60 - 110
		pink	100 - 150
		grey	140 - 200
	FRS 5125	orange*	5 - 20
		blue	10 - 30
		red	25 - 55
		yellow	30 - 70
		black	60 - 110
		pink	100 - 150
		grey	140 - 200
	FRS 5150	orange*	5 - 20
		blue	10 - 30
		red	25 - 55
		yellow	30 - 70
		black	60 - 110
		pink	100 - 150
		grey	140 - 200

*Factory selection

No.	Dénomination		
2.504	Ressorts pour régulateur basse pression, en pièces détachées		
	Régulateur - Type	Couleur	Pression de sortie mbar
	FRS 503	orange*	5 - 20
	FRS 505	bleu	10 - 30
		rouge	25 - 55
		jaune	30 - 70
		noir	60 - 110
		rose	100 - 150
	FRS 507	orange*	5 - 20
		bleu	10 - 30
		rouge	25 - 55
		jaune	30 - 70
		noir	60 - 110
		rose	100 - 150
	FRS 510	orange*	5 - 20
		bleu	10 - 30
		rouge	25 - 55
		jaune	30 - 70
		noir	60 - 110
		rose	100 - 150
	FRS 5040	orange*	5 - 20
	FRS 515	bleu	10 - 30
		rouge	25 - 55
		jaune	30 - 70
		noir	60 - 110
		rose	100 - 150
		gris	140 - 200
	FRS 5050/1	orange*	5 - 20
	FRS 520/1	bleu	10 - 30
		rouge	25 - 55
		jaune	30 - 70
		noir	60 - 110
		rose	100 - 150
		gris	140 - 200
	FRS 5065	orange*	5 - 20
	FRS 5080	bleu	10 - 30
		rouge	25 - 55
		jaune	30 - 70
		noir	60 - 110
		rose	100 - 150
		gris	140 - 200
	FRS 5100	orange*	5 - 20
		bleu	10 - 30
		rouge	25 - 55
		jaune	30 - 70
		noir	60 - 110
		rose	100 - 150
		gris	140 - 200
	FRS 5125	orange*	5 - 20
		bleu	10 - 30
		rouge	25 - 55
		jaune	30 - 70
		noir	60 - 110
		rose	100 - 150
		gris	140 - 200
	FRS 5150	orange*	5 - 20
		bleu	10 - 30
		rouge	25 - 55
		jaune	30 - 70
		noir	60 - 110
		rose	100 - 150
		gris	140 - 200

* Equipement de série du régulateur

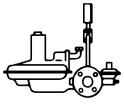

2.505

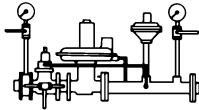

2.506

Nr.	Bezeichnung	Bestell-Nr. Order No. N° de commande	Preis EUR (o. MwSt.)
Druckregelgeräte für Hochdruck mit Sicherheitseinrichtungen Technische Erläuterung siehe Broschüren Druck Nr. 83001201 und 83197901			
2.505	Kompaktgerät		
	Typ Regler-Typ DN Vordruck max. bar		
	06/1 133 - 5 - 72 25 5,0	151 336 2666 0	
	07/1 133 - 5 - 72 25 5,0	151 336 2667 0	
	08/1 133 - 5 - 72 25 3,0	151 336 2646 0	
	09/1 133 - 5 - 72 25 1,5	151 336 2647 0	
	Kompaktgerät mit Sicherheitsmembrane *		
	06/1S 133 - 730 25 1,0	151 336 2668 0	
	07/1S 133 - 730 25 1,0	151 336 2669 0	
	08/1S 133 - 730 25 1,0	151 336 2670 0	
	09/1S 133 - 730 25 1,0	151 336 2671 0	
	Kompaktgerät		
	1/1 233 - 12 - 5 - 72 50 5,0	151 336 2648 0	
	2/1 233 - 12 - 5 - 72 50 5,0	151 336 2649 0	
	3/1 233 - 12 - 5 - 72 50 2,5	151 336 2650 0	
	4/1 233 - 12 - 5 - 72 50 1,0	151 336 2651 0	
	5/1 244 - 12 - 5 - 72 50 4,0	151 336 2652 0	
	Kompaktgerät mit Sicherheitsmembrane *		
	1/1S 233 - 12 - 730 50 1,0	151 336 2672 0	
	2/1S 233 - 12 - 730 50 1,0	151 336 2673 0	
	3/1S 233 - 12 - 730 50 1,0	151 336 2674 0	
	4/1S 233 - 12 - 730 50 1,0	151 336 2675 0	
2.506	Reglergruppen Baugröße 5 - 9		
	Typ Regler-Typ DN Vordruck max. bar		
	5/1-25-50 RR 16-25-31-8N-033 25 5	151 336 2637 0	
	5/1-25-80 RR 16-25-31-8N-033 25 5	151 336 2653 0	
	6/1-50-50 RR 16-50-31-8N-033 50 5	151 336 2638 0	
	6/1-50-80 RR 16-50-31-8N-033 50 5	151 336 2639 0	
	6/1A-50-50 RR 16-50-42-8N-033 50 5	151 336 2663 0	
	6/1A-50-80 RR 16-50-42-8N-033 50 5	151 336 2664 0	
	6/1A-50-100 RR 16-50-42-8N-033 50 5	151 336 2665 0	
	7/1-50-50 RR 16-50-54-12N-033 50 5	151 336 2640 0	
	7/1-50-80 RR 16-50-54-12N-033 50 5	151 336 2641 0	
	7/1-50-100 RR 16-50-54-12N-033 50 5	151 336 2642 0	
	8/1-80-80 RR 16-80-82-12N-033 80 4	151 336 2643 0	
	8/1-80-100 RR 16-80-82-12N-033 80 4	151 336 2644 0	
	8/1-80-150 RR 16-80-82-12N-033 80 4	151 336 2645 0	
	9/1-100-100 RBE 4020 100 5	151 336 2676 0	
	9/1-100-150 RBE 4020 100 5	151 336 2677 0	
	Mehrpreis für Ausführung Klärgas auf Anfrage		
2.507	Druckregelgeräte für Hochdruck mit Sicherheitseinrichtungen für Ausgangsdrücke 180 - 350 mbar		
	Typ Regler-Typ DN Vordruck max. bar		
	5/2a-So-25/80 RR 16-25-31-8N-SL-IZN.1 25 10	151 336 2678 0	
	6/2-So-50/100 RR 16-50-31-8N-SL-IZN.1 50 10	151 336 2679 0	
	6/2a-So-50/100 RR 16-50-42-8N-SL-IZN.1 50 10	151 336 2680 0	
	7/1-So-50/100 RR 16-50-54-8N-SL-IZN.1 50 5	151 336 2681 0	
	8/1-So-80/150 RR16-80-82-8N-SL-IZN.1 80 4	151 336 2682 0	
	9/1-So-100/150 RBE 4020 100 5	151 336 2683 0	
	Federn für Ausgangsdruck >200 mbar		
	Reglertyp Ausgangsdruck mbar Farbe		
	RR 16 200 - 330 orange	490 179	
	RR 16 300 - 450 schwarz	490 195	
	RBE 4020 180 - 290 silber	490 237	
	RBE 4020 240 - 370 violett	490 234	
	(* Achtung: Lieferzeit ca. 6 Wochen)		

No.	Description
	Pressure regulators for high pressure with safety device Technical explanation, see brochure print No. 83001202 and 1979

2.505 Compact unit					
Type	Regulator type	DN	Nozzle mm	Nozzle inch	Supply press. max. bar
06/1	133 - 5 - 72	25	3,0	1/8"	5,0
07/1	133 - 5 - 72	25	4,7	3/16"	5,0
08/1	133 - 5 - 72	25	6,3	1/4"	3,0
09/1	133 - 5 - 72	25	12,5	1/2"	1,5

Compact unit with safety diaphragm (Attention: Delivery time approx. 6 weeks)					
06/1S	133 - 730	25	3,0	1/8"	1,0
07/1S	133 - 730	25	4,7	3/16"	1,0
08/1S	133 - 730	25	6,3	1/4"	1,0
09/1S	133 - 730	25	12,5	1/2"	1,0

Compact unit					
1/1	233 - 12 - 5 - 72	50	10	3/8"	5,0
2/1	233 - 12 - 5 - 72	50	12,5	1/2"	5,0
3/1	233 - 12 - 5 - 72	50	20	3/4"	2,5
4/1	233 - 12 - 5 - 72	50	25	1"	1,0
5/1	244 - 12 - 5 - 72	50	27,5	-	4,0

Compact unit with safety diaphragm (Attention: Delivery time approx. 6 weeks)					
1/1S	233 - 12 - 730	50	10	3/8"	1,0
2/1S	233 - 12 - 730	50	12,5	1/2"	1,0
3/1S	233 - 12 - 730	50	20	3/4"	1,0
4/1S	233 - 12 - 730	50	25	1"	1,0

2.506 Regulator groups sizes 5 - 9				
Type	Regulator type	DN	Supply press. max. bar	
5/1-25-50	RR 16-25-31-8N-033	25	5	
5/1-25-80	RR 16-25-31-8N-033	25	5	
6/1-50-50	RR 16-50-31-8N-033	50	5	
6/1-50-80	RR 16-50-31-8N-033	50	5	
6/1A-50-50	RR 16-50-42-8N-033	50	5	
6/1A-50-80	RR 16-50-42-8N-033	50	5	
6/1A-50-100	RR 16-50-42-8N-033	50	5	
7/1-50-50	RR 16-50-54-12N-033	50	5	
7/1-50-80	RR 16-50-54-12N-033	50	5	
7/1-50-100	RR 16-50-54-12N-033	50	5	
8/1-80-80	RR 16-80-82-12N-033	80	4	
8/1-80-100	RR 16-80-82-12N-033	80	4	
8/1-80-150	RR 16-80-82-12N-033	80	4	
9/1-100-100	RBE 4020	100	5	
9/1-100-150	RBE 4020	100	5	

Additional price for version sewage gas on request

2.507 Pressure regulators for high pressure with safety assemblies for outlet pressures 180 - 350 mbar				
Type	Regulator type	DN	Nozzle mm	
5/2a-So-25/80	RR 16-25-31-8N-SL-IZN.1	25	31	
6/2-So-50/100	RR 16-50-31-8N-SL-IZN.1	50	31	
6/2a-So-50/100	RR 16-50-42-8N-SL-IZN.1	50	42	
7/1-So-50/100	RR 16-50-54-8N-SL-IZN.1	50	54	
8/1-So-80/150	RR16-80-82-8N-SL-IZN.1	80	82	
9/1-So-100/150	RBE 4020	100	100	

Springs for outlet pressure >200 mbar			
Regulator type	Outlet pressure mbar	Colour	
RR 16	200 - 330	orange	
RR 16	300 - 450	black	
RBE 4020	180 - 290	silver	
RBE 4020	240 - 370	violet	

(* Note: Delivery time approximately 6 weeks)

No.	Dénomination
	Régulateurs haute pression avec dispositif de sécurité Explications techniques voir brochure n° d'impr. 12 et 1979

2.505 Appareil compact						
Type	Régulateur type	DN	Gicleur mm	Gicleur pouce	Pression amont max. bar	
06/1	133 - 5 - 72	25	3,0	1/8"	5,0	
07/1	133 - 5 - 72	25	4,7	3/16"	5,0	
08/1	133 - 5 - 72	25	6,3	1/4"	3,0	
09/1	133 - 5 - 72	25	12,5	1/2"	1,5	

Appareil compact avec membrane de sécurité (attention : délai de livraison 6 semaines)						
06/1S	133 - 730	25	3,0	1/8"	1,0	
07/1S	133 - 730	25	4,7	3/16"	1,0	
08/1S	133 - 730	25	6,3	1/4"	1,0	
09/1S	133 - 730	25	12,5	1/2"	1,0	

Appareil compact						
1/1	233 - 12 - 5 - 72	50	10	3/8"	5,0	
2/1	233 - 12 - 5 - 72	50	12,5	1/2"	5,0	
3/1	233 - 12 - 5 - 72	50	20	3/4"	2,5	
4/1	233 - 12 - 5 - 72	50	25	1"	1,0	
5/1	244 - 12 - 5 - 72	50	27,5	-	4,0	

Appareil compact avec membrane de sécurité (attention : délai de livraison 6 semaines)						
1/1S	233 - 12 - 730	50	10	3/8"	1,0	
2/1S	233 - 12 - 730	50	12,5	1/2"	1,0	
3/1S	233 - 12 - 730	50	20	3/4"	1,0	
4/1S	233 - 12 - 730	50	25	1"	1,0	

2.506 Groupes de régulation grandeur 5 - 9				
Type	Régulateur type	DN	Pression amont max. bar	
5/1-25-50	RR 16-25-31-8N-033	25	5	
5/1-25-80	RR 16-25-31-8N-033	25	5	
6/1-50-50	RR 16-50-31-8N-033	50	5	
6/1-50-80	RR 16-50-31-8N-033	50	5	
6/1A-50-50	RR 16-50-42-8N-033	50	5	
6/1A-50-80	RR 16-50-42-8N-033	50	5	
6/1A-50-100	RR 16-50-42-8N-033	50	5	
7/1-50-50	RR 16-50-54-12N-033	50	5	
7/1-50-80	RR 16-50-54-12N-033	50	5	
7/1-50-100	RR 16-50-54-12N-033	50	5	
8/1-80-80	RR 16-80-82-12N-033	80	4	
8/1-80-100	RR 16-80-82-12N-033	80	4	
8/1-80-150	RR 16-80-82-12N-033	80	4	
9/1-100-100	RBE 4020	100	5	
9/1-100-150	RBE 4020	100	5	

Plus-value pour exécution biogaz

2.507 Régulateurs haute pression avec dispositif de sécurité pour pressions de sortie 180 - 350 mbar				
Type	Régulateur type	DN	Gicleur mm	
5/2a-So-25/80	RR 16-25-31-8N-SL-IZN.1	25	31	
6/2-So-50/100	RR 16-50-31-8N-SL-IZN.1	50	31	
6/2a-So-50/100	RR 16-50-42-8N-SL-IZN.1	50	42	
7/1-So-50/100	RR 16-50-54-8N-SL-IZN.1	50	54	
8/1-So-80/150	RR16-80-82-8N-SL-IZN.1	80	82	
9/1-So-100/150	RBE 4020	100	100	

Ressorts pour pression de sortie >200 mbar			
Type régulateur	Pression de sortie mbar	Couleur	
RR 16	200 - 330	orange	
RR 16	300 - 450	noir	
RBE 4020	180 - 290	argent	
RBE 4020	240 - 370	violet	

(* Attention : délai de livraison env. 6 semaines)

Nr.	Bezeichnung				Bestell-Nr. Order No. N° de commande	Preis EUR (o. MwSt.)	
2.508	Federn für Ausgangsdruck						
	Reglertyp	Einstellbereich mbar	Farbe				
	06/1 bis 09/1	12 - 20	blau		490 031		
	06/1 bis 09/1	15 - 35	grün		490 032		
	06/1 bis 09/1	30 - 70	orange		490 033		
	06/1 bis 09/1	50 - 140	schwarz/weiß		490 030		
	06/1 bis 09/1	100 - 210	silber (blank)		490 029		
	1/1 - 5/1	15 - 35	grün		490 085		
	1/1 - 5/1	30 - 70	orange		490 086		
	1/1 - 5/1	70 - 140	schwarz		490 087		
	1/1 - 5/1	100 - 210	silber (blank)		490 088		
	5/1 - 6/1	15 - 35	orange/grau		490 190		
	5/1 - 6/1	30 - 70	gelb/schwarz		490 191		
	5/1 - 6/1	70 - 140	rot/blau		490 192		
	5/1 - 6/1	100 - 210	grün/weiß		490 194		
	7/1 - 8/1	15 - 35	gelb/schwarz		490 191		
	7/1 - 8/1	30 - 70	rot/blau		490 192		
	7/1 - 8/1	70 - 140	blau/grün		490 193		
	7/1 - 8/1	100 - 210	schwarz		490 195		
	9/1	120 - 240	blau		490 238		
2.509	Kompaktgerät für Drücke größer 4 bar						
	Typ	Regler-Typ	DN	Düse	Vordruck max. bar		
	07/2-25/50	133-6-66	25/50	3	6	151 336 2659 0	
	08/2-25/50	133-6-66	25/50	4,7	6	151 336 2660 0	
	1/2-50/50	233-12-6-66	50	10	6	151 336 2661 0	
	2/2-50/50	233-12-6-66	50	12,5	6	151 336 2662 0	
2.510	Federn für Ausgangsdruck						
	Reglertyp	Einstellbereich mbar	Farbe				
	07/2 und 08/2	12 - 20	blau		490 031		
	07/2 und 08/2	15 - 35	grün		490 032		
	07/2 und 08/2	30 - 70	orange		490 033		
	07/2 und 08/2	50 - 140	schwarz/weiß		490 030		
	07/2 und 08/2	100 - 210	silber		490 029		
	1/2 und 2/2	15 - 35	grün		490 085		
	1/2 und 2/2	30 - 70	orange		490 086		
	1/2 und 2/2	70 - 140	schwarz		490 087		
	1/2 und 2/2	100 - 210	silber		490 088		
2.511	Reglergruppen Baugröße 5 und 6 für Drücke größer 4 bar						
	Typ	Regler-Typ	DN	Düse	Vordruck max. bar		
	5/2-25/80	RR16-25-24-8N-SL-IZN.1	25	24	10	151 336 2654 0	
	5/2a-25/80	RR16-25-31-8N-SL-IZN.1	25	31	10	151 336 2655 0	
	6/2-50/100	RR16-50-31-8N-SL-IZN.1	50	31	10	151 336 2657 0	
	6/2a-50/100	RR16-50-42-8N-SL-IZN.1	50	42	10	151 336 2658 0	

No.	Description																																																									
2.508	<p>Springs for outlet pressure</p> <table border="1"> <thead> <tr> <th>Regulator type</th> <th>Setting range mbar</th> <th>Colour</th> </tr> </thead> <tbody> <tr> <td>06/1 bis 09/1</td> <td>12 - 20</td> <td>blue</td> </tr> <tr> <td>06/1 bis 09/1</td> <td>15 - 35</td> <td>green</td> </tr> <tr> <td>06/1 bis 09/1</td> <td>30 - 70</td> <td>orange</td> </tr> <tr> <td>06/1 bis 09/1</td> <td>50 - 140</td> <td>black/white</td> </tr> <tr> <td>06/1 bis 09/1</td> <td>100 - 210</td> <td>silver</td> </tr> <tr> <td>1/1 - 5/1</td> <td>15 - 35</td> <td>green</td> </tr> <tr> <td>1/1 - 5/1</td> <td>30 - 70</td> <td>orange</td> </tr> <tr> <td>1/1 - 5/1</td> <td>70 - 140</td> <td>black</td> </tr> <tr> <td>1/1 - 5/1</td> <td>100 - 210</td> <td>silver</td> </tr> <tr> <td>5/1 - 6/1</td> <td>15 - 35</td> <td>orange/grey</td> </tr> <tr> <td>5/1 - 6/1</td> <td>30 - 70</td> <td>yellow/black</td> </tr> <tr> <td>5/1 - 6/1</td> <td>70 - 140</td> <td>red/blue</td> </tr> <tr> <td>5/1 - 6/1</td> <td>100 - 210</td> <td>green/white</td> </tr> <tr> <td>7/1 - 8/1</td> <td>15 - 35</td> <td>yellow/black</td> </tr> <tr> <td>7/1 - 8/1</td> <td>30 - 70</td> <td>red/blue</td> </tr> <tr> <td>7/1 - 8/1</td> <td>70 - 140</td> <td>blue/green</td> </tr> <tr> <td>7/1 - 8/1</td> <td>100 - 210</td> <td>black</td> </tr> <tr> <td>9/1</td> <td>120 - 240</td> <td>blue</td> </tr> </tbody> </table>	Regulator type	Setting range mbar	Colour	06/1 bis 09/1	12 - 20	blue	06/1 bis 09/1	15 - 35	green	06/1 bis 09/1	30 - 70	orange	06/1 bis 09/1	50 - 140	black/white	06/1 bis 09/1	100 - 210	silver	1/1 - 5/1	15 - 35	green	1/1 - 5/1	30 - 70	orange	1/1 - 5/1	70 - 140	black	1/1 - 5/1	100 - 210	silver	5/1 - 6/1	15 - 35	orange/grey	5/1 - 6/1	30 - 70	yellow/black	5/1 - 6/1	70 - 140	red/blue	5/1 - 6/1	100 - 210	green/white	7/1 - 8/1	15 - 35	yellow/black	7/1 - 8/1	30 - 70	red/blue	7/1 - 8/1	70 - 140	blue/green	7/1 - 8/1	100 - 210	black	9/1	120 - 240	blue
Regulator type	Setting range mbar	Colour																																																								
06/1 bis 09/1	12 - 20	blue																																																								
06/1 bis 09/1	15 - 35	green																																																								
06/1 bis 09/1	30 - 70	orange																																																								
06/1 bis 09/1	50 - 140	black/white																																																								
06/1 bis 09/1	100 - 210	silver																																																								
1/1 - 5/1	15 - 35	green																																																								
1/1 - 5/1	30 - 70	orange																																																								
1/1 - 5/1	70 - 140	black																																																								
1/1 - 5/1	100 - 210	silver																																																								
5/1 - 6/1	15 - 35	orange/grey																																																								
5/1 - 6/1	30 - 70	yellow/black																																																								
5/1 - 6/1	70 - 140	red/blue																																																								
5/1 - 6/1	100 - 210	green/white																																																								
7/1 - 8/1	15 - 35	yellow/black																																																								
7/1 - 8/1	30 - 70	red/blue																																																								
7/1 - 8/1	70 - 140	blue/green																																																								
7/1 - 8/1	100 - 210	black																																																								
9/1	120 - 240	blue																																																								
2.509	<p>Compact unit for pressures above 4 bar</p> <table border="1"> <thead> <tr> <th>Type</th> <th>Regulator type</th> <th>DN</th> <th>Nozzle</th> <th>Supply press. max. bar</th> </tr> </thead> <tbody> <tr> <td>07/2-25/50</td> <td>133-6-66</td> <td>25/50</td> <td>3</td> <td>6</td> </tr> <tr> <td>08/2-25/50</td> <td>133-6-66</td> <td>25/50</td> <td>4,7</td> <td>6</td> </tr> <tr> <td>1/2-50/50</td> <td>233-12-6-66</td> <td>50</td> <td>10</td> <td>6</td> </tr> <tr> <td>2/2-50/50</td> <td>233-12-6-66</td> <td>50</td> <td>12,5</td> <td>6</td> </tr> </tbody> </table>	Type	Regulator type	DN	Nozzle	Supply press. max. bar	07/2-25/50	133-6-66	25/50	3	6	08/2-25/50	133-6-66	25/50	4,7	6	1/2-50/50	233-12-6-66	50	10	6	2/2-50/50	233-12-6-66	50	12,5	6																																
Type	Regulator type	DN	Nozzle	Supply press. max. bar																																																						
07/2-25/50	133-6-66	25/50	3	6																																																						
08/2-25/50	133-6-66	25/50	4,7	6																																																						
1/2-50/50	233-12-6-66	50	10	6																																																						
2/2-50/50	233-12-6-66	50	12,5	6																																																						
2.510	<p>Springs for outlet pressure</p> <table border="1"> <thead> <tr> <th>Regulator type</th> <th>Setting range mbar</th> <th>Colour</th> </tr> </thead> <tbody> <tr> <td>07/2 and 08/2</td> <td>12 - 20</td> <td>blue</td> </tr> <tr> <td>07/2 and 08/2</td> <td>15 - 35</td> <td>green</td> </tr> <tr> <td>07/2 and 08/2</td> <td>30 - 70</td> <td>orange</td> </tr> <tr> <td>07/2 and 08/2</td> <td>50 - 140</td> <td>black/white</td> </tr> <tr> <td>07/2 and 08/2</td> <td>100 - 210</td> <td>silver</td> </tr> <tr> <td>1/2 and 2/2</td> <td>15 - 35</td> <td>green</td> </tr> <tr> <td>1/2 and 2/2</td> <td>30 - 70</td> <td>orange</td> </tr> <tr> <td>1/2 and 2/2</td> <td>70 - 140</td> <td>black</td> </tr> <tr> <td>1/2 and 2/2</td> <td>100 - 210</td> <td>silver</td> </tr> </tbody> </table>	Regulator type	Setting range mbar	Colour	07/2 and 08/2	12 - 20	blue	07/2 and 08/2	15 - 35	green	07/2 and 08/2	30 - 70	orange	07/2 and 08/2	50 - 140	black/white	07/2 and 08/2	100 - 210	silver	1/2 and 2/2	15 - 35	green	1/2 and 2/2	30 - 70	orange	1/2 and 2/2	70 - 140	black	1/2 and 2/2	100 - 210	silver																											
Regulator type	Setting range mbar	Colour																																																								
07/2 and 08/2	12 - 20	blue																																																								
07/2 and 08/2	15 - 35	green																																																								
07/2 and 08/2	30 - 70	orange																																																								
07/2 and 08/2	50 - 140	black/white																																																								
07/2 and 08/2	100 - 210	silver																																																								
1/2 and 2/2	15 - 35	green																																																								
1/2 and 2/2	30 - 70	orange																																																								
1/2 and 2/2	70 - 140	black																																																								
1/2 and 2/2	100 - 210	silver																																																								
2.511	<p>Regulator groups size 5 and 6 for pressures above 4 bar</p> <table border="1"> <thead> <tr> <th>Type</th> <th>Regulator type</th> <th>DN</th> <th>Nozzle</th> <th>Supply press. max. bar</th> </tr> </thead> <tbody> <tr> <td>5/2-25/80</td> <td>RR16-25-24-8N-SL-IZN.1</td> <td>25</td> <td>24</td> <td>10</td> </tr> <tr> <td>5/2a-25/80</td> <td>RR16-25-31-8N-SL-IZN.1</td> <td>25</td> <td>31</td> <td>10</td> </tr> <tr> <td>6/2-50/100</td> <td>RR16-50-31-8N-SL-IZN.1</td> <td>50</td> <td>31</td> <td>10</td> </tr> <tr> <td>6/2a-50/100</td> <td>RR16-50-42-8N-SL-IZN.1</td> <td>50</td> <td>42</td> <td>10</td> </tr> </tbody> </table>	Type	Regulator type	DN	Nozzle	Supply press. max. bar	5/2-25/80	RR16-25-24-8N-SL-IZN.1	25	24	10	5/2a-25/80	RR16-25-31-8N-SL-IZN.1	25	31	10	6/2-50/100	RR16-50-31-8N-SL-IZN.1	50	31	10	6/2a-50/100	RR16-50-42-8N-SL-IZN.1	50	42	10																																
Type	Regulator type	DN	Nozzle	Supply press. max. bar																																																						
5/2-25/80	RR16-25-24-8N-SL-IZN.1	25	24	10																																																						
5/2a-25/80	RR16-25-31-8N-SL-IZN.1	25	31	10																																																						
6/2-50/100	RR16-50-31-8N-SL-IZN.1	50	31	10																																																						
6/2a-50/100	RR16-50-42-8N-SL-IZN.1	50	42	10																																																						

No.	Dénomination																																																									
2.508	<p>Ressorts pour pression de sortie</p> <table border="1"> <thead> <tr> <th>Régulateur type</th> <th>Plage de réglage mbar</th> <th>Couleur</th> </tr> </thead> <tbody> <tr> <td>06/1 jusqu'à 09/1</td> <td>12 - 20</td> <td>bleu</td> </tr> <tr> <td>06/1 jusqu'à 09/1</td> <td>15 - 35</td> <td>vert</td> </tr> <tr> <td>06/1 jusqu'à 09/1</td> <td>30 - 70</td> <td>orange</td> </tr> <tr> <td>06/1 jusqu'à 09/1</td> <td>50 - 140</td> <td>noir/blanc</td> </tr> <tr> <td>06/1 jusqu'à 09/1</td> <td>100 - 210</td> <td>argenté (brillant)</td> </tr> <tr> <td>1/1 - 5/1</td> <td>15 - 35</td> <td>vert</td> </tr> <tr> <td>1/1 - 5/1</td> <td>30 - 70</td> <td>orange</td> </tr> <tr> <td>1/1 - 5/1</td> <td>70 - 140</td> <td>noir</td> </tr> <tr> <td>1/1 - 5/1</td> <td>100 - 210</td> <td>argenté (brillant)</td> </tr> <tr> <td>5/1 - 6/1</td> <td>15 - 35</td> <td>orange/gris</td> </tr> <tr> <td>5/1 - 6/1</td> <td>30 - 70</td> <td>jaune/noir</td> </tr> <tr> <td>5/1 - 6/1</td> <td>70 - 140</td> <td>rouge/bleu</td> </tr> <tr> <td>5/1 - 6/1</td> <td>100 - 210</td> <td>vert/blanc</td> </tr> <tr> <td>7/1 - 8/1</td> <td>15 - 35</td> <td>jaune/noir</td> </tr> <tr> <td>7/1 - 8/1</td> <td>30 - 70</td> <td>rouge/bleu</td> </tr> <tr> <td>7/1 - 8/1</td> <td>70 - 140</td> <td>bleu/vert</td> </tr> <tr> <td>7/1 - 8/1</td> <td>100 - 210</td> <td>noir</td> </tr> <tr> <td>9/1</td> <td>120 - 240</td> <td>bleu</td> </tr> </tbody> </table>	Régulateur type	Plage de réglage mbar	Couleur	06/1 jusqu'à 09/1	12 - 20	bleu	06/1 jusqu'à 09/1	15 - 35	vert	06/1 jusqu'à 09/1	30 - 70	orange	06/1 jusqu'à 09/1	50 - 140	noir/blanc	06/1 jusqu'à 09/1	100 - 210	argenté (brillant)	1/1 - 5/1	15 - 35	vert	1/1 - 5/1	30 - 70	orange	1/1 - 5/1	70 - 140	noir	1/1 - 5/1	100 - 210	argenté (brillant)	5/1 - 6/1	15 - 35	orange/gris	5/1 - 6/1	30 - 70	jaune/noir	5/1 - 6/1	70 - 140	rouge/bleu	5/1 - 6/1	100 - 210	vert/blanc	7/1 - 8/1	15 - 35	jaune/noir	7/1 - 8/1	30 - 70	rouge/bleu	7/1 - 8/1	70 - 140	bleu/vert	7/1 - 8/1	100 - 210	noir	9/1	120 - 240	bleu
Régulateur type	Plage de réglage mbar	Couleur																																																								
06/1 jusqu'à 09/1	12 - 20	bleu																																																								
06/1 jusqu'à 09/1	15 - 35	vert																																																								
06/1 jusqu'à 09/1	30 - 70	orange																																																								
06/1 jusqu'à 09/1	50 - 140	noir/blanc																																																								
06/1 jusqu'à 09/1	100 - 210	argenté (brillant)																																																								
1/1 - 5/1	15 - 35	vert																																																								
1/1 - 5/1	30 - 70	orange																																																								
1/1 - 5/1	70 - 140	noir																																																								
1/1 - 5/1	100 - 210	argenté (brillant)																																																								
5/1 - 6/1	15 - 35	orange/gris																																																								
5/1 - 6/1	30 - 70	jaune/noir																																																								
5/1 - 6/1	70 - 140	rouge/bleu																																																								
5/1 - 6/1	100 - 210	vert/blanc																																																								
7/1 - 8/1	15 - 35	jaune/noir																																																								
7/1 - 8/1	30 - 70	rouge/bleu																																																								
7/1 - 8/1	70 - 140	bleu/vert																																																								
7/1 - 8/1	100 - 210	noir																																																								
9/1	120 - 240	bleu																																																								
2.509	<p>Appareil compact pour pressions supérieures à 4 bar</p> <table border="1"> <thead> <tr> <th>Type</th> <th>Régulateur type</th> <th>DN</th> <th>Gicleur</th> <th>Pression amont max. bar</th> </tr> </thead> <tbody> <tr> <td>07/2-25/50</td> <td>133-6-66</td> <td>25/50</td> <td>3</td> <td>6</td> </tr> <tr> <td>08/2-25/50</td> <td>133-6-66</td> <td>25/50</td> <td>4,7</td> <td>6</td> </tr> <tr> <td>1/2-50/50</td> <td>233-12-6-66</td> <td>50</td> <td>10</td> <td>6</td> </tr> <tr> <td>2/2-50/50</td> <td>233-12-6-66</td> <td>50</td> <td>12,5</td> <td>6</td> </tr> </tbody> </table>	Type	Régulateur type	DN	Gicleur	Pression amont max. bar	07/2-25/50	133-6-66	25/50	3	6	08/2-25/50	133-6-66	25/50	4,7	6	1/2-50/50	233-12-6-66	50	10	6	2/2-50/50	233-12-6-66	50	12,5	6																																
Type	Régulateur type	DN	Gicleur	Pression amont max. bar																																																						
07/2-25/50	133-6-66	25/50	3	6																																																						
08/2-25/50	133-6-66	25/50	4,7	6																																																						
1/2-50/50	233-12-6-66	50	10	6																																																						
2/2-50/50	233-12-6-66	50	12,5	6																																																						
2.510	<p>Ressorts pour pression de sortie</p> <table border="1"> <thead> <tr> <th>Régulateur type</th> <th>Plage de réglage mbar</th> <th>Couleur</th> </tr> </thead> <tbody> <tr> <td>07/2 et 08/2</td> <td>12 - 20</td> <td>bleu</td> </tr> <tr> <td>07/2 et 08/2</td> <td>15 - 35</td> <td>vert</td> </tr> <tr> <td>07/2 et 08/2</td> <td>30 - 70</td> <td>orange</td> </tr> <tr> <td>07/2 et 08/2</td> <td>50 - 140</td> <td>noir/blanc</td> </tr> <tr> <td>07/2 et 08/2</td> <td>100 - 210</td> <td>argenté</td> </tr> <tr> <td>1/2 et 2/2</td> <td>15 - 35</td> <td>vert</td> </tr> <tr> <td>1/2 et 2/2</td> <td>30 - 70</td> <td>orange</td> </tr> <tr> <td>1/2 et 2/2</td> <td>70 - 140</td> <td>noir</td> </tr> <tr> <td>1/2 et 2/2</td> <td>100 - 210</td> <td>argenté</td> </tr> </tbody> </table>	Régulateur type	Plage de réglage mbar	Couleur	07/2 et 08/2	12 - 20	bleu	07/2 et 08/2	15 - 35	vert	07/2 et 08/2	30 - 70	orange	07/2 et 08/2	50 - 140	noir/blanc	07/2 et 08/2	100 - 210	argenté	1/2 et 2/2	15 - 35	vert	1/2 et 2/2	30 - 70	orange	1/2 et 2/2	70 - 140	noir	1/2 et 2/2	100 - 210	argenté																											
Régulateur type	Plage de réglage mbar	Couleur																																																								
07/2 et 08/2	12 - 20	bleu																																																								
07/2 et 08/2	15 - 35	vert																																																								
07/2 et 08/2	30 - 70	orange																																																								
07/2 et 08/2	50 - 140	noir/blanc																																																								
07/2 et 08/2	100 - 210	argenté																																																								
1/2 et 2/2	15 - 35	vert																																																								
1/2 et 2/2	30 - 70	orange																																																								
1/2 et 2/2	70 - 140	noir																																																								
1/2 et 2/2	100 - 210	argenté																																																								
2.511	<p>Groupes de régulation tailles 5 et 6 pour pressions supérieures à 4 bar</p> <table border="1"> <thead> <tr> <th>Type</th> <th>Régulateur type</th> <th>DN</th> <th>Gicleur</th> <th>Pression amont max. bar</th> </tr> </thead> <tbody> <tr> <td>5/2-25/80</td> <td>RR16-25-24-8N-SL-IZN.1</td> <td>25</td> <td>24</td> <td>10</td> </tr> <tr> <td>5/2a-25/80</td> <td>RR16-25-31-8N-SL-IZN.1</td> <td>25</td> <td>31</td> <td>10</td> </tr> <tr> <td>6/2-50/100</td> <td>RR16-50-31-8N-SL-IZN.1</td> <td>50</td> <td>31</td> <td>10</td> </tr> <tr> <td>6/2a-50/100</td> <td>RR16-50-42-8N-SL-IZN.1</td> <td>50</td> <td>42</td> <td>10</td> </tr> </tbody> </table>	Type	Régulateur type	DN	Gicleur	Pression amont max. bar	5/2-25/80	RR16-25-24-8N-SL-IZN.1	25	24	10	5/2a-25/80	RR16-25-31-8N-SL-IZN.1	25	31	10	6/2-50/100	RR16-50-31-8N-SL-IZN.1	50	31	10	6/2a-50/100	RR16-50-42-8N-SL-IZN.1	50	42	10																																
Type	Régulateur type	DN	Gicleur	Pression amont max. bar																																																						
5/2-25/80	RR16-25-24-8N-SL-IZN.1	25	24	10																																																						
5/2a-25/80	RR16-25-31-8N-SL-IZN.1	25	31	10																																																						
6/2-50/100	RR16-50-31-8N-SL-IZN.1	50	31	10																																																						
6/2a-50/100	RR16-50-42-8N-SL-IZN.1	50	42	10																																																						

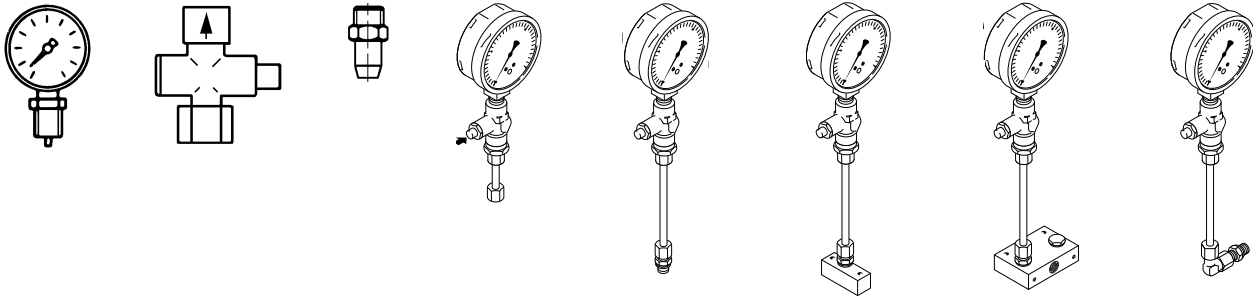

2.601 2.602 2.603 2.606 2.607 2.608 2.609 2.610

Nr.	Bezeichnung	Bestell-Nr. Order No. N° de commande	Preis EUR (o. MwSt.)
2.6 Manometer und Prüfbrenner			
2.601	Manometer Gehäuse ø 100 mm Anschluss R 1/2" unten		
	Einsatzbereich überdrucksicher		
	0 - 25 mbar 0 - 18 mbar 1,3 fach	641 143	
	0 - 60 mbar 0 - 45 mbar 10 fach	641 144	
	0 - 160 mbar 0 - 120 mbar 10 fach	641 145	
	0 - 400 mbar 0 - 300 mbar 10 fach	641 146	
	0 - 1,6 bar 0 - 1,2 bar 1,3 fach	641 148	
	0 - 2,5 bar 0 - 1,8 bar 1,3 fach	641 149	
	0 - 4,0 bar 0 - 3,0 bar 1,3 fach	641 150	
	0 - 6,0 bar 0 - 4,5 bar 1,3 fach	641 151	
	0 - 10,0 bar 0 - 7,5 bar 1,3 fach	641 152	
	0 - 16,0 bar 0 - 12 bar 10 fach	641 153	
2.602	Druckknopfahn , G 1/2, CE-0085 AQ 0985, max. Betriebsdruck 5 bar	454 099	
2.603	Druckmessnippel G 1/8	453 001	
	G 1/4	453 005	
2.604	Dichtung G 1/8	441 033	
	G 1/4	441 028	
2.605	Doppelnippel R 1/4 mit Dämpfungsdüse 0,3	151 223 2602 2	
	Manometer , komplett mit Druckknopfahn, Leitung und Verschraubung auch für Anlagen nach TRD 604 geeignet (Ausführung B, G 1/4 Anschluss an Gasfilter sowie DMV ohne GW)		
2.606	Manometer komplett (bei zusätzlichem GW...A6 oder Prüfbrenner)		
	Einsatzbereich		
	0 - 25 mbar 0 - 18 mbar	151 336 2694 2	
	0 - 60 mbar 0 - 45 mbar	151 336 2695 2	
	0 - 160 mbar 0 - 120 mbar	151 336 2696 2	
	0 - 400 mbar 0 - 300 mbar	151 336 2697 2	
2.607	Manometer komplett G1/4 für DMV geflanscht oder Anschluss am Gasfilter		
	Einsatzbereich		
	0 - 25 mbar 0 - 18 mbar	151 336 2676 2	
	0 - 60 mbar 0 - 45 mbar	151 336 2677 2	
	0 - 160 mbar 0 - 120 mbar	151 336 2678 2	
	0 - 400 mbar 0 - 300 mbar	151 336 2679 2	
	0 - 1,6 bar 0 - 1,2 bar	151 336 2680 2	
	0 - 2,5 bar 0 - 1,8 bar	151 336 2681 2	
	0 - 4,0 bar 0 - 3,0 bar	151 336 2682 2	
	0 - 6,0 bar 0 - 4,0 bar	151 336 2683 2	
	0 - 10,0 bar 0 - 7,5 bar	151 327 2618 2	
2.608	Manometer komplett für DMV (geschraubte Ausführung) + VEF-Ventil (WG 30+40 mit Drehzahl)		
	Einsatzbereich		
	0 - 25 mbar 0 - 18 mbar	151 336 2687 2	
	0 - 60 mbar 0 - 45 mbar	151 336 2688 2	
	0 - 160 mbar 0 - 120 mbar	151 336 2689 2	
	0 - 400 mbar 0 - 300 mbar	151 336 2690 2	
2.609	Manometer komplett für W-MF, *		
	Einsatzbereich		
	0 - 25 mbar 0 - 18 mbar	230 110 2602 2	
	0 - 60 mbar 0 - 45 mbar	230 110 2603 2	
	0 - 160 mbar 0 - 120 mbar	230 110 2604 2	
	0 - 400 mbar 0 - 300 mbar	230 110 2605 2	
	* Wenn zu diesem Aufbau bei WG-Brennern der GW-ÜB vorgesehen wird (Mehrpreis Brenner), dann ist die Verschraubung mit Nr. 230 210 26 04 7 mitzubestellen		
2.610	Manometer komplett G 1/4 für Einzelventile (MVD) oder Anschluss am Gasfilter		
	Einsatzbereich		
	0 - 25 mbar 0 - 18 mbar	151 327 2609 2	
	0 - 60 mbar 0 - 45 mbar	151 327 2640 2	
	0 - 160 mbar 0 - 120 mbar	151 327 2641 2	
	0 - 400 mbar 0 - 300 mbar	151 327 2642 2	
	0 - 1,6 bar 0 - 1,2 bar	151 330 2612 2	
	0 - 2,5 bar 0 - 1,8 bar	151 330 2613 2	
	0 - 4,0 bar 0 - 3,0 bar	151 330 2614 2	

No.	Description																																	
2.6	Pressure gauges and test burners																																	
2.601	<p>Pressure gauges, Casing Ø 100 mm connection pipe thread R 1/2"</p> <table border="0"> <tr> <td></td> <td>For supply</td> <td>pressure up to</td> </tr> <tr> <td>0 - 25 mbar</td> <td>0 - 18 mbar</td> <td>1.3 fold</td> </tr> <tr> <td>0 - 60 mbar</td> <td>0 - 45 mbar</td> <td>10 fold</td> </tr> <tr> <td>0 - 160 mbar</td> <td>0 - 120 mbar</td> <td>10 fold</td> </tr> <tr> <td>0 - 400 mbar</td> <td>0 - 300 mbar</td> <td>10 fold</td> </tr> <tr> <td>0 - 1.6 bar</td> <td>0 - 1.2 bar</td> <td>1.3 fold</td> </tr> <tr> <td>0 - 2.5 bar</td> <td>0 - 1.8 bar</td> <td>1.3 fold</td> </tr> <tr> <td>0 - 4.0 bar</td> <td>0 - 3.0 bar</td> <td>1.3 fold</td> </tr> <tr> <td>0 - 6.0 bar</td> <td>0 - 4.5 bar</td> <td>1.3 fold</td> </tr> <tr> <td>0 - 10.0 bar</td> <td>0 - 7.5 bar</td> <td>1.3 fold</td> </tr> <tr> <td>0 - 16.0 bar</td> <td>0 - 12 bar</td> <td>10 fold</td> </tr> </table>		For supply	pressure up to	0 - 25 mbar	0 - 18 mbar	1.3 fold	0 - 60 mbar	0 - 45 mbar	10 fold	0 - 160 mbar	0 - 120 mbar	10 fold	0 - 400 mbar	0 - 300 mbar	10 fold	0 - 1.6 bar	0 - 1.2 bar	1.3 fold	0 - 2.5 bar	0 - 1.8 bar	1.3 fold	0 - 4.0 bar	0 - 3.0 bar	1.3 fold	0 - 6.0 bar	0 - 4.5 bar	1.3 fold	0 - 10.0 bar	0 - 7.5 bar	1.3 fold	0 - 16.0 bar	0 - 12 bar	10 fold
	For supply	pressure up to																																
0 - 25 mbar	0 - 18 mbar	1.3 fold																																
0 - 60 mbar	0 - 45 mbar	10 fold																																
0 - 160 mbar	0 - 120 mbar	10 fold																																
0 - 400 mbar	0 - 300 mbar	10 fold																																
0 - 1.6 bar	0 - 1.2 bar	1.3 fold																																
0 - 2.5 bar	0 - 1.8 bar	1.3 fold																																
0 - 4.0 bar	0 - 3.0 bar	1.3 fold																																
0 - 6.0 bar	0 - 4.5 bar	1.3 fold																																
0 - 10.0 bar	0 - 7.5 bar	1.3 fold																																
0 - 16.0 bar	0 - 12 bar	10 fold																																
2.602	Push button valve , max. operating pressure 5 bar																																	
2.603	Pressure measuring nipple G 1/8 G 1/4																																	
2.604	Sealing G 1/8 G 1/4																																	
2.605	Double nozzle R1/4 with damping nozzle 0.3 Pressure gauge , complete with push button valve, line and screwed union suitable for installations to TRD 604 (Execution B, G 3/4 for flanged valve trains)																																	
2.606	<p>Pressure gauge complete (with additional GW...A6 or test burner)</p> <table border="0"> <tr> <td></td> <td>For supply</td> </tr> <tr> <td>0 - 25 mbar</td> <td>0 - 18 mbar</td> </tr> <tr> <td>0 - 60 mbar</td> <td>0 - 45 mbar</td> </tr> <tr> <td>0 - 160 mbar</td> <td>0 - 120 mbar</td> </tr> <tr> <td>0 - 400 mbar</td> <td>0 - 300 mbar</td> </tr> </table>		For supply	0 - 25 mbar	0 - 18 mbar	0 - 60 mbar	0 - 45 mbar	0 - 160 mbar	0 - 120 mbar	0 - 400 mbar	0 - 300 mbar																							
	For supply																																	
0 - 25 mbar	0 - 18 mbar																																	
0 - 60 mbar	0 - 45 mbar																																	
0 - 160 mbar	0 - 120 mbar																																	
0 - 400 mbar	0 - 300 mbar																																	
2.607	<p>Pressure gauge complete G1/4 for DMV flanged or connection to gas filter</p> <table border="0"> <tr> <td></td> <td>For supply</td> </tr> <tr> <td>0 - 25 mbar</td> <td>0 - 18 mbar</td> </tr> <tr> <td>0 - 60 mbar</td> <td>0 - 45 mbar</td> </tr> <tr> <td>0 - 160 mbar</td> <td>0 - 120 mbar</td> </tr> <tr> <td>0 - 400 mbar</td> <td>0 - 300 mbar</td> </tr> </table> <table border="0"> <tr> <td>0 - 1.6 bar</td> <td>0 - 1.2 bar</td> </tr> <tr> <td>0 - 2.5 bar</td> <td>0 - 1.8 bar</td> </tr> <tr> <td>0 - 4.0 bar</td> <td>0 - 3.0 bar</td> </tr> <tr> <td>0 - 6.0 bar</td> <td>0 - 4.0 bar</td> </tr> <tr> <td>0 - 10.0 bar</td> <td>0 - 7.5 bar</td> </tr> </table>		For supply	0 - 25 mbar	0 - 18 mbar	0 - 60 mbar	0 - 45 mbar	0 - 160 mbar	0 - 120 mbar	0 - 400 mbar	0 - 300 mbar	0 - 1.6 bar	0 - 1.2 bar	0 - 2.5 bar	0 - 1.8 bar	0 - 4.0 bar	0 - 3.0 bar	0 - 6.0 bar	0 - 4.0 bar	0 - 10.0 bar	0 - 7.5 bar													
	For supply																																	
0 - 25 mbar	0 - 18 mbar																																	
0 - 60 mbar	0 - 45 mbar																																	
0 - 160 mbar	0 - 120 mbar																																	
0 - 400 mbar	0 - 300 mbar																																	
0 - 1.6 bar	0 - 1.2 bar																																	
0 - 2.5 bar	0 - 1.8 bar																																	
0 - 4.0 bar	0 - 3.0 bar																																	
0 - 6.0 bar	0 - 4.0 bar																																	
0 - 10.0 bar	0 - 7.5 bar																																	
2.608	<p>Pressure gauge complete for DMV (screwed version) + VEF valve (WG 30+40 with speed control)</p> <table border="0"> <tr> <td></td> <td>For supply</td> </tr> <tr> <td>0 - 25 mbar</td> <td>0 - 18 mbar</td> </tr> <tr> <td>0 - 60 mbar</td> <td>0 - 45 mbar</td> </tr> <tr> <td>0 - 160 mbar</td> <td>0 - 120 mbar</td> </tr> <tr> <td>0 - 400 mbar</td> <td>0 - 300 mbar</td> </tr> </table>		For supply	0 - 25 mbar	0 - 18 mbar	0 - 60 mbar	0 - 45 mbar	0 - 160 mbar	0 - 120 mbar	0 - 400 mbar	0 - 300 mbar																							
	For supply																																	
0 - 25 mbar	0 - 18 mbar																																	
0 - 60 mbar	0 - 45 mbar																																	
0 - 160 mbar	0 - 120 mbar																																	
0 - 400 mbar	0 - 300 mbar																																	
2.609	<p>Pressure gauge complete for W-MF, *</p> <table border="0"> <tr> <td></td> <td>For supply</td> </tr> <tr> <td>0 - 25 mbar</td> <td>0 - 18 mbar</td> </tr> <tr> <td>0 - 60 mbar</td> <td>0 - 45 mbar</td> </tr> <tr> <td>0 - 160 mbar</td> <td>0 - 120 mbar</td> </tr> <tr> <td>0 - 400 mbar</td> <td>0 - 300 mbar</td> </tr> </table> <p>* If this configuration for WG burners is to be used with the GW-ÜB (additional burner price), the screwed union Order No. 230 210 26 04 7 should also be ordered</p>		For supply	0 - 25 mbar	0 - 18 mbar	0 - 60 mbar	0 - 45 mbar	0 - 160 mbar	0 - 120 mbar	0 - 400 mbar	0 - 300 mbar																							
	For supply																																	
0 - 25 mbar	0 - 18 mbar																																	
0 - 60 mbar	0 - 45 mbar																																	
0 - 160 mbar	0 - 120 mbar																																	
0 - 400 mbar	0 - 300 mbar																																	
2.610	<p>Pressure gauge complete G1/4 for single valves (MVD) or connection to gas filter</p> <table border="0"> <tr> <td></td> <td>For supply</td> </tr> <tr> <td>0 - 25 mbar</td> <td>0 - 18 mbar</td> </tr> <tr> <td>0 - 60 mbar</td> <td>0 - 45 mbar</td> </tr> <tr> <td>0 - 160 mbar</td> <td>0 - 120 mbar</td> </tr> <tr> <td>0 - 400 mbar</td> <td>0 - 300 mbar</td> </tr> </table> <table border="0"> <tr> <td>0 - 1.6 bar</td> <td>0 - 1.2 bar</td> </tr> <tr> <td>0 - 2.5 bar</td> <td>0 - 1.8 bar</td> </tr> <tr> <td>0 - 4.0 bar</td> <td>0 - 3.0 bar</td> </tr> </table>		For supply	0 - 25 mbar	0 - 18 mbar	0 - 60 mbar	0 - 45 mbar	0 - 160 mbar	0 - 120 mbar	0 - 400 mbar	0 - 300 mbar	0 - 1.6 bar	0 - 1.2 bar	0 - 2.5 bar	0 - 1.8 bar	0 - 4.0 bar	0 - 3.0 bar																	
	For supply																																	
0 - 25 mbar	0 - 18 mbar																																	
0 - 60 mbar	0 - 45 mbar																																	
0 - 160 mbar	0 - 120 mbar																																	
0 - 400 mbar	0 - 300 mbar																																	
0 - 1.6 bar	0 - 1.2 bar																																	
0 - 2.5 bar	0 - 1.8 bar																																	
0 - 4.0 bar	0 - 3.0 bar																																	

No.	Dénomination																																	
2.6	Manomètre et brûleur test																																	
2.601	<p>Manomètre corps ø 100 mm Raccord R 1/2" inférieur fois</p> <table border="0"> <tr> <td></td> <td>Plage d'utilisation</td> <td>surpression</td> </tr> <tr> <td>0 - 25 mbar</td> <td>0 - 18 mbar</td> <td>1,3 fois</td> </tr> <tr> <td>0 - 60 mbar</td> <td>0 - 45 mbar</td> <td>10 fois</td> </tr> <tr> <td>0 - 160 mbar</td> <td>0 - 120 mbar</td> <td>10 fois</td> </tr> <tr> <td>0 - 400 mbar</td> <td>0 - 300 mbar</td> <td>10 fois</td> </tr> <tr> <td>0 - 1,6 bar</td> <td>0 - 1,2 bar</td> <td>1,3 fois</td> </tr> <tr> <td>0 - 2,5 bar</td> <td>0 - 1,8 bar</td> <td>1,3 fois</td> </tr> <tr> <td>0 - 4,0 bar</td> <td>0 - 3,0 bar</td> <td>1,3 fois</td> </tr> <tr> <td>0 - 6,0 bar</td> <td>0 - 4,5 bar</td> <td>1,3 fois</td> </tr> <tr> <td>0 - 10,0 bar</td> <td>0 - 7,5 bar</td> <td>1,3 fois</td> </tr> <tr> <td>0 - 16,0 bar</td> <td>0 - 12 bar</td> <td>10 fois</td> </tr> </table>		Plage d'utilisation	surpression	0 - 25 mbar	0 - 18 mbar	1,3 fois	0 - 60 mbar	0 - 45 mbar	10 fois	0 - 160 mbar	0 - 120 mbar	10 fois	0 - 400 mbar	0 - 300 mbar	10 fois	0 - 1,6 bar	0 - 1,2 bar	1,3 fois	0 - 2,5 bar	0 - 1,8 bar	1,3 fois	0 - 4,0 bar	0 - 3,0 bar	1,3 fois	0 - 6,0 bar	0 - 4,5 bar	1,3 fois	0 - 10,0 bar	0 - 7,5 bar	1,3 fois	0 - 16,0 bar	0 - 12 bar	10 fois
	Plage d'utilisation	surpression																																
0 - 25 mbar	0 - 18 mbar	1,3 fois																																
0 - 60 mbar	0 - 45 mbar	10 fois																																
0 - 160 mbar	0 - 120 mbar	10 fois																																
0 - 400 mbar	0 - 300 mbar	10 fois																																
0 - 1,6 bar	0 - 1,2 bar	1,3 fois																																
0 - 2,5 bar	0 - 1,8 bar	1,3 fois																																
0 - 4,0 bar	0 - 3,0 bar	1,3 fois																																
0 - 6,0 bar	0 - 4,5 bar	1,3 fois																																
0 - 10,0 bar	0 - 7,5 bar	1,3 fois																																
0 - 16,0 bar	0 - 12 bar	10 fois																																
2.602	Robinet poussoir , pression de service max. 5 bar																																	
2.603	Raccord G 1/8 G 1/4																																	
2.604	Joint G 1/8 G 1/4																																	
2.605	Mamelon double R 1/4 avec diaphragme 0,3 Manomètre , complet avec robinet poussoir, manchon et raccord pour installations selon TRD 604 (exécution B, G 1/4 raccord sur filtre gaz et DMV sans GW)																																	
2.606	<p>Manomètre complet (pour GW...A6 supplémentaire ou brûleur test)</p> <table border="0"> <tr> <td></td> <td>Plage d'utilisation</td> </tr> <tr> <td>0 - 25 mbar</td> <td>0 - 18 mbar</td> </tr> <tr> <td>0 - 60 mbar</td> <td>0 - 45 mbar</td> </tr> <tr> <td>0 - 160 mbar</td> <td>0 - 120 mbar</td> </tr> <tr> <td>0 - 400 mbar</td> <td>0 - 300 mbar</td> </tr> </table>		Plage d'utilisation	0 - 25 mbar	0 - 18 mbar	0 - 60 mbar	0 - 45 mbar	0 - 160 mbar	0 - 120 mbar	0 - 400 mbar	0 - 300 mbar																							
	Plage d'utilisation																																	
0 - 25 mbar	0 - 18 mbar																																	
0 - 60 mbar	0 - 45 mbar																																	
0 - 160 mbar	0 - 120 mbar																																	
0 - 400 mbar	0 - 300 mbar																																	
2.607	<p>Manomètre complet G1/4 pour DMV à brides ou raccordement sur filtre gaz</p> <table border="0"> <tr> <td></td> <td>Plage d'utilisation</td> </tr> <tr> <td>0 - 25 mbar</td> <td>0 - 18 mbar</td> </tr> <tr> <td>0 - 60 mbar</td> <td>0 - 45 mbar</td> </tr> <tr> <td>0 - 160 mbar</td> <td>0 - 120 mbar</td> </tr> <tr> <td>0 - 400 mbar</td> <td>0 - 300 mbar</td> </tr> </table> <table border="0"> <tr> <td>0 - 1,6 bar</td> <td>0 - 1,2 bar</td> </tr> <tr> <td>0 - 2,5 bar</td> <td>0 - 1,8 bar</td> </tr> <tr> <td>0 - 4,0 bar</td> <td>0 - 3,0 bar</td> </tr> <tr> <td>0 - 6,0 bar</td> <td>0 - 4,0 bar</td> </tr> <tr> <td>0 - 10,0 bar</td> <td>0 - 7,5 bar</td> </tr> </table>		Plage d'utilisation	0 - 25 mbar	0 - 18 mbar	0 - 60 mbar	0 - 45 mbar	0 - 160 mbar	0 - 120 mbar	0 - 400 mbar	0 - 300 mbar	0 - 1,6 bar	0 - 1,2 bar	0 - 2,5 bar	0 - 1,8 bar	0 - 4,0 bar	0 - 3,0 bar	0 - 6,0 bar	0 - 4,0 bar	0 - 10,0 bar	0 - 7,5 bar													
	Plage d'utilisation																																	
0 - 25 mbar	0 - 18 mbar																																	
0 - 60 mbar	0 - 45 mbar																																	
0 - 160 mbar	0 - 120 mbar																																	
0 - 400 mbar	0 - 300 mbar																																	
0 - 1,6 bar	0 - 1,2 bar																																	
0 - 2,5 bar	0 - 1,8 bar																																	
0 - 4,0 bar	0 - 3,0 bar																																	
0 - 6,0 bar	0 - 4,0 bar																																	
0 - 10,0 bar	0 - 7,5 bar																																	
2.608	<p>Manomètre complet pour DMV (exécution à visser) + vanne VEF (WG 30+40 avec variateur de vitesse)</p> <table border="0"> <tr> <td></td> <td>Plage d'utilisation</td> </tr> <tr> <td>0 - 25 mbar</td> <td>0 - 18 mbar</td> </tr> <tr> <td>0 - 60 mbar</td> <td>0 - 45 mbar</td> </tr> <tr> <td>0 - 160 mbar</td> <td>0 - 120 mbar</td> </tr> <tr> <td>0 - 400 mbar</td> <td>0 - 300 mbar</td> </tr> </table>		Plage d'utilisation	0 - 25 mbar	0 - 18 mbar	0 - 60 mbar	0 - 45 mbar	0 - 160 mbar	0 - 120 mbar	0 - 400 mbar	0 - 300 mbar																							
	Plage d'utilisation																																	
0 - 25 mbar	0 - 18 mbar																																	
0 - 60 mbar	0 - 45 mbar																																	
0 - 160 mbar	0 - 120 mbar																																	
0 - 400 mbar	0 - 300 mbar																																	
2.609	<p>Manomètre complet pour W-MF, *</p> <table border="0"> <tr> <td></td> <td>Plage d'utilisation</td> </tr> <tr> <td>0 - 25 mbar</td> <td>0 - 18 mbar</td> </tr> <tr> <td>0 - 60 mbar</td> <td>0 - 45 mbar</td> </tr> <tr> <td>0 - 160 mbar</td> <td>0 - 120 mbar</td> </tr> <tr> <td>0 - 400 mbar</td> <td>0 - 300 mbar</td> </tr> </table> <p>* Si les brûleurs WG sont prévus avec GW-ÜB (plus-value brûleur) il faut également commander le raccord réf. 230 210 26 04</p>		Plage d'utilisation	0 - 25 mbar	0 - 18 mbar	0 - 60 mbar	0 - 45 mbar	0 - 160 mbar	0 - 120 mbar	0 - 400 mbar	0 - 300 mbar																							
	Plage d'utilisation																																	
0 - 25 mbar	0 - 18 mbar																																	
0 - 60 mbar	0 - 45 mbar																																	
0 - 160 mbar	0 - 120 mbar																																	
0 - 400 mbar	0 - 300 mbar																																	
2.610	<p>Manomètre complet G 1/4 pour vanne simple (MVD) ou raccordement sur filtre gaz</p> <table border="0"> <tr> <td></td> <td>Plage d'utilisation</td> </tr> <tr> <td>0 - 25 mbar</td> <td>0 - 18 mbar</td> </tr> <tr> <td>0 - 60 mbar</td> <td>0 - 45 mbar</td> </tr> <tr> <td>0 - 160 mbar</td> <td>0 - 120 mbar</td> </tr> <tr> <td>0 - 400 mbar</td> <td>0 - 300 mbar</td> </tr> </table> <table border="0"> <tr> <td>0 - 1,6 bar</td> <td>0 - 1,2 bar</td> </tr> <tr> <td>0 - 2,5 bar</td> <td>0 - 1,8 bar</td> </tr> <tr> <td>0 - 4,0 bar</td> <td>0 - 3,0 bar</td> </tr> </table>		Plage d'utilisation	0 - 25 mbar	0 - 18 mbar	0 - 60 mbar	0 - 45 mbar	0 - 160 mbar	0 - 120 mbar	0 - 400 mbar	0 - 300 mbar	0 - 1,6 bar	0 - 1,2 bar	0 - 2,5 bar	0 - 1,8 bar	0 - 4,0 bar	0 - 3,0 bar																	
	Plage d'utilisation																																	
0 - 25 mbar	0 - 18 mbar																																	
0 - 60 mbar	0 - 45 mbar																																	
0 - 160 mbar	0 - 120 mbar																																	
0 - 400 mbar	0 - 300 mbar																																	
0 - 1,6 bar	0 - 1,2 bar																																	
0 - 2,5 bar	0 - 1,8 bar																																	
0 - 4,0 bar	0 - 3,0 bar																																	

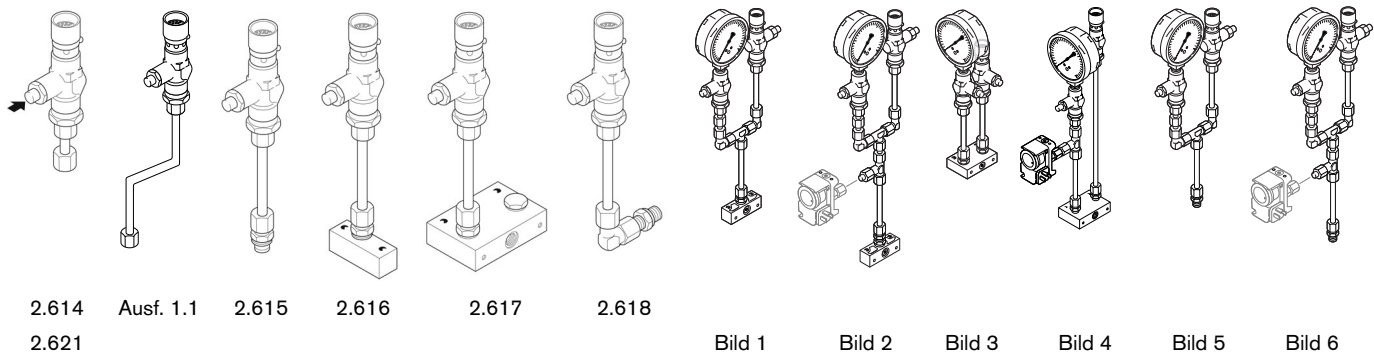

Nr.	Bezeichnung	Bestell-Nr. Order No. N° de commande	Preis EUR (o. MwSt.)
Montageteile			
2.611	zum Anbau von Manometer und Prüfbrenner am DMV geflanscht	151 336 2684 2	
2.612	zum Anbau von Manometer, Prüfbrenner und GW...A6 am DMV genipelt und geflanscht	151 336 2686 2	
2.613	zum Anbau von Manometer und Prüfbrenner an DMV geschraubt	151 336 2685 2	
2.614	Prüfbrenner EO-Anschluss ø 10/L bei zus. GW Prüfbrenner Ausf. 1.1 (Winkelausführung für evtl. Anpassungsmaßnahmen)	151 336 2675 2 150 808 2631 2	
2.615	Prüfbrenner G 1/4 10 x 100 mm DMV (geflossene Ausführung)	151 336 2673 2	
2.616	Prüfbrenner DMV, (geschraubte Ausführung) + VEF-Ventil	151 336 2674 2	
2.617	Prüfbrenner W-MF	230 110 2601 2	
2.618	Prüfbrenner G 1/4 Einzelventile (MVD) Gasdüsendurchmesser: 0,8 mm Umgebungstemperatur: -20 °C + 60 °C	151 327 2621 2	
2.619	Dichtung für Manometer 15 x 7,8 x 4,2	440 002	
2.620	Manometer 0-400 mbar mit Kugelhahn Ausf. A G1/4"	151 337 2609 2	
2.621	Prüfbrenner G 1/4 12 x 230 mm W-MF (geschraubte Ausführung)	250 104 2604 2	
Kombinationsbeispiele für Monarch und Industriebrenner Nachfolgende Teile sind zu verwenden:			
Geschraubte Ausführung (DMV) Baugr. 1 - 5 R 3/4 - R 2 und DMV R 2 neu			
Bild 1	Ausführung Manometer und Prüfbrenner (Pos. 2.606, 2.614 und 2.613)		
Bild 2	Ausführung Manometer und Prüfbrenner mit Anschluss für GW max. (Pos. 2.606, 2.614 und 2.612)		
Geschraubte Ausführung (W-MF)			
Bild 3	Ausführung Manometer und Prüfbrenner (Pos. 2.609 und 2.621)		
Bild 4	Ausführung Manometer und Prüfbrenner mit Anschluss für GW max. (Pos. 2.606 und 2.621)		
Geflossene Ausführung (DMV, VGD)			
Bild 5	Ausführung Manometer und Prüfbrenner (Pos. 2.606, 2.614 und 2.611)		
Bild 6	Ausführung Manometer und Prüfbrenner mit Anschluss für GW max. (Pos. 2.606, 2.614 und 2.612)		
ohne Bild	Prüfbrenner mit GW max. (GW max. Brennermehrpriis) (Pos. 2.614) Manometer mit GW max. (GW max. Brennermehrpriis) (Pos. 2.606)		
(siehe auch Technische Arbeitsmappe Register 7 Blatt 2.15 - 2.16.3)			

No.	Description	No.	Dénomination
	Connection parts		Éléments de montage
2.611	to fit pressure gauge and test burner to flanged DMV	2.611	pour montage de manomètre et brûleur test sur DMV à brides
2.612	to fit pressure gauge, test burner and GW...A6 to screwed and flanged DMV	2.612	pour montage manomètre, brûleur test et GW...A6 sur DMV fileté et à bride
2.613	to fit pressure gauge and test burner to screwed DMV	2.613	pour montage de manomètre et brûleur test sur DMV à visser
2.614	Test burner EO-connection Ø 10/L for add. GW Test burner vers. 1.1 (angle design for possible adaptation measures)	2.614	Brûleur test raccord à olive ø 10/L pour suppl. GW Brûleur test exéc. 1.1 (exécution coudée pour éventuelle adaptation)
2.615	Test burner G1/4 10 x 100 mm DMV-D (flanged version)	2.615	Brûleur test G 1/4 10 x 100 mm DMV-D (exécution à brides)
2.616	Test burner DMV(screwed version) + VEF valve	2.616	Brûleur test DMV (exécution à brides) + vanne VEF
2.617	Test burner W-MF	2.617	Brûleur test W-MF
2.618	Test burner G1/4 single valves (MVD) Gas nozzle diameter: 0.8 mm Ambient temperature: -20 °C +60 °C	2.618	Brûleur test G 1/4 vannes simples (MVD) Diamètre gicleur gaz : 0,8 mm Température ambiante : -20 °C + 60 °C
2.619	Seal for pressure gauge 15 x 7,8 x 4,2	2.619	Joint pour manomètre 15 x 7,8 x 4,2
2.620	Pressure gauge 0-400 mbar with ball valve vers. A G1/4"	2.620	Manomètre 0-400 mbar avec robinet exéc. A G1/4"
2.621	Test burner G 1/4 12 x 230 mm W-MF (flanged version)	2.621	Brûleur test G 1/4 12 x 230 mm W-MF (exécution à visser)
	Combination example for Monarch and Industrial burners The following parts are required:		Exemples de combinaisons pour brûleurs Monarch et industriels Les pièces ci-après doivent être utilisées :
	Screwed version (DMV) sizes 1 - 5 R 3/4 - R 2 and DMV R 2 new		Exécution à visser (DMV) gr. 1 - 5 R 3/4 - R 2 et DMV R 2 nouveau
Fig. 1	Pressure gauge and test burner (items 2.606, 2.614 and 2.613)	Image 1	Exécution manomètre et brûleur test (Pos. 2.606, 2.614 et 2.613)
Fig. 2	Pressure gauge and test burner with con. for high gas p.s. (items 2.606, 2.614 and 2.612)	Image 2	Exécution manomètre et brûleur test avec raccord pressostat max. (Pos. 2.606, 2.614 et 2.612)
	Screwed version (W-MF)		Exécution à visser (W-MF)
Fig. 3	Pressure gauge and test burner (items 2.609 and 2.621)	Image 3	Exécution manomètre et brûleur test (Pos. 2.609 et 2.621)
Fig. 4	Version pressure gauge and test burner with connection for GW max. (Pos. 2.606 and 2.621)	Image 4	Exécution manomètre et brûleur test avec raccordement pressostat max. (pos. 2.606 et 2.621)
	Flanged version (DMV, VGD)		Exécution à brides (DMV, VGD)
Fig. 5	Pressure gauge and test burner (items 2.606, 2.614 and 2.611)	Image 5	Exécution manomètre et brûleur test (Pos. 2.606, 2.614 et 2.611)
Fig. 6	Pressure gauge and test burner with con. for high gas p.s. (items 2.606, 2.614 and 2.612)	Image 6	Exécution manomètre et brûleur test avec raccord pressostat max. (Pos. 2.606, 2.614 et 2.612)
without picture	Test burner with GW max. (GW max. add. burner price) (Pos. 2.614) Pressure gauge with GW max. (GW max. add. burner price) (Pos. 2.606)	sans image	Brûleur test avec GW max. (plus-value brûleur GW max.) (pos. 2.614) Manomètre avec GW max. (plus-value brûleur GW max.) (pos. 2.606)
	(see also Technical Folder Register 7 sheet 2.15 - 2.16.3)		(voir également recueil de fiches techniques registre 7 feuil. 2.15 - 2.16.3)

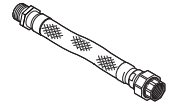
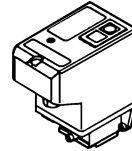
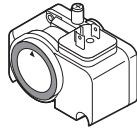
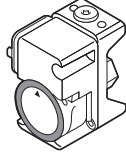
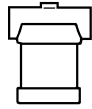
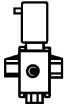
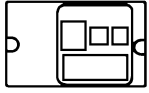

2.701

2.702

2.703

2.704

2.705

2.707

2.721

2.726

Nr.	Bezeichnung	Bestell-Nr. Order No. N° de commande	Preis EUR (o. MwSt.)
2.7	Dichtheitskontrolle W-DK 3/01 S 02		
2.701	Programmgeber W-DK3/01, 230V ± 15%, 50/60 Hz Programmgeber W-DK3/01, 110V, 50/60 Hz	109 000 0117 2 109 000 0097 2	
2.702	Magnetventil für Leckgas, stromlos offen		
	Typ DN Druckbereich		
	LGV 507/5, 230V G 3/4" 0,5 bar ohne Verschraubung	605 707	
	LGV 507/5, 110 V G 3/4" 0,5 bar ohne Verschraubung	605 700	
	zus. erforderlich bei Brennern <u>ohne</u> Zündgas bei LGV:		
	Zündgasflansch für DMV 507-520 + WMF-Ventile	605 232	
	Zündgasflansch für DMV 525	625 032	
	Leckgasventil- Verrohrungssets (Hauptgasventil bis LGV) (o. g. ZG-Flansche sind im Set beinhaltet)		
	Set für DMV 507-520 + WMF-Ventile	250 204 2601 0	
	Set für DMV 525	250 204 2603 0	
	Set für DMV geflanscht + VDG-Ventile	250 204 2602 0	
2.703	Dichtheitsanzeigergerät, G 3/4 ohne Glyzerinfüllung	151 327 8501 0	
2.704	Druckwächter GW 50 A6/1 5 - 50 mbar (für MV, Einzelventile) GW 150 A6/1 10 - 150 mbar (für MV, Einzelventile) GW 500 A6/1 100 - 500 mbar (für MV, Einzelventile)	691 381 691 382 691 383	
2.705	Druckwächter GW 50 A5/1 5 - 50 mbar (für DMV+VGD) GW 150 A5/1 10 - 150 mbar (für DMV+VGD) GW 500 A5/1 100 - 500 mbar (für DMV+VGD)	691 378 691 379 691 380	
2.706	GW-Stecker, 4-polig (für A5/1 u. A6/1)	217 304 2602 2	
2.707	Doppelnippel G 114" x 50 für Druckwächter A6/1	139 000 2601 7	
2.708	Montageplatten-Set (o. Bild) für W-DK 3/01 für DMV R 3/4 - R2 (Größe 1 - 5) und W-MF R 3/4 - R 1 1/2 (Größe 7 - 11) für DMV DN 80 - DN 100 + VGD DN 125 + DN 40/11, DN 50/11 für DMV 525 (R 2) für DMV DN 65 (DMV 5065/11 + /12) für VGD DN 150	109 000 0233 2 109 000 0234 2 109 000 0239 2 109 000 0240 2 109 000 0244 2	
2.720	Dichtheitskontrolle VPS 504 für DMV-Ventile (mit 2 O-Ringen und 4 Befestigungsschrauben)		
2.721	Dichtheitskontrolle VPS 504, S 03 mit Kabel 850 mm und 7-pol. Stecker, für WG-Brenner, CE-0085 AP 0168 230-240 V, 50Hz, IP54 110-120 V, 50Hz, IP54 230-240 V, 50Hz, IP54 (Flüssiggas) 110 V, 60 Hz 220 V, 60 Hz	605 581 605 586 605 582 605 587 605 583	
2.722	Dichtheitskontrolle VPS 504, S 04 mit Klemmanschluss, für G- und WK-Brenner, CE-0085 AP 0168 230-240 V, 50Hz, IP54 110-120 V, 50Hz, IP54 230-240 V, 50Hz, IP54 (Flüssiggas) 220V, 60Hz 110 V, 60 Hz 220 V, 60 Hz (Flüssiggas)	605 580 605 588 605 584 605 585 605 589 605 590	
	Adapter-Set für:		
2.723	DMV	605 251	
2.724	VPS 504	605 250	
2.725	W-MF	605 252	
	Gasschläuche		
2.726	Flexible Gasschläuche für WG-Brenner (Innen-/Außengewinde PN 1 bar)		
	Gasschlauch 1/2" x 500 mm	491 252	
	1/2" x 1000 mm	491 253	
	3/4" x 500 mm	491 254	
	3/4" x 1000 mm	491 255	
	1" x 500 mm	491 256	
	1" x 1000 mm	491 257	
	1 1/2" x 500 mm	491 258	
	1 1/2" x 1000 mm	491 259	
	2" x 500 mm	491 260	
	2" x 1000 mm	491 261	

No.	Description
2.7	Valve proving W-DK 3/01 S 02
2.701	Programmer W-DK3/01, 230V ± 15%, 50/60Hz Programmer W-DK3/01, 110V, 50/60 Hz
2.702	Solenoid vent valve , normally open Type DN Pressure range LGV 507/5, 230V G 3/4" 0.5 bar without screwed union LGV 507/5, 110 V G 3/4" 0.5 bar without screwed union add. required for burners <u>without</u> ignition gas with LGV: Ignition gas valve for DMV 507-520 + WMF valves Ignition gas valve for DMV 525 Leakage gas valve piping set (main gas valve with LGV) (ign. gas valves above are included in the set) Set for DMV 507-520 + WMF valves Set for DMV 525 Set for DMV flanged + VDG valves
2.703	Bubble jar , R 3/4 without glycerin filling
2.704	Pressure switch GW 50 A6/1 5 - 50 mbar (for single valves MV) GW 150 A6/1 10 - 150 mbar (for single valves MV) GW 500 A6/1 100 - 500 mbar (for single valves MV)
2.705	Pressure switch GW 50 A5/1 5 - 50 mbar (for DMV+VGD) GW 150 A5/1 10 - 150 mbar (for DMV+VGD) GW 500 A5/1 100 - 500 mbar (for DMV+VGD)
2.706	Gas pressure switch plug , 4 pole (for A5/1 and A6/1)
2.707	Double nipple G 114" x 50 for pressure switch A6/1
2.708	Mounting plate set (without picture) for W-DK3/01 for DMV R 3/4 - R2 (size 1 - 5) and W-MF R 3/4 - R 1 1/2 (size 7 - 11) for DMV DN 80 - DN 100 + VGD DN 125 + DN 40/11 DN 50/11 for DMV 525 (R 2) for DMV DN 65 (DMV 5065/11 + /12) for VGD DN 150
2.720	Valve proving VPS 504 for DMV valves (with two O rings and four fixing screws)
2.721	Valve proving set VPS 504 S 03 with cable 850 mm and 7 pole plug, for WG burners, CE 0085 AP 0168 230-240 V, 50Hz, IP54 110-120 V, 50Hz, IP54 230-240 V, 50Hz, IP54 (LPG) 110 V, 60 Hz 220 V, 60 Hz (LPG)
2.722	Valve proving set VPS 504 S 04 with terminal connection, for G- and WK burners, CE-0085 AP 0168 230-240 V, 50Hz, IP54 110-120 V, 50Hz, IP54 230-240 V, 50Hz, IP54 (LPG) 220V, 60Hz 110 V, 60 Hz 220 V, 60 Hz (LPG) Adaptor set for 2.723 DMV 2.724 VPS 504 2.725 W-FM
	Gas hoses
2.726	Flexible gas hoses for WG burners (inner/outer thread PN 1 bar) Gas hose 1/2" x 500 mm 1/2" x 1000 mm 3/4" x 500 mm 3/4" x 1000 mm 1" x 500 mm 1" x 1000 mm 1 1/2" x 500 mm 1 1/2" x 1000 mm 2" x 500 mm 2" x 1000 mm

No.	Dénomination
2.7	Contrôle d'étanchéité W-DK 3/01 S 02
2.701	Programmeur W-DK3/01, 230V ± 15%, 50/60 Hz Programmeur W-DK3/01, 110V, 50/60 Hz
2.702	Vanne magnétique pour mise à l'air libre , ouverte hors tension Type DN Plage de pression LGV 507/5, 230V G 3/4" 0,5 bar sans raccord LGV 507/5, 110 V G 3/4" 0,5 bar sans raccord supplément nécessaire pour brûleurs <u>sans</u> vanne d'allumage avec vanne de mise à l'air libre : Bride d'allumage gaz pour DMV 507-520 + vannes WMF Bride d'allumage gaz pour DMV 525 Kit vanne de mise à l'air libre (vanne gaz principale jusqu'à vanne mise à l'air libre) (les brides d'allumage gaz précitées sont comprises dans le set) Set pour DMV 507-520 + vannes WMF Set pour DMV 525 Set pour DMV à brides + vannes VDG
2.703	Indicteur visuel de fuite , G 3/4 sans glycérine
2.704	Pressostat GW 50 A6/1 5 - 50 mbar (pour vannes uniques) GW 150 A6/1 10 - 150 mbar (pour vannes uniques) GW 500 A6/1 100 - 500 mbar (pour vannes uniques)
2.705	Pressostat GW 50 A5/1 5 - 50 mbar (pour DMV+VGD) GW 150 A5/1 10 - 150 mbar (pour DMV+VGD) GW 500 A5/1 100 - 500 mbar (pour DMV+VGD)
2.706	Connecteur , 4 pôles (pour A5/1 et A6/1)
2.707	Mamelon double G 114" x 50 pour pressostat A6/1
2.708	Ensemble plaque de montage (sans photo) pour W-DK 3/01 pour DMV R 3/4 - R2 (taille 1 - 5) et W-MF R 3/4 - R 1 1/2 (taille 7 - 11) pour DMV DN 80 - DN 100 + VGD DN 125 + DN 40/11 DN 50/11 pour DMV 525 (R 2) pour DMV DN 65 (DMV 5065/11 + /12) pour VGD DN 150
2.720	Contrôle d'étanchéité VPS 504 pour vannes DMV (avec 2 joints toriques et 4 vis de fixation)
2.721	Contrôleur d'étanchéité VPS 504, S 03 avec câble 850 mm et connecteur 7 pôles, pour brûleurs WG, CE-0085 AP 0168 230-240 V, 50Hz, IP54 110-120 V, 50Hz, IP54 230-240 V, 50Hz, IP54 (GPL) 110 V, 60 Hz 220 V, 60 Hz (GPL)
2.722	Contrôleur d'étanchéité VPS 504, S 04 avec raccords, pour brûleurs G et WK, CE-0085 AP 0168 230-240 V, 50Hz, IP54 110-120 V, 50Hz, IP54 230-240 V, 50Hz, IP54 (GPL) 220V, 60Hz 110 V, 60 Hz 220 V, 60 Hz (GPL) Ensemble d'adaptation pour 2.723 DMV 2.724 VPS 504 2.725 W-FM
	Flexible pour brûleur gaz
2.726	Flexible pour brûleur gaz WG (filetage intérieur/extérieur PN 1 Bar) Flexible gaz 1/2" x 500 mm 1/2" x 1000 mm 3/4" x 500 mm 3/4" x 1000 mm 1" x 500 mm 1" x 1000 mm 1 1/2" x 500 mm 1 1/2" x 1000 mm 2" x 500 mm 2" x 1000 mm

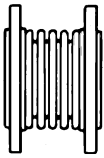

2.801

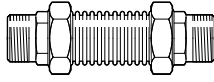

2.802

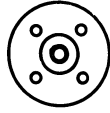

2.803



2.804

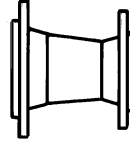

2.805

Nr.	Bezeichnung	Bestell-Nr. Order No. N° de commande	Preis EUR (o. MwSt.)
2.8	Kompensatoren und Verbindungsteile		
2.801	Axial-Kompensator , geflanscht: DIN 2633, PN10		
	Typ DN		
	ALN 10.0020.018.0 20	151 327 2662 2	
	ALN 10.0025.022.0 25	151 327 2663 2	
	ALN 10.0040.030.0 40	151 327 2664 2	
	ALN 10.0050.028.0 50	151 327 2665 2	
	ALN 10.0065.020.0 65	151 327 2666 2	
	ALN 10.0080.032.0 80	151 329 2694 2	
	ALN 10.0100.028.0 100	151 327 2668 2	
	ABN 10.0125.035.0 125	151 327 2669 2	
	ABN 10.0150.032.0 150	151 328 2623 2	
	Lieferumfang: Schrauben, Muttern und Dichtung für 1 Trennstelle		
2.802	Axial-Kompensator geschraubt (Außengewinde)		
	Typ PN Länge		
	AGB 10.0020.028.0 R 3/4" 10 173 mm	454 354	
	AGB 10.0025.030.0 R 1" 10 194 mm	454 355	
	AGB 10.0040.034.0 R 1 1/2" 10 240 mm	454 356	
	AGB 10.0050.040.0 R 2" 10 270 mm	454 357	
	(Dichtungen siehe Pos. 2.823)		
2.803	Gewindeflansch , DIN EN 1092-1		
	DN PN		
	15 40	452 916	
	20 40	452 924	
	25 40	452 925	
	40 40	452 920	
	50 16	452 921	
	65 16	452 922	
	80 16	452 923	
2.804	Vorschweißflansch , DIN EN 1092-1		
	DN PN		
	20 40	452 940	
	25 40	452 941	
	40 40	452 942	
	50 40	452 936	
	65 40	452 910	
	80 16	452 911	
	100 16	452 913	
	125 16	452 914	
	150 16	452 918	
2.805	Übergangsflansch, konzentrisch, aus Stahl und GGG (max. Betriebsdruck PN16) Flanschanschluss: DIN 2633, PN16		
	DN ca. Länge mm Werkstoff		
	25 x 40 150 Stahl	151 327 2671 2	
	25 x 50 165 Stahl	151 327 2680 2	
	25 x 65 173 Stahl	151 330 2620 2	
	25 x 80 182 Stahl	151 330 2621 2	
	40 x 50 200 GGG	151 330 2625 2	
	50 x 65 200 GGG	151 327 2682 2	
	50 x 80 200 GGG	151 329 2689 2	
	50 x 100 200 GGG	151 327 2644 2	
	65 x 80 200 GGG	151 330 2608 2	
	80 x 100 200 GGG	151 329 2690 2	
	80 x 125 200 GGG	151 329 2691 2	
	80 x 150 200 GGG	151 330 2622 2	
	100 x 125 200 GGG	151 327 2689 2	
	100 x 150 200 GGG	151 328 2626 2	
	125 x 150 200 GGG	151 330 2623 2	
	Lieferumfang: Schrauben, Muttern und Dichtringe für 2 Trennstellen		

No.	Description																																																
2.8	Compensators and connection parts																																																
2.801	Axial compensator , flanged: DIN 2633, nominal pressure PN10, <table border="0"> <tr> <td>Type</td> <td>DN</td> </tr> <tr> <td>ALN 10.0020.018.0</td> <td>20</td> </tr> <tr> <td>ALN 10.0025.022.0</td> <td>25</td> </tr> <tr> <td>ALN 10.0040.030.0</td> <td>40</td> </tr> <tr> <td>ALN 10.0050.028.0</td> <td>50</td> </tr> <tr> <td>ALN 10.0065.020.0</td> <td>65</td> </tr> <tr> <td>ALN 10.0080.032.0</td> <td>80</td> </tr> <tr> <td>ALN 10.0100.028.0</td> <td>100</td> </tr> <tr> <td>ABN 10.0125.035.0</td> <td>125</td> </tr> <tr> <td>ABN 10.0150.032.0</td> <td>150</td> </tr> </table> Included in delivery: Screws, nuts and sealing for 1 connection point	Type	DN	ALN 10.0020.018.0	20	ALN 10.0025.022.0	25	ALN 10.0040.030.0	40	ALN 10.0050.028.0	50	ALN 10.0065.020.0	65	ALN 10.0080.032.0	80	ALN 10.0100.028.0	100	ABN 10.0125.035.0	125	ABN 10.0150.032.0	150																												
Type	DN																																																
ALN 10.0020.018.0	20																																																
ALN 10.0025.022.0	25																																																
ALN 10.0040.030.0	40																																																
ALN 10.0050.028.0	50																																																
ALN 10.0065.020.0	65																																																
ALN 10.0080.032.0	80																																																
ALN 10.0100.028.0	100																																																
ABN 10.0125.035.0	125																																																
ABN 10.0150.032.0	150																																																
2.802	Axial compensator screwed (outer thread) <table border="0"> <tr> <td>Type</td> <td>PN</td> <td>Length</td> </tr> <tr> <td>AGB 10.0020.028.0 R 3/4"</td> <td>10</td> <td>173 mm</td> </tr> <tr> <td>AGB 10.0025.030.0 R 1"</td> <td>10</td> <td>194 mm</td> </tr> <tr> <td>AGB 10.0040.034.0 R 1 1/2"</td> <td>10</td> <td>240 mm</td> </tr> <tr> <td>AGB 10.0050.040.0 R 2"</td> <td>10</td> <td>270 mm</td> </tr> </table> (Gaskets see Pos. 2.823)	Type	PN	Length	AGB 10.0020.028.0 R 3/4"	10	173 mm	AGB 10.0025.030.0 R 1"	10	194 mm	AGB 10.0040.034.0 R 1 1/2"	10	240 mm	AGB 10.0050.040.0 R 2"	10	270 mm																																	
Type	PN	Length																																															
AGB 10.0020.028.0 R 3/4"	10	173 mm																																															
AGB 10.0025.030.0 R 1"	10	194 mm																																															
AGB 10.0040.034.0 R 1 1/2"	10	240 mm																																															
AGB 10.0050.040.0 R 2"	10	270 mm																																															
2.803	Threaded flange , DIN EN 1092-1 <table border="0"> <tr> <td></td> <td>DN</td> <td>PN</td> </tr> <tr> <td></td> <td>15</td> <td>40</td> </tr> <tr> <td></td> <td>20</td> <td>40</td> </tr> <tr> <td></td> <td>25</td> <td>40</td> </tr> <tr> <td></td> <td>40</td> <td>40</td> </tr> <tr> <td></td> <td>50</td> <td>16</td> </tr> <tr> <td></td> <td>65</td> <td>16</td> </tr> <tr> <td></td> <td>80</td> <td>16</td> </tr> </table>		DN	PN		15	40		20	40		25	40		40	40		50	16		65	16		80	16																								
	DN	PN																																															
	15	40																																															
	20	40																																															
	25	40																																															
	40	40																																															
	50	16																																															
	65	16																																															
	80	16																																															
2.804	Welded flange , DIN EN 1092-1 <table border="0"> <tr> <td></td> <td>DN</td> <td>PN</td> </tr> <tr> <td></td> <td>20</td> <td>40</td> </tr> <tr> <td></td> <td>25</td> <td>40</td> </tr> <tr> <td></td> <td>40</td> <td>40</td> </tr> <tr> <td></td> <td>50</td> <td>40</td> </tr> <tr> <td></td> <td>65</td> <td>40</td> </tr> <tr> <td></td> <td>80</td> <td>16</td> </tr> <tr> <td></td> <td>100</td> <td>16</td> </tr> <tr> <td></td> <td>125</td> <td>16</td> </tr> <tr> <td></td> <td>150</td> <td>16</td> </tr> </table>		DN	PN		20	40		25	40		40	40		50	40		65	40		80	16		100	16		125	16		150	16																		
	DN	PN																																															
	20	40																																															
	25	40																																															
	40	40																																															
	50	40																																															
	65	40																																															
	80	16																																															
	100	16																																															
	125	16																																															
	150	16																																															
2.805	Reducing flanges, concentric, of steel and GGG (max. operating pressure PN16) flanged: DIN 2633, PN16 <table border="0"> <tr> <td>DN</td> <td>approx. length mm</td> <td>Material</td> </tr> <tr> <td>25 x 40</td> <td>150</td> <td>Steel</td> </tr> <tr> <td>25 x 50</td> <td>165</td> <td>Steel</td> </tr> <tr> <td>25 x 65</td> <td>173</td> <td>Steel</td> </tr> <tr> <td>25 x 80</td> <td>182</td> <td>Steel</td> </tr> <tr> <td>40 x 50</td> <td>200</td> <td>GGG</td> </tr> <tr> <td>50 x 65</td> <td>200</td> <td>GGG</td> </tr> <tr> <td>50 x 80</td> <td>200</td> <td>GGG</td> </tr> <tr> <td>50 x 100</td> <td>200</td> <td>GGG</td> </tr> <tr> <td>65 x 80</td> <td>200</td> <td>GGG</td> </tr> <tr> <td>80 x 100</td> <td>200</td> <td>GGG</td> </tr> <tr> <td>80 x 125</td> <td>200</td> <td>GGG</td> </tr> <tr> <td>80 x 150</td> <td>200</td> <td>GGG</td> </tr> <tr> <td>100 x 125</td> <td>200</td> <td>GGG</td> </tr> <tr> <td>100 x 150</td> <td>200</td> <td>GGG</td> </tr> <tr> <td>125 x 150</td> <td>200</td> <td>GGG</td> </tr> </table> Included in delivery: Screws, nuts, sealing rings for 2 connection points	DN	approx. length mm	Material	25 x 40	150	Steel	25 x 50	165	Steel	25 x 65	173	Steel	25 x 80	182	Steel	40 x 50	200	GGG	50 x 65	200	GGG	50 x 80	200	GGG	50 x 100	200	GGG	65 x 80	200	GGG	80 x 100	200	GGG	80 x 125	200	GGG	80 x 150	200	GGG	100 x 125	200	GGG	100 x 150	200	GGG	125 x 150	200	GGG
DN	approx. length mm	Material																																															
25 x 40	150	Steel																																															
25 x 50	165	Steel																																															
25 x 65	173	Steel																																															
25 x 80	182	Steel																																															
40 x 50	200	GGG																																															
50 x 65	200	GGG																																															
50 x 80	200	GGG																																															
50 x 100	200	GGG																																															
65 x 80	200	GGG																																															
80 x 100	200	GGG																																															
80 x 125	200	GGG																																															
80 x 150	200	GGG																																															
100 x 125	200	GGG																																															
100 x 150	200	GGG																																															
125 x 150	200	GGG																																															

No.	Dénomination																																																
2.8	Compensateurs et éléments de raccordement																																																
2.801	Compensateur axial , à brides : DIN 2633, PN10 <table border="0"> <tr> <td>Type</td> <td>DN</td> </tr> <tr> <td>ALN 10.0020.018.0</td> <td>20</td> </tr> <tr> <td>ALN 10.0025.022.0</td> <td>25</td> </tr> <tr> <td>ALN 10.0040.030.0</td> <td>40</td> </tr> <tr> <td>ALN 10.0050.028.0</td> <td>50</td> </tr> <tr> <td>ALN 10.0065.020.0</td> <td>65</td> </tr> <tr> <td>ALN 10.0080.032.0</td> <td>80</td> </tr> <tr> <td>ALN 10.0100.028.0</td> <td>100</td> </tr> <tr> <td>ABN 10.0125.035.0</td> <td>125</td> </tr> <tr> <td>ABN 10.0150.032.0</td> <td>150</td> </tr> </table> La fourniture comprend : vis, écrous et joints pour une liaison	Type	DN	ALN 10.0020.018.0	20	ALN 10.0025.022.0	25	ALN 10.0040.030.0	40	ALN 10.0050.028.0	50	ALN 10.0065.020.0	65	ALN 10.0080.032.0	80	ALN 10.0100.028.0	100	ABN 10.0125.035.0	125	ABN 10.0150.032.0	150																												
Type	DN																																																
ALN 10.0020.018.0	20																																																
ALN 10.0025.022.0	25																																																
ALN 10.0040.030.0	40																																																
ALN 10.0050.028.0	50																																																
ALN 10.0065.020.0	65																																																
ALN 10.0080.032.0	80																																																
ALN 10.0100.028.0	100																																																
ABN 10.0125.035.0	125																																																
ABN 10.0150.032.0	150																																																
2.802	Compensateur axial à visser (diamètre extérieur) <table border="0"> <tr> <td>Type</td> <td>PN</td> <td>Longueur</td> </tr> <tr> <td>AGB 10.0020.028.0 R 3/4"</td> <td>10</td> <td>173 mm</td> </tr> <tr> <td>AGB 10.0025.030.0 R 1"</td> <td>10</td> <td>194 mm</td> </tr> <tr> <td>AGB 10.0040.034.0 R 1 1/2"</td> <td>10</td> <td>240 mm</td> </tr> <tr> <td>AGB 10.0050.040.0 R 2"</td> <td>10</td> <td>270 mm</td> </tr> </table> (pour les joints voir pos. 2.823)	Type	PN	Longueur	AGB 10.0020.028.0 R 3/4"	10	173 mm	AGB 10.0025.030.0 R 1"	10	194 mm	AGB 10.0040.034.0 R 1 1/2"	10	240 mm	AGB 10.0050.040.0 R 2"	10	270 mm																																	
Type	PN	Longueur																																															
AGB 10.0020.028.0 R 3/4"	10	173 mm																																															
AGB 10.0025.030.0 R 1"	10	194 mm																																															
AGB 10.0040.034.0 R 1 1/2"	10	240 mm																																															
AGB 10.0050.040.0 R 2"	10	270 mm																																															
2.803	Bride taraudée , DIN EN 1092-1 <table border="0"> <tr> <td></td> <td>DN</td> <td>PN</td> </tr> <tr> <td></td> <td>15</td> <td>40</td> </tr> <tr> <td></td> <td>20</td> <td>40</td> </tr> <tr> <td></td> <td>25</td> <td>40</td> </tr> <tr> <td></td> <td>40</td> <td>40</td> </tr> <tr> <td></td> <td>50</td> <td>16</td> </tr> <tr> <td></td> <td>65</td> <td>16</td> </tr> <tr> <td></td> <td>80</td> <td>16</td> </tr> </table>		DN	PN		15	40		20	40		25	40		40	40		50	16		65	16		80	16																								
	DN	PN																																															
	15	40																																															
	20	40																																															
	25	40																																															
	40	40																																															
	50	16																																															
	65	16																																															
	80	16																																															
2.804	Bride à souder , DIN EN 1092-1 <table border="0"> <tr> <td></td> <td>DN</td> <td>PN</td> </tr> <tr> <td></td> <td>20</td> <td>40</td> </tr> <tr> <td></td> <td>25</td> <td>40</td> </tr> <tr> <td></td> <td>40</td> <td>40</td> </tr> <tr> <td></td> <td>50</td> <td>40</td> </tr> <tr> <td></td> <td>65</td> <td>40</td> </tr> <tr> <td></td> <td>80</td> <td>16</td> </tr> <tr> <td></td> <td>100</td> <td>16</td> </tr> <tr> <td></td> <td>125</td> <td>16</td> </tr> <tr> <td></td> <td>150</td> <td>16</td> </tr> </table>		DN	PN		20	40		25	40		40	40		50	40		65	40		80	16		100	16		125	16		150	16																		
	DN	PN																																															
	20	40																																															
	25	40																																															
	40	40																																															
	50	40																																															
	65	40																																															
	80	16																																															
	100	16																																															
	125	16																																															
	150	16																																															
2.805	Bride de réduction, concentrique, en acier et GGG (pression de service max. PN16) Raccordement par brides : DIN 2633, PN16 <table border="0"> <tr> <td>DN</td> <td>Longueur env. mm</td> <td>Werkstoff</td> </tr> <tr> <td>25 x 40</td> <td>150</td> <td>Stahl</td> </tr> <tr> <td>25 x 50</td> <td>165</td> <td>Stahl</td> </tr> <tr> <td>25 x 65</td> <td>173</td> <td>Stahl</td> </tr> <tr> <td>25 x 80</td> <td>182</td> <td>Stahl</td> </tr> <tr> <td>40 x 50</td> <td>200</td> <td>GGG</td> </tr> <tr> <td>50 x 65</td> <td>200</td> <td>GGG</td> </tr> <tr> <td>50 x 80</td> <td>200</td> <td>GGG</td> </tr> <tr> <td>50 x 100</td> <td>200</td> <td>GGG</td> </tr> <tr> <td>65 x 80</td> <td>200</td> <td>GGG</td> </tr> <tr> <td>80 x 100</td> <td>200</td> <td>GGG</td> </tr> <tr> <td>80 x 125</td> <td>200</td> <td>GGG</td> </tr> <tr> <td>80 x 150</td> <td>200</td> <td>GGG</td> </tr> <tr> <td>100 x 125</td> <td>200</td> <td>GGG</td> </tr> <tr> <td>100 x 150</td> <td>200</td> <td>GGG</td> </tr> <tr> <td>125 x 150</td> <td>200</td> <td>GGG</td> </tr> </table> La fourniture comprend : vis, écrous et joints pour 2 liaisons	DN	Longueur env. mm	Werkstoff	25 x 40	150	Stahl	25 x 50	165	Stahl	25 x 65	173	Stahl	25 x 80	182	Stahl	40 x 50	200	GGG	50 x 65	200	GGG	50 x 80	200	GGG	50 x 100	200	GGG	65 x 80	200	GGG	80 x 100	200	GGG	80 x 125	200	GGG	80 x 150	200	GGG	100 x 125	200	GGG	100 x 150	200	GGG	125 x 150	200	GGG
DN	Longueur env. mm	Werkstoff																																															
25 x 40	150	Stahl																																															
25 x 50	165	Stahl																																															
25 x 65	173	Stahl																																															
25 x 80	182	Stahl																																															
40 x 50	200	GGG																																															
50 x 65	200	GGG																																															
50 x 80	200	GGG																																															
50 x 100	200	GGG																																															
65 x 80	200	GGG																																															
80 x 100	200	GGG																																															
80 x 125	200	GGG																																															
80 x 150	200	GGG																																															
100 x 125	200	GGG																																															
100 x 150	200	GGG																																															
125 x 150	200	GGG																																															

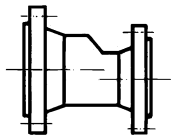

2.806

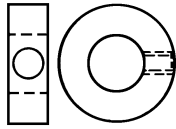

2.807

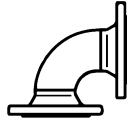

2.808

Nr.	Bezeichnung	Bestell-Nr. Order No. N° de commande	Preis EUR (o. MwSt.)																																																																																																
2.806	Übergangsflansch, exzentrisch, aus Aluminium (max. Betriebsdruck 3 bar) geflanscht: DIN 2633, PN16, nicht für Einbau vor dem Hochdruckregler																																																																																																		
	<table border="0"> <thead> <tr> <th>DN</th> <th>ca. Länge mm</th> <th>Mittensversatz mm</th> <th></th> </tr> </thead> <tbody> <tr><td>25 x 40</td><td>144</td><td>7,5</td><td>151 329 2630 2</td></tr> <tr><td>25 x 50</td><td>159</td><td>12,5</td><td>151 329 2631 2</td></tr> <tr><td>25 x 65</td><td>172</td><td>20,0</td><td>151 329 2632 2</td></tr> <tr><td>25 x 80</td><td>177</td><td>27,5</td><td>151 329 2683 2</td></tr> <tr><td colspan="4"> </td></tr> <tr><td>40 x 50</td><td>163</td><td>5,0</td><td>151 329 2634 2</td></tr> <tr><td>40 x 65</td><td>177</td><td>12,5</td><td>151 329 2635 2</td></tr> <tr><td>40 x 80</td><td>181</td><td>20,0</td><td>151 329 2684 2</td></tr> <tr><td>40 x 100</td><td>195</td><td>31,0</td><td>151 329 2637 2</td></tr> <tr><td colspan="4"> </td></tr> <tr><td>50 x 65</td><td>180</td><td>7,5</td><td>151 329 2638 2</td></tr> <tr><td>50 x 80</td><td>185</td><td>15,0</td><td>151 329 2685 2</td></tr> <tr><td>50 x 100</td><td>197</td><td>26,0</td><td>151 329 2640 2</td></tr> <tr><td colspan="4"> </td></tr> <tr><td>65 x 80</td><td>185</td><td>7,5</td><td>151 329 2686 2</td></tr> <tr><td>65 x 100</td><td>197</td><td>18,5</td><td>151 329 2642 2</td></tr> <tr><td>65 x 125</td><td>227</td><td>31,0</td><td>151 329 2643 2</td></tr> <tr><td>80 x 100</td><td>207</td><td>11,0</td><td>151 329 2687 2</td></tr> <tr><td>80 x 125</td><td>232</td><td>23,5</td><td>151 329 2688 2</td></tr> <tr><td colspan="4"> </td></tr> <tr><td>100 x 125</td><td>234</td><td>12,5</td><td>151 329 2646 2</td></tr> <tr><td>100 x 150</td><td>247</td><td>26,5</td><td>151 329 2647 2</td></tr> <tr><td>125 x 150</td><td>250</td><td>14,0</td><td>151 329 2648 2</td></tr> </tbody> </table> Lieferumfang: Schrauben, Muttern und Dichtringe für 2 Trennstellen	DN	ca. Länge mm	Mittensversatz mm		25 x 40	144	7,5	151 329 2630 2	25 x 50	159	12,5	151 329 2631 2	25 x 65	172	20,0	151 329 2632 2	25 x 80	177	27,5	151 329 2683 2					40 x 50	163	5,0	151 329 2634 2	40 x 65	177	12,5	151 329 2635 2	40 x 80	181	20,0	151 329 2684 2	40 x 100	195	31,0	151 329 2637 2					50 x 65	180	7,5	151 329 2638 2	50 x 80	185	15,0	151 329 2685 2	50 x 100	197	26,0	151 329 2640 2					65 x 80	185	7,5	151 329 2686 2	65 x 100	197	18,5	151 329 2642 2	65 x 125	227	31,0	151 329 2643 2	80 x 100	207	11,0	151 329 2687 2	80 x 125	232	23,5	151 329 2688 2					100 x 125	234	12,5	151 329 2646 2	100 x 150	247	26,5	151 329 2647 2	125 x 150	250	14,0	151 329 2648 2		
DN	ca. Länge mm	Mittensversatz mm																																																																																																	
25 x 40	144	7,5	151 329 2630 2																																																																																																
25 x 50	159	12,5	151 329 2631 2																																																																																																
25 x 65	172	20,0	151 329 2632 2																																																																																																
25 x 80	177	27,5	151 329 2683 2																																																																																																
40 x 50	163	5,0	151 329 2634 2																																																																																																
40 x 65	177	12,5	151 329 2635 2																																																																																																
40 x 80	181	20,0	151 329 2684 2																																																																																																
40 x 100	195	31,0	151 329 2637 2																																																																																																
50 x 65	180	7,5	151 329 2638 2																																																																																																
50 x 80	185	15,0	151 329 2685 2																																																																																																
50 x 100	197	26,0	151 329 2640 2																																																																																																
65 x 80	185	7,5	151 329 2686 2																																																																																																
65 x 100	197	18,5	151 329 2642 2																																																																																																
65 x 125	227	31,0	151 329 2643 2																																																																																																
80 x 100	207	11,0	151 329 2687 2																																																																																																
80 x 125	232	23,5	151 329 2688 2																																																																																																
100 x 125	234	12,5	151 329 2646 2																																																																																																
100 x 150	247	26,5	151 329 2647 2																																																																																																
125 x 150	250	14,0	151 329 2648 2																																																																																																
2.807	Zwischenring mit 3/4"-Anschluss, aus Aluminium																																																																																																		
	<table border="0"> <thead> <tr> <th>DN</th> <th>Länge mm</th> <th></th> </tr> </thead> <tbody> <tr><td>25</td><td>40</td><td>151 336 2667 2</td></tr> <tr><td>40</td><td>40</td><td>151 327 2625 2</td></tr> <tr><td>50</td><td>40</td><td>151 327 2674 2</td></tr> <tr><td>65</td><td>40</td><td>151 327 2675 2</td></tr> <tr><td>80</td><td>40</td><td>151 327 2676 2</td></tr> <tr><td>100</td><td>40</td><td>151 327 2677 2</td></tr> <tr><td>125</td><td>40</td><td>151 327 2678 2</td></tr> <tr><td>150</td><td>40</td><td>270 805 2616 2</td></tr> </tbody> </table>	DN	Länge mm		25	40	151 336 2667 2	40	40	151 327 2625 2	50	40	151 327 2674 2	65	40	151 327 2675 2	80	40	151 327 2676 2	100	40	151 327 2677 2	125	40	151 327 2678 2	150	40	270 805 2616 2																																																																							
DN	Länge mm																																																																																																		
25	40	151 336 2667 2																																																																																																	
40	40	151 327 2625 2																																																																																																	
50	40	151 327 2674 2																																																																																																	
65	40	151 327 2675 2																																																																																																	
80	40	151 327 2676 2																																																																																																	
100	40	151 327 2677 2																																																																																																	
125	40	151 327 2678 2																																																																																																	
150	40	270 805 2616 2																																																																																																	
2.808	Flanschbogen 90°, aus Aluminium (max. Betriebsdruck 3 bar) Flanschanschluss: DIN 2633 PN16, nicht für Einbau vor dem Hochdruckregler																																																																																																		
	<table border="0"> <tbody> <tr><td>DN 25</td><td></td><td>151 330 2606 2</td></tr> <tr><td>DN 40</td><td></td><td>151 330 2607 2</td></tr> <tr><td>DN 50</td><td></td><td>151 329 2652 2</td></tr> <tr><td>DN 65</td><td></td><td>151 329 2653 2</td></tr> <tr><td colspan="3"> </td></tr> <tr><td>DN 80</td><td></td><td>151 329 2682 2</td></tr> <tr><td>DN 100</td><td></td><td>151 329 2655 2</td></tr> <tr><td>DN 125</td><td></td><td>151 329 2656 2</td></tr> <tr><td>DN 150</td><td></td><td>151 329 2657 2</td></tr> </tbody> </table>	DN 25		151 330 2606 2	DN 40		151 330 2607 2	DN 50		151 329 2652 2	DN 65		151 329 2653 2				DN 80		151 329 2682 2	DN 100		151 329 2655 2	DN 125		151 329 2656 2	DN 150		151 329 2657 2																																																																							
DN 25		151 330 2606 2																																																																																																	
DN 40		151 330 2607 2																																																																																																	
DN 50		151 329 2652 2																																																																																																	
DN 65		151 329 2653 2																																																																																																	
DN 80		151 329 2682 2																																																																																																	
DN 100		151 329 2655 2																																																																																																	
DN 125		151 329 2656 2																																																																																																	
DN 150		151 329 2657 2																																																																																																	
2.809	Übergangsflanschbogen Set																																																																																																		
	<table border="0"> <tbody> <tr><td>DN 65 – DN 40</td><td></td><td>151 332 2614 2</td></tr> <tr><td>DN 65 – DN 50</td><td></td><td>151 332 2615 2</td></tr> <tr><td>DN 80 – DN 50</td><td></td><td>151 332 2616 2</td></tr> <tr><td>DN 80 – DN 65</td><td></td><td>151 332 2617 2</td></tr> <tr><td>DN 100 – DN 50</td><td></td><td>151 332 2618 2</td></tr> <tr><td>DN 100 – DN 65</td><td></td><td>151 332 2619 2</td></tr> <tr><td>DN 100 – DN 80</td><td></td><td>151 332 2620 2</td></tr> <tr><td>DN 125 – DN 50</td><td></td><td>151 332 2621 2</td></tr> <tr><td>DN 125 – DN 65</td><td></td><td>151 332 2622 2</td></tr> <tr><td>DN 125 – DN 80</td><td></td><td>151 332 2623 2</td></tr> <tr><td>DN 125 – DN 100</td><td></td><td>151 332 2624 2</td></tr> <tr><td>DN 150 – DN 100</td><td></td><td>151 332 2625 2</td></tr> <tr><td>DN 150 – DN 125</td><td></td><td>151 332 2626 2</td></tr> </tbody> </table> Lieferumfang: Schrauben, Muttern, Dichtung beidseitig	DN 65 – DN 40		151 332 2614 2	DN 65 – DN 50		151 332 2615 2	DN 80 – DN 50		151 332 2616 2	DN 80 – DN 65		151 332 2617 2	DN 100 – DN 50		151 332 2618 2	DN 100 – DN 65		151 332 2619 2	DN 100 – DN 80		151 332 2620 2	DN 125 – DN 50		151 332 2621 2	DN 125 – DN 65		151 332 2622 2	DN 125 – DN 80		151 332 2623 2	DN 125 – DN 100		151 332 2624 2	DN 150 – DN 100		151 332 2625 2	DN 150 – DN 125		151 332 2626 2																																																											
DN 65 – DN 40		151 332 2614 2																																																																																																	
DN 65 – DN 50		151 332 2615 2																																																																																																	
DN 80 – DN 50		151 332 2616 2																																																																																																	
DN 80 – DN 65		151 332 2617 2																																																																																																	
DN 100 – DN 50		151 332 2618 2																																																																																																	
DN 100 – DN 65		151 332 2619 2																																																																																																	
DN 100 – DN 80		151 332 2620 2																																																																																																	
DN 125 – DN 50		151 332 2621 2																																																																																																	
DN 125 – DN 65		151 332 2622 2																																																																																																	
DN 125 – DN 80		151 332 2623 2																																																																																																	
DN 125 – DN 100		151 332 2624 2																																																																																																	
DN 150 – DN 100		151 332 2625 2																																																																																																	
DN 150 – DN 125		151 332 2626 2																																																																																																	
2.810	Austausch von Einzelventilen MVD...auf Doppelventil DMV. Für den Längenausgleich werden folgende Zwischenflansche benötigt:																																																																																																		
	<table border="0"> <tbody> <tr><td>Zwischenflansch</td><td>DN 65</td><td>290 mm lang</td><td>151 337 2610 2</td></tr> <tr><td>Zwischenflansch</td><td>DN 80</td><td>310 mm lang</td><td>151 337 2611 2</td></tr> <tr><td>Zwischenflansch</td><td>DN 100</td><td>350 mm lang</td><td>151 337 2612 2</td></tr> <tr><td>Zwischenflansch</td><td>DN 125</td><td>400 mm lang</td><td>151 337 2613 2</td></tr> <tr><td>Zwischenflansch</td><td>DN 150</td><td>480 mm lang</td><td>151 337 2614 2</td></tr> </tbody> </table>	Zwischenflansch	DN 65	290 mm lang	151 337 2610 2	Zwischenflansch	DN 80	310 mm lang	151 337 2611 2	Zwischenflansch	DN 100	350 mm lang	151 337 2612 2	Zwischenflansch	DN 125	400 mm lang	151 337 2613 2	Zwischenflansch	DN 150	480 mm lang	151 337 2614 2																																																																														
Zwischenflansch	DN 65	290 mm lang	151 337 2610 2																																																																																																
Zwischenflansch	DN 80	310 mm lang	151 337 2611 2																																																																																																
Zwischenflansch	DN 100	350 mm lang	151 337 2612 2																																																																																																
Zwischenflansch	DN 125	400 mm lang	151 337 2613 2																																																																																																
Zwischenflansch	DN 150	480 mm lang	151 337 2614 2																																																																																																

No.	Description																																																												
2.806	<p>Reducing flanges, excentric, of aluminium (max. operating pressure 3 bar) flanged: DIN 2633, PN16 not to be installed before the high pressure regulator</p> <table border="1"> <thead> <tr> <th>DN</th> <th>approx. length. mm</th> <th>Centre offset mm</th> </tr> </thead> <tbody> <tr><td>25 x 40</td><td>144</td><td>7,5</td></tr> <tr><td>25 x 50</td><td>159</td><td>12,5</td></tr> <tr><td>25 x 65</td><td>172</td><td>20,0</td></tr> <tr><td>25 x 80</td><td>177</td><td>27,5</td></tr> <tr><td>40 x 50</td><td>163</td><td>5,0</td></tr> <tr><td>40 x 65</td><td>177</td><td>12,5</td></tr> <tr><td>40 x 80</td><td>181</td><td>20,0</td></tr> <tr><td>40 x 100</td><td>195</td><td>31,0</td></tr> <tr><td>50 x 65</td><td>180</td><td>7,5</td></tr> <tr><td>50 x 80</td><td>185</td><td>15,0</td></tr> <tr><td>50 x 100</td><td>197</td><td>26,0</td></tr> <tr><td>65 x 80</td><td>185</td><td>7,5</td></tr> <tr><td>65 x 100</td><td>197</td><td>18,5</td></tr> <tr><td>65 x 125</td><td>227</td><td>31,0</td></tr> <tr><td>80 x 100</td><td>207</td><td>11,0</td></tr> <tr><td>80 x 125</td><td>232</td><td>23,5</td></tr> <tr><td>100 x 125</td><td>234</td><td>12,5</td></tr> <tr><td>100 x 150</td><td>247</td><td>26,5</td></tr> <tr><td>125 x 150</td><td>250</td><td>14,0</td></tr> </tbody> </table> <p>Included in delivery: Screws, nuts and sealing rings for 2 connection points</p>	DN	approx. length. mm	Centre offset mm	25 x 40	144	7,5	25 x 50	159	12,5	25 x 65	172	20,0	25 x 80	177	27,5	40 x 50	163	5,0	40 x 65	177	12,5	40 x 80	181	20,0	40 x 100	195	31,0	50 x 65	180	7,5	50 x 80	185	15,0	50 x 100	197	26,0	65 x 80	185	7,5	65 x 100	197	18,5	65 x 125	227	31,0	80 x 100	207	11,0	80 x 125	232	23,5	100 x 125	234	12,5	100 x 150	247	26,5	125 x 150	250	14,0
DN	approx. length. mm	Centre offset mm																																																											
25 x 40	144	7,5																																																											
25 x 50	159	12,5																																																											
25 x 65	172	20,0																																																											
25 x 80	177	27,5																																																											
40 x 50	163	5,0																																																											
40 x 65	177	12,5																																																											
40 x 80	181	20,0																																																											
40 x 100	195	31,0																																																											
50 x 65	180	7,5																																																											
50 x 80	185	15,0																																																											
50 x 100	197	26,0																																																											
65 x 80	185	7,5																																																											
65 x 100	197	18,5																																																											
65 x 125	227	31,0																																																											
80 x 100	207	11,0																																																											
80 x 125	232	23,5																																																											
100 x 125	234	12,5																																																											
100 x 150	247	26,5																																																											
125 x 150	250	14,0																																																											
2.807	<p>Intermediate rings with 3/4" connection</p> <table border="1"> <thead> <tr> <th>DN</th> <th>Length mm</th> </tr> </thead> <tbody> <tr><td>25</td><td>40</td></tr> <tr><td>40</td><td>40</td></tr> <tr><td>50</td><td>40</td></tr> <tr><td>65</td><td>40</td></tr> <tr><td>80</td><td>40</td></tr> <tr><td>100</td><td>40</td></tr> <tr><td>125</td><td>40</td></tr> <tr><td>150</td><td>40</td></tr> </tbody> </table>	DN	Length mm	25	40	40	40	50	40	65	40	80	40	100	40	125	40	150	40																																										
DN	Length mm																																																												
25	40																																																												
40	40																																																												
50	40																																																												
65	40																																																												
80	40																																																												
100	40																																																												
125	40																																																												
150	40																																																												
2.808	<p>Flange elbows, 90°, aluminium (max. operating pressure 3 bar) Flange connection: DIN 2633 PN16 not to be installed before the high pressure regulator</p> <p>DN 25 DN 40 DN 50 DN 65 DN 80 DN 100 DN 125 DN 150</p>																																																												
2.809	<p>Intermediate flange elbow set</p> <p>DN 65 – DN 40 DN 65 – DN 50 DN 80 – DN 50 DN 80 – DN 65 DN 100 – DN 50 DN 100 – DN 65 DN 100 – DN 80 DN 125 – DN 50 DN 125 – DN 65 DN 125 – DN 80 DN 125 – DN 100 DN 150 – DN 100 DN 150 – DN 125</p> <p>Included in delivery: Screws, nuts, gasket both sides</p>																																																												
2.810	<p>Replacement of single valves MVD... with double valves DMV. The following intermediate flanges are required for length compensation:</p> <table border="1"> <tbody> <tr><td>Intermediate flange</td><td>DN 65</td><td>290 mm long</td></tr> <tr><td>Intermediate flange</td><td>DN 80</td><td>310 mm long</td></tr> <tr><td>Intermediate flange</td><td>DN 100</td><td>350 mm long</td></tr> <tr><td>Intermediate flange</td><td>DN 125</td><td>400 mm long</td></tr> <tr><td>Intermediate flange</td><td>DN 150</td><td>480 mm long</td></tr> </tbody> </table>	Intermediate flange	DN 65	290 mm long	Intermediate flange	DN 80	310 mm long	Intermediate flange	DN 100	350 mm long	Intermediate flange	DN 125	400 mm long	Intermediate flange	DN 150	480 mm long																																													
Intermediate flange	DN 65	290 mm long																																																											
Intermediate flange	DN 80	310 mm long																																																											
Intermediate flange	DN 100	350 mm long																																																											
Intermediate flange	DN 125	400 mm long																																																											
Intermediate flange	DN 150	480 mm long																																																											

No.	Dénomination																																																												
2.806	<p>Bride de réduction excentrique, en aluminium (pression de service max. 3 bar) à brides : DIN 2633, PN16, Non prévu pour le montage avant le régulateur HP</p> <table border="1"> <thead> <tr> <th>DN</th> <th>Longueur env. mm</th> <th>décalage axe mm</th> </tr> </thead> <tbody> <tr><td>25 x 40</td><td>144</td><td>7,5</td></tr> <tr><td>25 x 50</td><td>159</td><td>12,5</td></tr> <tr><td>25 x 65</td><td>172</td><td>20,0</td></tr> <tr><td>25 x 80</td><td>177</td><td>27,5</td></tr> <tr><td>40 x 50</td><td>163</td><td>5,0</td></tr> <tr><td>40 x 65</td><td>177</td><td>12,5</td></tr> <tr><td>40 x 80</td><td>181</td><td>20,0</td></tr> <tr><td>40 x 100</td><td>195</td><td>31,0</td></tr> <tr><td>50 x 65</td><td>180</td><td>7,5</td></tr> <tr><td>50 x 80</td><td>185</td><td>15,0</td></tr> <tr><td>50 x 100</td><td>197</td><td>26,0</td></tr> <tr><td>65 x 80</td><td>185</td><td>7,5</td></tr> <tr><td>65 x 100</td><td>197</td><td>18,5</td></tr> <tr><td>65 x 125</td><td>227</td><td>31,0</td></tr> <tr><td>80 x 100</td><td>207</td><td>11,0</td></tr> <tr><td>80 x 125</td><td>232</td><td>23,5</td></tr> <tr><td>100 x 125</td><td>234</td><td>12,5</td></tr> <tr><td>100 x 150</td><td>247</td><td>26,5</td></tr> <tr><td>125 x 150</td><td>250</td><td>14,0</td></tr> </tbody> </table> <p>La fourniture comprend : vis, écrous et joints pour 2 liaisons</p>	DN	Longueur env. mm	décalage axe mm	25 x 40	144	7,5	25 x 50	159	12,5	25 x 65	172	20,0	25 x 80	177	27,5	40 x 50	163	5,0	40 x 65	177	12,5	40 x 80	181	20,0	40 x 100	195	31,0	50 x 65	180	7,5	50 x 80	185	15,0	50 x 100	197	26,0	65 x 80	185	7,5	65 x 100	197	18,5	65 x 125	227	31,0	80 x 100	207	11,0	80 x 125	232	23,5	100 x 125	234	12,5	100 x 150	247	26,5	125 x 150	250	14,0
DN	Longueur env. mm	décalage axe mm																																																											
25 x 40	144	7,5																																																											
25 x 50	159	12,5																																																											
25 x 65	172	20,0																																																											
25 x 80	177	27,5																																																											
40 x 50	163	5,0																																																											
40 x 65	177	12,5																																																											
40 x 80	181	20,0																																																											
40 x 100	195	31,0																																																											
50 x 65	180	7,5																																																											
50 x 80	185	15,0																																																											
50 x 100	197	26,0																																																											
65 x 80	185	7,5																																																											
65 x 100	197	18,5																																																											
65 x 125	227	31,0																																																											
80 x 100	207	11,0																																																											
80 x 125	232	23,5																																																											
100 x 125	234	12,5																																																											
100 x 150	247	26,5																																																											
125 x 150	250	14,0																																																											
2.807	<p>Bague intermédiaire avec raccord 3/4", en aluminium</p> <table border="1"> <thead> <tr> <th>DN</th> <th>Longueur mm</th> </tr> </thead> <tbody> <tr><td>25</td><td>40</td></tr> <tr><td>40</td><td>40</td></tr> <tr><td>50</td><td>40</td></tr> <tr><td>65</td><td>40</td></tr> <tr><td>80</td><td>40</td></tr> <tr><td>100</td><td>40</td></tr> <tr><td>125</td><td>40</td></tr> <tr><td>150</td><td>40</td></tr> </tbody> </table>	DN	Longueur mm	25	40	40	40	50	40	65	40	80	40	100	40	125	40	150	40																																										
DN	Longueur mm																																																												
25	40																																																												
40	40																																																												
50	40																																																												
65	40																																																												
80	40																																																												
100	40																																																												
125	40																																																												
150	40																																																												
2.808	<p>Coude à brides 90°, en aluminium (pression de service max. 3 bar) Raccordement à brides : DIN 2633 PN16, pas pour le montage avant le régulateur HP</p> <p>DN 25 DN 40 DN 50 DN 65 DN 80 DN 100 DN 125 DN 150</p>																																																												
2.809	<p>Ensemble coude concentrique</p> <p>DN 65 – DN 40 DN 65 – DN 50 DN 80 – DN 50 DN 80 – DN 65 DN 100 – DN 50 DN 100 – DN 65 DN 100 – DN 80 DN 125 – DN 50 DN 125 – DN 65 DN 125 – DN 80 DN 125 – DN 100 DN 150 – DN 100 DN 150 – DN 125</p> <p>La fourniture comprend : vis, écrous et joints des deux côtés</p>																																																												
2.810	<p>Remplacement vanne magn. simples MVD...par double vanne DMV. Bride intermédiaire nécessaire pour l'adaptation :</p> <table border="1"> <tbody> <tr><td>Bride intermédiaire</td><td>DN 65</td><td>long. 290 mm</td></tr> <tr><td>Bride intermédiaire</td><td>DN 80</td><td>long. 310 mm</td></tr> <tr><td>Bride intermédiaire</td><td>DN 100</td><td>long. 350 mm</td></tr> <tr><td>Bride intermédiaire</td><td>DN 125</td><td>long. 400 mm</td></tr> <tr><td>Bride intermédiaire</td><td>DN 150</td><td>long. 480 mm</td></tr> </tbody> </table>	Bride intermédiaire	DN 65	long. 290 mm	Bride intermédiaire	DN 80	long. 310 mm	Bride intermédiaire	DN 100	long. 350 mm	Bride intermédiaire	DN 125	long. 400 mm	Bride intermédiaire	DN 150	long. 480 mm																																													
Bride intermédiaire	DN 65	long. 290 mm																																																											
Bride intermédiaire	DN 80	long. 310 mm																																																											
Bride intermédiaire	DN 100	long. 350 mm																																																											
Bride intermédiaire	DN 125	long. 400 mm																																																											
Bride intermédiaire	DN 150	long. 480 mm																																																											



2.811

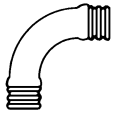

2.812



2.813



2.814

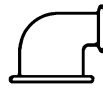

2.815

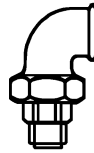

2.816



2.817



2.818



2.819

Nr.	Bezeichnung	Bestell-Nr. Order No. N° de commande	Preis EUR (o. MwSt.)
2.811	Bogen lang, 90°, mit Innen- und Außengewinde 1/2 3/4 1 1 1/4 1 1/2 2	453 230 453 231 453 218 453 233 453 219 453 220	
2.812	Bogen lang, 90°, mit Außengewinde 1/2 3/4 1 1 1/4 1 1/2 2	453 228 453 229 453 223 453 234 453 224 453 225	
2.813	Muffe 3/8 1/2 3/4 1 1 1/4 1 1/2 2	151 336 2630 7 453 500 453 524 453 514 453 517 453 515 453 516	
2.814	Winkel 90° mit Innengewinde 3/8 1/4 1/2 3/4 1 1 1/4 1 1/2 2 1 1/2 Innen/Außengewinde	453 103 453 144 453 104 453 143 453 123 453 107 453 137 453 112 453 155	
2.815	Reduzier-Winkel 90° mit Innengewinde 3/4 x 1/2 1 x 1/2 1 x 3/4 1 x 1 1/4 1 x 1 1/2 1 1/4 x 3/4 1 1/4 x 1 1 1/2 x 3/4 2 x 1 2 x 1 1/4 2 x 1 1/2	453 102 453 108 453 125 453 127 453 124 453 129 453 130 453 138 453 115 453 131 453 116	
2.816	Winkel-Verschraubung, Dichtungen siehe Pos. 2.822 3/8 1/2 3/4 1 1 1/2 2	453 419 453 421 453 422 453 423 453 424 453 425	
2.817	Verschraubung mit Außen- u. Innengewinde, Dichtungen siehe Pos. 2.823 3/8 1/2 3/4 1 2	453 402 453 411 453 401 453 400 453 412	
2.818	Verschraubung mit Außengewinde, Dichtungen siehe Pos. 2.822 1/2 GF336 3/4 GF336 1 GF336 1 1/4 GF336 1 1/2 GF336	453 407 453 404 453 405 453 408 453 406	
2.819	Reduktionsnippel, mit Außen- und Innengewinde 3/4 x 1/2 1 x 1/2 1 x 3/4 1 1/2 x 3/4 1 1/2 x 1 2 x 3/4 2 x 1 2 x 1 1/2	453 084 453 735 453 086 453 085 453 713 453 710 453 719 453 718	

No.	Description	No.	Dénomination
2.811	Elbows long, 90°, with internal and external thread 1/2 3/4 1 1 1/4 1 1/2 2	2.811	Coude long, 90°, avec filetage intérieur et extérieur 1/2 3/4 1 1 1/4 1 1/2 2
2.812	Elbows long, 90°, with external thread 1/2 3/4 1 1 1/4 1 1/2 2	2.812	Coude long, 90°, avec filetage extérieur 1/2 3/4 1 1 1/4 1 1/2 2
2.813	Socket 3/8 1/2 3/4 1 1 1/4 1 1/2 2	2.813	Manchon 3/8 1/2 3/4 1 1 1/4 1 1/2 2
2.814	Angles 90° with internal thread 3/8 1/4 1/2 3/4 1 1 1/4 1 1/2 2 1 1/2 internal/external thread	2.814	Coude équerre 90° avec filetage intérieur 3/8 1/4 1/2 3/4 1 1 1/4 1 1/2 2 1 1/2 filetage intérieur/extérieur
2.815	Reducing elbow 90° with internal thread 3/4 x 1/2 1 x 1/2 1 x 3/4 1 x 1 1/4 1 x 1 1/2 1 1/4 x 3/4 1 1/4 x 1 1 1/2 x 3/4 2 x 1 2 x 1 1/4 2 x 1 1/2	2.815	Réducteur équerre 90° avec filetage intérieur 3/4 x 1/2 1 x 1/2 1 x 3/4 1 x 1 1/4 1 x 1 1/2 1 1/4 x 3/4 1 1/4 x 1 1 1/2 x 3/4 2 x 1 2 x 1 1/4 2 x 1 1/2
2.816	Union elbow, seals see pos. 2.822 3/8 1/2 3/4 1 1 1/2 2	2.816	Raccord équerre, joints voir pos. 2.822 3/8 1/2 3/4 1 1 1/2 2
2.817	Screwed union with internal and external thread, seals see pos. 2.823 3/8 1/2 3/4 1 2	2.817	Raccord avec filetages extérieur et intérieur, joints voir pos. 2.823 3/8 1/2 3/4 1 2
2.818	Screwed union with external thread, seals see pos. 2.822 1/2 GF336 3/4 GF336 1 GF336 1 1/4 GF336 1 1/2 GF336	2.818	Raccord avec filetage extérieur, joints voir pos. 2.822 1/2 GF336 3/4 GF336 1 GF336 1 1/4 GF336 1 1/2 GF336
2.819	Reducing nipple, with external and internal thread 3/4 x 1/2 1 x 1/2 1 x 3/4 1 1/2 x 3/4 1 1/2 x 1 2 x 3/4 2 x 1 2 x 1 1/2	2.819	Manchon de réduction, avec filetages extérieur et intérieur 3/4 x 1/2 1 x 1/2 1 x 3/4 1 1/2 x 3/4 1 1/2 x 1 2 x 3/4 2 x 1 2 x 1 1/2

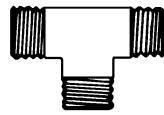

2.819.1

2.820

2.820.1

Nr.	Bezeichnung	Bestell-Nr. Order No. N° de commande	Preis EUR (o. MwSt.)
2.819.1	Muffe M4 IG x AG		
	3/4 x 1/2	453 724	
	1 x 3/4	453 741	
	1 1/2 x 1	453 746	
	2 x 1	453 747	
	2 x 1 1/2	453 745	
2.820	Doppelnippel		
	R 1/4 x 50 mm	139 000 2601 7	
	R 1/4 x 160 mm	139 000 2634 7	
	R 3/8 x 50 mm	139 000 2602 7	
	R 3/8 x 160 mm	139 000 2643 7	
	R 3/8 x 200 mm	139 000 2604 7	
	R 3/8 x 250 mm	139 000 2633 7	
2.820	Doppelnippel		
	R 1/2 x 40 mm	139 000 2654 7	
	R 1/2 x 50 mm	139 000 2605 7	
	R 1/2 x 70 mm	139 000 2606 7	
	R 1/2 x 75 mm	139 000 2652 7	
	R 1/2 x 80 mm	139 000 2607 7	
	R 1/2 x 100 mm	139 000 2655 7	
	R 1/2 x 175 mm	139 000 2653 7	
	R 1/2 x 180 mm	139 000 2608 7	
	R 1/2 x 200 mm	139 000 2609 7	
	R 1/2 x 250 mm	139 000 2629 7	
	R 1/2 x 300 mm	139 000 2630 7	
	R 1/2 x 320 mm	139 000 2610 7	
	R 3/4 x 50 mm	139 000 2611 7	
	R 3/4 x 60 mm	139 000 2691 7	
	R 3/4 x 70 mm	139 000 2692 7	
	R 3/4 x 80 mm	139 000 2612 7	
	R 3/4 x 90 mm	139 000 2693 7	
	R 3/4 x 110 mm	139 000 2694 7	
	R 3/4 x 130 mm	139 000 2695 7	
	R 3/4 x 140 mm	139 000 2696 7	
	R 3/4 x 160 mm	139 000 2613 7	
	R 3/4 x 180 mm	139 000 2614 7	
	R 3/4 x 190 mm	139 000 2697 7	
	R 3/4 x 200 mm	139 000 2615 7	
	R 3/4 x 225 mm	139 000 2616 7	
	R 3/4 x 250 mm	139 000 2647 7	
	R 3/4 x 300 mm	139 000 2631 7	
	R 1 x 50 mm	139 000 2617 7	
	R 1 x 80 mm	139 000 2639 7	
	R 1 x 100 mm	139 000 2618 7	
	R 1 x 120 mm	139 000 2619 7	
	R 1 x 160 mm	139 000 2620 7	
	R 1 x 180 mm	139 000 2640 7	
	R 1 x 200 mm	139 000 2621 7	
	R 1 x 250 mm	139 000 2648 7	
	R 1 x 300 mm	139 000 2632 7	
	R 1 x 335 mm	139 000 2657 7	
	R 1 1/4 x 80 mm	139 000 2635 7	
	R 1 1/4 x 120 mm	139 000 2636 7	
	R 1 1/4 x 180 mm	139 000 2637 7	
	R 1 1/4 x 250 mm	139 000 2649 7	
	R 1 1/2 x 50 mm	139 000 2622 7	
	R 1 1/2 x 120 mm	139 000 2623 7	
	R 1 1/2 x 160 mm	139 000 2624 7	
	R 1 1/2 x 200 mm	139 000 2625 7	
	R 1 1/2 x 250 mm	139 000 2651 7	
	R 2 x 80 mm	139 000 2626 7	
	R 2 x 120 mm	139 000 2669 7	
	R 2 x 160 mm	139 000 2627 7	
	R 2 x 200 mm	139 000 2628 7	
2.820.1	T-Stück für Manometer- und Zündgasanschluss		
	1/2 x 74 mm Außengewinde	453 612	
	3/4 x 86 mm Außengewinde	453 613	
	1 x 96 mm Außengewinde	453 614	
	1 1/2 x 112 mm Innengewinde (ohne Bild)	453 609	
	2 x 130 mm Innengewinde (ohne Bild)	453 610	

No.	Description
2.819.1	Socket M4 IG x AG 3/4 x 1/2 1 x 3/4 1 1/2 x 1 2 x 1 2 x 1 1/2
2.820	Double nipple R 1/4 x 50 mm R 1/4 x 160 mm R 3/8 x 50 mm R 3/8 x 160 mm R 3/8 x 200 mm R 3/8 x 250 mm
2.820	Double nipple R 1/2 x 40 mm R 1/2 x 50 mm R 1/2 x 70 mm R 1/2 x 75 mm R 1/2 x 80 mm R 1/2 x 100 mm R 1/2 x 175 mm R 1/2 x 180 mm R 1/2 x 200 mm R 1/2 x 250 mm R 1/2 x 300 mm R 1/2 x 320 mm R 3/4 x 50 mm R 3/4 x 60 mm R 3/4 x 70 mm R 3/4 x 80 mm R 3/4 x 90 mm R 3/4 x 110 mm R 3/4 x 130 mm R 3/4 x 140 mm R 3/4 x 160 mm R 3/4 x 180 mm R 3/4 x 190 mm R 3/4 x 200 mm R 3/4 x 225 mm R 3/4 x 250 mm R 3/4 x 300 mm R 1 x 50 mm R 1 x 80 mm R 1 x 100 mm R 1 x 120 mm R 1 x 160 mm R 1 x 180 mm R 1 x 200 mm R 1 x 250 mm R 1 x 300 mm R 1 x 335 mm R 1 1/4 x 80 mm R 1 1/4 x 120 mm R 1 1/4 x 180 mm R 1 1/4 x 250 mm R 1 1/2 x 50 mm R 1 1/2 x 120 mm R 1 1/2 x 160 mm R 1 1/2 x 200 mm R 1 1/2 x 250 mm R 2 x 80 mm R 2 x 120 mm R 2 x 160 mm R 2 x 200 mm
2.820.1	T piece for pressure gauge and ignition gas connection 1/2 x 74 mm external thread 3/4 x 86 mm external thread 1 x 96 mm external thread 1 1/2 x 112 mm internal thread (without picture) 2 x 130 mm internal thread (without picture)

No.	Dénomination
2.819.1	Manchon M4 IG x AG 3/4 x 1/2 1 x 3/4 1 1/2 x 1 2 x 1 2 x 1 1/2
2.820	Mamelon double R 1/4 x 50 mm R 1/4 x 160 mm R 3/8 x 50 mm R 3/8 x 160 mm R 3/8 x 200 mm R 3/8 x 250 mm
2.820	Mamelon double R 1/2 x 40 mm R 1/2 x 50 mm R 1/2 x 70 mm R 1/2 x 75 mm R 1/2 x 80 mm R 1/2 x 100 mm R 1/2 x 175 mm R 1/2 x 180 mm R 1/2 x 200 mm R 1/2 x 250 mm R 1/2 x 300 mm R 1/2 x 320 mm R 3/4 x 50 mm R 3/4 x 60 mm R 3/4 x 70 mm R 3/4 x 80 mm R 3/4 x 90 mm R 3/4 x 110 mm R 3/4 x 130 mm R 3/4 x 140 mm R 3/4 x 160 mm R 3/4 x 180 mm R 3/4 x 190 mm R 3/4 x 200 mm R 3/4 x 225 mm R 3/4 x 250 mm R 3/4 x 300 mm R 1 x 50 mm R 1 x 80 mm R 1 x 100 mm R 1 x 120 mm R 1 x 160 mm R 1 x 180 mm R 1 x 200 mm R 1 x 250 mm R 1 x 300 mm R 1 x 335 mm R 1 1/4 x 80 mm R 1 1/4 x 120 mm R 1 1/4 x 180 mm R 1 1/4 x 250 mm R 1 1/2 x 50 mm R 1 1/2 x 120 mm R 1 1/2 x 160 mm R 1 1/2 x 200 mm R 1 1/2 x 250 mm R 2 x 80 mm R 2 x 120 mm R 2 x 160 mm R 2 x 200 mm
2.820.1	Raccord en T pour raccordement manomètre et vanne d'allumage gaz 1/2 x 74 mm filetage extérieur 3/4 x 86 mm filetage extérieur 1 x 96 mm filetage extérieur 1 1/2 x 112 mm filetage intérieur (sans photo) 2 x 130 mm filetage intérieur (sans photo)

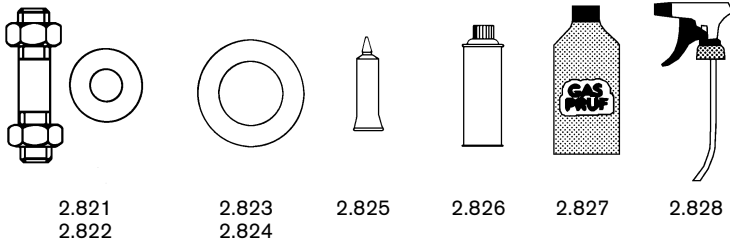

Nr.	Bezeichnung	Bestell-Nr. Order No. N° de commande	Preis EUR (o. MwSt.)
2.821	Verbindungssteile für eine Flanschverbindung, bestehend aus: Dichtung, Stiftschrauben, Sechskant-Muttern		
	DN 20	151 331 2633 2	
	DN 25	151 331 2629 2	
	DN 40	151 331 2630 2	
	DN 50	151 331 2631 2	
	DN 65	151 341 2604 2	
	DN 80	151 351 2607 2	
	DN 100	151 361 2604 2	
	DN 125	151 371 2603 2	
	DN 150	151 381 2602 2	
2.822	Verbindungssteile , für eine Flanschverbindung mit Alu-Zwischenring, bestehend aus: Dichtring, Stiftschrauben, Sechskant-Muttern		
	DN 25	151 336 2699 2	
	DN 40	151 331 2635 2	
	DN 50	151 331 2632 2	
	DN 65	151 341 2605 2	
	DN 80	151 351 2608 2	
	DN 100	151 361 2605 2	
	DN 125	151 371 2604 2	
2.823	Dichtungen aus reinem Gummikork Typ N 4090, bis 4 bar und 100 °C, für Verschraubungen (Gas)		
	17 x 24 mm ø für Verschraubung R 3/8	441 008	
	21 x 30 mm ø für Verschraubung R 1/2	441 009	
	27 x 38 mm ø für Verschraubung R 3/4	441 010	
	32 x 44 mm ø für Verschraubung R 1	441 011	
	42 x 56 mm ø für Verschraubung R 1 1/4	441 032	
	46 x 62 mm ø für Verschraubung R 1 1/2	441 012	
	60 x 78 mm ø für Verschraubung R 2	441 024	
2.824	Dichtungen aus Universal N, blau, bis 100 bar und 150 °C bei Gas, 40 bar und 180 °C bei Öl für Vorschweiß- und Gewindeflansche (Öl und Gas)		
	28 x 53 mm - DN 20	441 013	
	35 x 70 mm - DN 25	441 858	
	49 x 70 mm - DN 25/40 *	441 851	
	49 x 92 mm - DN 40	441 859	
	61 x 107 mm - DN 50	441 860	
	77 x 127 mm - DN 65	441 861	
	90 x 142 mm - DN 80	441 044	
	115 x 162 mm - DN 100	441 045	
	141 x 194 mm - DN 125	441 046	
	169 x 218 mm - DN 150	441 047	
	* Einsatz bei WM-G10/1 Ausführung ZMI Armatur R 1 1/2		
2.825	Dichtband PARALIQ PM 35, nicht aushärtendes Dichtungsmaterial für Rohrgewinde an Gasarmaturen für Gewinde DIN 2999 T1, Betriebstemp. max. 70°C, Betriebsdruck max. 5 bar	499 134	
2.826	Sprühreiniger zum reinigen und entfetten der Dichtstellen, Sprühdosen á 400 cm ³ , (FCKW-frei)	499 240	
2.827	Lecksuchmittel "Gasprüf-Flüssig", 500 g	499 208	
2.828	Sprayer für "Gasprüf-Flüssig"	499 209	
2.829	Mittelfeste Schraubensicherung SSM "Loctite", Flasche 50 ml	391 104	

No.	Description	No.	Dénomination
2.821	<p>Connection parts for one flange connection, consisting of: Sealing, studs, hexagon nuts DN 20 DN 25 DN 40</p> <p>DN 50 DN 65 DN 80</p> <p>DN 100 DN 125 DN 150</p>	2.821	<p>Éléments de liaison pour un raccord à brides, comprenant : joints, goujons avec écrous DN 20 DN 25 DN 40</p> <p>DN 50 DN 65 DN 80</p> <p>DN 100 DN 125 DN 150</p>
2.822	<p>Connection parts for one flange connection with intermediate ring, consisting of: Sealing ring, studs, hexagon nuts DN 25 DN 40 DN 50 DN 65</p> <p>DN 80 DN 100 DN 125</p>	2.822	<p>Éléments de liaison, pour un raccord à brides avec bague intermédiaire aluminium, comprenant : joint, goujons avec écrous DN 25 DN 40 DN 50 DN 65</p> <p>DN 80 DN 100 DN 125</p>
2.823	<p>Seals for screwed unions (gas) 17 x 24 mm ø for screwed union R 3/8 21 x 30 mm ø for screwed union R 1/2 27 x 38 mm ø for screwed union R 3/4 32 x 44 mm ø for screwed union R 1</p> <p>42 x 56 mm ø for screwed union R 1 1/4 46 x 62 mm ø for screwed union R 1 1/2 60 x 78 mm ø for screwed union R 2</p>	2.823	<p>Joints en liège type N 4090, jusqu'à 4 bar et 100 °C, pour raccords (gaz) 17 x 24 mm ø pour raccord R 3/8 21 x 30 mm ø pour raccord R 1/2 27 x 38 mm ø pour raccord R 3/4 32 x 44 mm ø pour raccord R 1</p> <p>42 x 56 mm ø pour raccord R 1 1/4 46 x 62 mm ø pour raccord R 1 1/2 60 x 78 mm ø pour raccord R 2</p>
2.824	<p>Gaskets made of Universal N, blue, up to 100 bar and 150 °C for gas, 40 bar and 180 °C for oil for welded and screwed flange (oil and gas) 28 x 53 mm - DN 20 35 x 70 mm - DN 25 49 x 70 mm - DN 25/40 * 49 x 92 mm - DN 40 61 x 107 mm - DN 50</p> <p>77 x 127 mm - DN 65 90 x 142 mm - DN 80 115 x 162 mm - DN 100</p> <p>141 x 194 mm - DN 125 169 x 218 mm - DN 150</p> <p>* Used for WM-G10/1 version ZMI valve train R 1 1/2</p>	2.824	<p>Joints universels N, bleu, jusqu'à 100 bar et 150 °C en gaz, 40 bar et 180 °C en fioul pour brides à souder et taraudées (fioul et gaz) 28 x 53 mm - DN 20 35 x 70 mm - DN 25 49 x 70 mm - DN 25/40 * 49 x 92 mm - DN 40 61 x 107 mm - DN 50</p> <p>77 x 127 mm - DN 65 90 x 142 mm - DN 80 115 x 162 mm - DN 100</p> <p>141 x 194 mm - DN 125 169 x 218 mm - DN 150</p> <p>* Utilisation avec WM-G10/1 exéc. ZMI rampe R 1 1/2</p>
2.825	<p>Seal PARALIQ PM 35, non hardening sealing material for pipe threads on valve trains, for thread DIN 2999 T1, operating stemp. max. 70 °C, operating pressure max. 5 bar</p>	2.825	<p>Colle PARALIQ PM35 produit d'attachéité assurant la tenue des rampes pour filetage DIN 2999 T1 Température de service max. 70 °C, pression de service max. 5 bar</p>
2.826	<p>Spray cleaner to clean and de-grease sealing joints, spray can 400 cm³ (CFC free)</p>	2.826	<p>Spray pour nettoyage et dégraissage des joints, Spray à 400 cm³, (sans FCKW)</p>
2.827	<p>Leak detecting spray "Gasprüf-Flüssig"</p>	2.827	<p>Spray "Gasprüf-Flüssig", 500 g</p>
2.828	<p>Spray bottle for "Gas leak detection fluid"</p>	2.828	<p>Vaporisateur pour "Gasprüf-Flüssig"</p>
2.829	<p>Semi solid tamper-proof resin SSM "Loctite", 50 ml bottle</p>	2.829	<p>Frein filet moyen SSM "Loctite", flacon 50 ml</p>

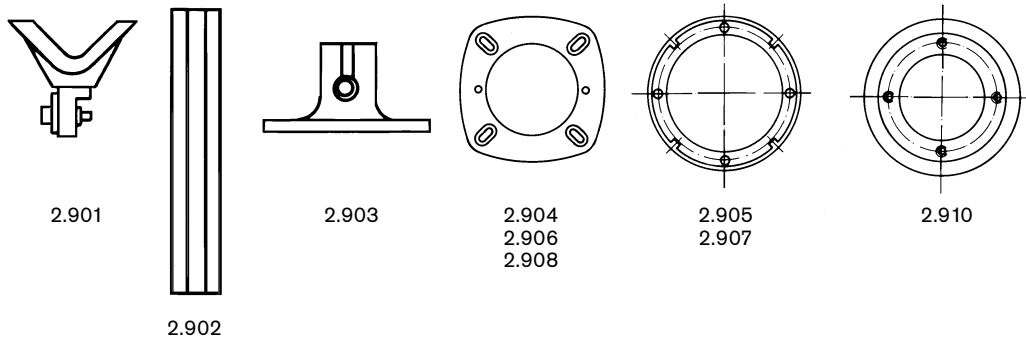

Nr.	Bezeichnung	Bestell-Nr. Order No. N° de commande	Preis EUR (o. MwSt.)
2.9	Armaturen-Abstützung, Distanzringe, Zwischenflansche		
	Gasarmaturen-Abstützung		
2.901	Prisma mit Klemmschraube	109 000 0045 2	
2.902	Montageschiene 950 mm lang	109 000 0033 7	
2.903	Haltefuß mit Klemmschraube	109 000 0044 2	
	Zwischenflansch , für Wärmeerzeuger mit vertieft liegender Kesselplatte oder Reinigungstür bzw. vorstehender Wendekammer, 35 mm dick, Brennergrößen		
2.904	G1, GL1 G3, GL3, RGL3	251 103 0002 2 251 303 0002 2	
2.905	L5Z-1LN, WM-L10/3, WM-L10/4 WM-L20/1-A bis /3-A G5, GL5, RGL5, WM-G(L)10/3, WM-G(L)10/4 G7, GL7, RGL7, WM-G(L)20 WM-G(L)10/2	110 564 0001 2 211 204 0002 2 151 518 0006 2 151 707 0005 2 217 104 0002 2	
	Zwischenflansch , für Wärmeerzeuger mit vertieft liegender Kesselplatte oder Reinigungstür bzw. vorstehender Wendekammer, 72 mm dick, Brennergrößen		
2.906	G1, GL1 G3, GL3, RGL3	251 103 0001 2 251 303 0001 2	
2.907	WM-G(L)10/2 G5, GL5, RGL5, WM-G(L)10/3, WM-G10/4 G7+G8, GL7+GL8, RGL7+RGL8, WM-G(L)20 G9+G10, GL9, RGL9+RGL10	217 104 0003 2 151 518 0005 2 151 707 0004 2 151 907 0004 2	
	Zum Lieferumfang gehören: Distanzring, Stiftschrauben, Unterlagscheiben und Muttern. Bei der Bestellung ist zu berücksichtigen, dass unter Umständen eine Flammrohrverlängerung notwendig wird.		
2.908	Zwischenflansch für mit Flanschdichtung und Schrauben 30 mm dick		
	WL5/WG5 W10-D / W20-C WL20-C für Leitung < 70 kw, (18 mm dick) WL30-C WL40 (40 mm dick)	240 050 0001 2 240 110 0101 2 240 210 0002 2 240 310 0001 2 240 400 0001 2	
	WGL30 WGL30, 80 mm WG30-C WG40 (40 mm dick)	230 300 0002 2 230 300 0003 2 240 310 0001 2 240 400 0001 2	
2.910	Brennerplatte 250 x 10 WL10, WL10-B, WG10 WL20, WL30, L1, WG20	109 000 0473 7 109 000 0474 7	
2.911	Glasnadelmatte ASGLASIL 15 x 500 x 1000	162 039	

No.	Description	No.	Dénomination
2.9	Gas valve train support, spacer rings, Intermediate flange	2.9	Support de rampe, entretoises, brides d'aspiration
	Gas valve train support		Support de rampe gaz
2.901	Prism with clamping screw	2.901	Prisme avec visserie
2.902	Mounting rail 950mm long	2.902	Rail de montage longueur 950 mm
2.903	Holding support with clamping screw	2.903	Support inférieur avec visserie
2.904	Intermediate flange, for heat exchanger with recessed boiler plate or cleaning door, or resp. protruding reversing chamber, 35 mm thick. Burner sizes G1, GL1 G3, GL3, RGL3	2.904	Entretoise, pour générateurs avec plaque foyer décalée par rapport à la jaquette ou porte de ramonage resp. boîte à fumées, épaisseur 35 mm , Grandeur du brûleur G1, GL1 G3, GL3, RGL3
2.905	L5Z-1LN, WM-L10/3, WM-L10/4 WM-L20/1-A bis /3-A G5, GL5, RGL5, WM-G(L)10/3, WM-G(L)10/4 G7, GL7, RGL7, WM-G(L)20 WM-G(L)10/2	2.905	L5Z-1LN, WM-L10/3, WM-L10/4 WM-L20/1-A bis /3-A G5, GL5, RGL5, WM-G(L)10/3, WM-G(L)10/4 G7, GL7, RGL7, WM-G(L)20 WM-G(L)10/2
2.906	Intermediate flange, for heat exchanger with recessed boiler plate or cleaning door, or resp. protruding reversing chamber, 72mm thick. Burner sizes G1, GL1 G3, GL3, RGL3	2.906	Entretoise, pour générateurs avec plaque foyer décalée par rapport à la jaquette ou porte de ramonage resp. boîte à fumées, épaisseur 72 mm, Grandeur du brûleur G1, GL1 G3, GL3, RGL3
2.907	WM-G(L)10/2 G5, GL5, RGL5, WM-G(L)10/3, WM-G10/4 G7+G8, GL7+GL8, RGL7+RGL8, WM-G(L)20 G9+G10, GL9, RGL9+RGL10 Spacer ring, studs, supporting discs and nuts are included in delivery. When ordering please note that under certain circumstances a flame tube extension is necessary.	2.907	WM-G(L)10/2 G5, GL5, RGL5, WM-G(L)10/3, WM-G10/4 G7+G8, GL7+GL8, RGL7+RGL8, WM-G(L)20 G9+G10, GL9, RGL9+RGL10 La fourniture comprend : entretoise, goujons, rondelles et écrous. Lors de la commande il faut prendre en compte qu'une rallonge de tête peut s'avérer nécessaire.
2.908	Intermediate flange 30 mm thick for with flange gasket and screws WL5/WG5 W10-D / W20-C WL20-C for line < 70 kw, (18 mm thick) WL30-C WL40 (40 mm thick) WGL30 WGL30, 80 mm WG30-C WG40 (40 mm thick)	2.908	Entretoise pour avec joint de bride et vis épaisseur 30 mm WL5/WG5 W10-D / W20-C WL20-C pour conduite < 70 kW, (épaisseur 18 mm) WL30-C WL40 (00040 mm) WGL30 WGL30, 80 mm WG30-C WG40 (épaisseur 40 mm)
2.910	Burner plate 250 x 10 WL10, WL10-B, WG10 WL20, WL30, L1, WG20	2.910	Plaque brûleur 250 x 10 WL10, WL10-B, WG10 WL20, WL30, L1, WG20
2.911	Glass fibre mat 15 x 500 x 1000	2.911	Isolant souple ASGLASIL 15 x 500 x 1000

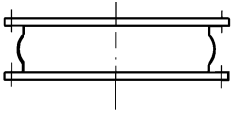

3.101

Nr.	Bezeichnung	Bestell-Nr. Order No. N° de commande	Preis EUR (o. MwSt.)
2.912	Ansaugflansch Fremdluftansaugung		
	WL5-PA DN 80	240 050 0103 2	
	WL5, WG5 DN 70	230 051 0002 0	
	W10-D DN 110	240 100 0016 0	
	W20-C DN 100	230 211 0002 0	
	WL30-C, WG30-C DN 150	240 301 0003 0	
	WL40/WG40 DN 150	240 401 0002 0	
	L1-RGL3	210 000 6701 2	
	L5-RGL5	110 564 0104 2	
	L7-RGMS8	110 764 0405 2	
	Ansaugflansch Fremdluftansaugung mit Luftdruckwächter		
	WG10 (mit W-FM05)	230 101 0023 0	
	WG10 Z (mit W-FM10 / W-FM20)	230 101 0024 0	
	WG20 (mit W-FM05)	230 211 0003 0	
	WG20 Z (mit W-FM10 / W-FM20)	230 211 0004 0	
	WG30-C (mit W-FM20)	230 311 0005 0	
	WGL30-C (mit W-FM 24)	230 311 0006 0	
	WG40 (mit W-FM20)	230 401 0004 0	
	WM-L10/1-A (nicht bei Drehzahlsteuerung)	201 101 0001 0	
	WM-L10/2-4A (nicht bei Drehzahlsteuerung)	201 101 0002 0	
	WM-G10/1-2A	250 101 0023 0	
	WM-G10/3+4A	250 101 0024 0	
	WM-L20 (nicht bei Drehzahlsteuerung)	210 201 0001 0	
	WM-GL10/1 + /2	250 101 0025 0	
	WM-GL10/3 + /4	250 101 0026 0	
	WM-G(L)20	250 201 0001 0	
	WM-L30/1+2	210 311 0001 0	
	WM-(G) L30/1+2	250 311 0001 0	
	WM-L30/3	210 311 0002 0	
	WM-(G) L30/3	250 311 0002 0	
3.	Gewebekompensatoren / Dichtschnur		
3.101	Gewebekompensator (zwischen Brenner und Luftkanal) mit Befestigungsteilen		
	WK4	170 405 0002 2	
	WK4 Heißluft	170 405 0003 2	
	WK40	270 405 0002 2	
	WK40 Heißluft	270 405 0003 2	
	WK50	270 505 0001 2	
	WK50 Heißluft	270 505 0002 2	
	WK70	270 705 0001 2	
	WK70 Heißluft	270 705 0002 2	
	WK 80	270 805 0001 2	
	WK 80 Heißluft	270 805 0002 2	
3.102	Dichtschnur (ohne Bild) 20 mm Ø, Preis je lfd. Meter 25 mm Ø, Preis je lfd. Meter	499 181	
		499 159	

No.	Description
2.912	<p>Intake flange ducted air intake</p> <p>WL5-PA DN 80 WL5, WG5 DN 70 W10-D DN 110 W20-C DN 100 WL30-C, WG30-C DN 150 WL40/WG40 DN 150</p> <p>L1-RGL3 L5-RGL5 L7-RGMS8</p> <p>Intake flange ducted air intake with air pressure switch</p> <p>WG10 (with W-FM05) WG10 Z (with W-FM10 / W-FM20) WG20 (with W-FM05) WG20 Z (with W-FM10 / W-FM20) WG30-C (with W-FM20) WGL30-C (with W-FM 24) WG40 (with W-FM20)</p> <p>WM-L10/1-A (not with speed control) WM-L10/2-4A (not with speed control) WM-G10/1-2A WM-G10/3+4A WM-L20 (not with speed control)</p> <p>WM-GL10/1 + /2 WM-GL10/3 + /4 WM-G(L)20</p> <p>WM-L30/1+2 WM-(G) L30/1+2 WM-L30/3 WM-(G) L30/3</p>
3.	Textile compensators / sealing cord
3.101	<p>Textile compensator (between burner and air duct) with fixing parts</p> <p>WK4 WK4 Hot air WK40 WK40 Hot air WK50 WK50 Hot air WK70 WK70 Hot air WK 80 WK 80 Hot air</p>
3.102	<p>Sealing cord (w/o pictures)</p> <p>20 mm Ø, price per metre 25 mm Ø, price per metre</p>

No.	Dénomination
2.912	<p>Bride pour aspiration air extérieur</p> <p>WL5-PA DN 80 WL5, WG5 DN 70 W10-D DN 110 W20-C DN 100 WL30-C, WG30-C DN 150 WL40/WG40 DN 150</p> <p>L1-RGL3 L5-RGL5 L7-RGMS8</p> <p>Bride pour aspiration air extérieur avec pressostat d'air</p> <p>WG10 (avec W-FM05) WG10 Z (avec W-FM10 / W-FM20) WG20 (avec W-FM05) WG20 Z (avec W-FM10 / W-FM20) WG30-C (avec W-FM20) WGL30-C (avec W-FM 24) WG40 (avec W-FM20)</p> <p>WM-L10/1-A (pas pour variation de vitesse) WM-L10/2-4A (pas pour variation de vitesse) WM-G10/1-2A WM-G10/3+4A WM-L20 (pas pour variation de vitesse)</p> <p>WM-GL10/1 + /2 WM-GL10/3 + /4 WM-G(L)20</p> <p>WM-L30/1+2 WM-(G) L30/1+2 WM-L30/3 WM-(G) L30/3</p>
3.	Compensateur / Cordon d'isolation
3.101	<p>Compensateur (entre brûleur et canal d'air) avec éléments de fixation</p> <p>WK4 WK4 air chaud WK40 WK40 air chaud WK50 WK50 air chaud WK70 WK70 air chaud WK 80 WK 80 air chaud</p>
3.102	<p>Cordon d'isolation (sans image)</p> <p>20 mm Ø, prix au mètre 25 mm Ø, prix au mètre</p>

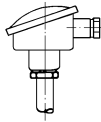
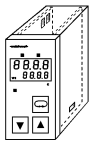

4.101

4.102

4.103 - 4.104

Nr.	Bezeichnung	Bestell-Nr. Order No. N° de commande	Preis EUR (o. MwSt.)
4.	Regler		
4.1	Regelgerät KS 40-108 (für zweistufige, dreistufige und modulierende Brenner) Außenabmessung: Front 96 x 48 mm, Einbautiefe 118 mm, Einbauausschnitt: 92+0,8 x 45+0,6 mm, zul. Temperaturbereich: 0...max. 60 °C Betrieb, Schutzart nach DIN 40050 (IEC 529) Frontseite IP 65, Gehäuse IP 20		
4.101	Ausgang: 3 Relaisausgänge, zuzuordnen über die Gerätekonfiguration Speisung des Messumformers P 30-w 18 V= Eingang: multifunktionaler Eingang über die Gerätekonfiguration auszuwählen z. B.: PT 100 0 - 400 °C Thermoelement Typ L 0 - 900 °C Typ K 0-1350 °C Spannungseingang (Druckaufnehmer P 30-w) 0...10 V Ferngeber 50 - 30 - 50 Ω Hilfsenergie 90V...260V AC, 48...62Hz	690 345	
	Regelgerät KS 40-102 (für Brenner mit analogem Leistungseingang z.B. W-FM 100/200, DLU, Parallellauf) Außenabmessung: Front 96 x 48 mm, Einbautiefe 118 mm, Einbauausschnitt: 92+0,8 x 45+0,6 mm, zul. Temperaturbereich: 0...max. 60 °C Betrieb, Schutzart nach DIN 40050 (IEC 529) Frontseite IP 65, Gehäuse IP 20 Hilfsenergie 90V...260V AC, 48...62 Hz		
	Ausgang: 2 Relaisausgänge, 1 analoger Ausgang 0/2-10V oder 0/4-20mA Speisung des Messumformers P30-w 18V= Eingang 1: multifunktionaler Eingang über die Gerätekonfiguration auszuwählen z. B.: PT 100 -200 - 850 °C Thermoelement Typ L, J, K, N, S, R Spannungseingang (Druckaufnehmer P 30-w) 0/2...10 V Stromeingang 0/4...20 mA Eingang 2: analoger Stromeingang 0/4-20 mA (ext. Sollwertvorgabe)	690 349	
4.102	Druckmessumformer S05 P 30-w Ausgangssignal: 0 - 10 V; Druckanschluss: G 1/2 n. DIN EN 837 Schlüsselweite: SW 24; Elektr. Anschluss: Leitungsdose DIN 43650/A Spannungs-Versorgung: DC 11,5 - 30 V 0 - 1 bar 0 - 16 bar 0 - 40 bar	690 432 690 433 690 434	
	Druckmessumformer S05 P 30-w Ausgangssignal: 4 - 20 mA 0 - 1 bar 0 - 16 bar 0 - 40 bar	690 435 690 436 690 437	
4.103	Widerstands-Temperaturfühler Pt 100 DIN 60751 Kl. B Bereich 50 - 400 °C, mit Meßgeber 1 x PT 100 PCA Meßwiderstand, Anschlusskopf Form B Alu-Druckguß mit M20 x 1,5 Kabelverschraubung Schutzrohr ø 9 mm; Werkstoff 1.2571; Anschluß G 1/2 A und Kupferdichtung DIN 7603 - A21 x 26 x 1,5 Schutzrohr 200 mm lang Schutzrohr 400 mm lang	691 161 691 162	
4.104	Widerstands-Temperaturfühler Pt100 DIN 43 729 FormB Bereich 50 - 400 °C, mit Messwertgeber 1x Pt100, geprüft nach DIN 3440 Einschweißhülse M 24 x 1,5, Länge 200 mm	691 123	
4.105	Temperaturfühler (Thermoelement) Form B (typ L) Fe-CuNi -200 bis 600 °C mit eingebautem Thermopaar, Schutzrohr aus hitzebeständigem Stahl 22 x 2 mm, mit Innenrohr aus Keramik, Nennlänge 500 mm (Ausgleichsleistung erforderlich)	691 124	
4.106	Temperaturfühler (Thermoelement) Form A (Typ K) Ni-Cr-Ni -200 bis 1150 °C mit eingebautem Thermopaar, Schutzrohr aus hitzebeständigem Stahl 22 x 2 mm, mit Innenrohr aus Keramik, Nennlänge 500 mm (Ausgleichsleistung erforderlich)	691 125	
60			

No.	Description
4.	Controllers
4.1	Controller KS 40-108 (for two stage, three stage and modulating burners) Outer dimensions: facial 96 x 46 mm, intrusion into the panel 118 mm Panel door cut out: 92+0.8 x 45+0.6 mm Permitted temperature range: 0...60 °C in operation, Protection class to DIN 40050 (IEC529), front IP 65, housing IP 20
4.101	Output: 3 relay outputs, matched according to unit configuration Feed for measurement transducer P 30-w 18V= Input: Multifunctional input selected according to unit configuration, i.e. Pt 100 0-400 °C Thermocouple type L 0-900 °C type K 0-1350 °C Voltage input (pressure input P 30-w) 0...10 V Remote transmitter 50 - 30 - 50 Ω Auxiliary energy 90V...260V AC, 48...62Hz
	Controller KS 40-102 (for burners with analogue load input, i.e. W-FM 100/200, DLU, parallel run) Outer dimensions: facial 96 x 46 mm, intrusion into the panel 118 mm Panel door cut out: 92+0.8 x 45+0.6 mm Permitted temperature range: 0...60 °C in operation, Protection class to DIN 40050 (IEC529), front IP 65, housing IP 20 Auxiliary energy 90V...260V AC, 48...62Hz
	Output: 2 relay outputs, 1 analogue output 0/2 - 10 V or 0/4 - 20mA Feed for measurement transducer P 30-w 18V= Input 1: Multifunctional input selected according to unit configuration, i.e. PT100 -200 - 850 °C Thermocouple type L, J, K, N, S, R Voltage input (pressure input P 30-w) 0/2...10V Current input 0/4...20mA Input 2: Analogue current input 0/4 - 20mA (ext. set value setting)
4.102	Press. measurement transducer S05 P 30-w Output signal: 0 - 10 V; press. conn: G 1/2 n. DIN EN 837 Spanner size: SW 24; Electr. conn.: socket DIN 43650/A Voltage supply: DC 11,5 - 30 V 0 - 1 bar 0 - 16 bar 0 - 40 bar
	Press. measurement transducer S05 P 30-w Output signal: 4 - 20 mA 0 - 1 bar 0 - 16 bar 0 - 40 bar
4.103	Resistance temperature sensor PT 100 PT 100 DIN 60751 Cl. B Range 50 - 400 °C, with 1x Pt100 PCA measurement resistance, connection head form B pressure dye cast alu with M20 x 1.5 cable gland protective sleeve Ø 9mm x G1/2 m connection and copper seal to DIN 7603-A21 x 26 x 1.5 protective sleeve length 200 mm long protective sleeve length 400 mm long
4.104	Resistance temperature sensor PT 100 DIN 43729 Form B Range 50 - 400 °C, with 1 x PT 100, tested to DIN 3340 welded sleeve M24 x 1.5 x 200 mm long
4.105	Temperature sensor (type L thermocouple) FE-CuNi - 200 °C to 600 °C with integral thermopair, protective sleeve in heat resisting steel 22 x 2 mm with ceramic inner tube nominal length 500 mm (compensating cable required)
4.106	Temperature sensor (type K thermocouple) Ni-Cr-Ni - 200 °C to 1150 °C with integral thermopair, protective sleeve in heat resisting steel 22 x 2 mm with ceramic inner tube nominal length 500 mm (compensating cable required)

No.	Dénomination
4.	Régulateurs
4.1	Régulateur KS 40-108 (pour brûleurs 2 ou 3 allures et modulateurs) Dimensions : frontale 96 x 48 mm, profondeur de montage 118 mm, Découpe : 92+0,8 x 45+0,6 mm, Température admissible : 0...max. 60 °C en fonctionnement, Indice de protection selon DIN 40050 (IEC 529) frontale IP 65, boîtier IP 20
4.101	Sortie : 3 sorties relais, affectés à la configuration de l'appareil Alimentation du convertisseur P 30-w 18 V= Entrée : Entrée multifonc. à déterminer par la config. de l'appareil par ex. : PT 100 0 - 400 °C Thermo-couple Type L 0 - 900 °C Type K 0-1350 °C Entrée tension (transmetteur P 30-w) 0...10 V Transmetteur potentiométrique 50 - 30 - 50 Ω Energie de secours 90V...260V AC, 48...62Hz
	Régulateur KS 40-102 (pour br. avec entrée analog. par ex. W-FM 100/200, DLU, marche para.) Dimensions : frontale 96 x 48 mm, profondeur de montage 118 mm, Découpe : 92+0,8 x 45+0,6 mm, Température admissible : 0...max. 60 °C en fonctionnement, Indice de protection selon DIN 40050 (IEC 529) frontale IP 65, boîtier IP 20 Energie de secours 90V...260V AC, 48...62 Hz
	Sortie : 2 relais de sortie, 1 sortie analogique 0/2-10V ou 0/4-20mA Alimentation du convertisseur P30-w 18V= Entrée 1 : Entrée multif. à déterm. par la conf. de l'appareil par ex. PT 100 -200 - 850 °C Thermo-couple Type L, J, K, N, S, R Entrée tension (transmetteur P 30-w) 0/2...10 V Entrée courant 0/4...20 mA Entrée 2 : Entrée analogique 0/4-20 mA (consigne externe)
4.102	Convertisseur de pression S05 P 30-w Signal de sortie : 0 - 10 V; raccord pression G 1/2 selon DIN EN 837 Clé de 24 ; raccordement électrique : DIN 43650/A Tension d'alimentation : DC 11,5 - 30 V 0 - 1 bar 0 - 16 bar 0 - 40 bar
	Convertisseur de pression S05 P 30-w Signal de sortie : 4 - 20 mA 0 - 1 bar 0 - 16 bar 0 - 40 bar
4.103	Sonde de température (résistance variable) Pt 100 DIN 60751 borne B Plage 50 - 400 °C, avec indicateur 1 x PT 100 Élément de mesure PCA, tête de raccordement forme B Fonte d'aluminium avec presse-étoupe M20 x 1,5 Doigt de gant ø 9 mm; matériau 1.2571; raccord G 1/2 A et joint plat en cuivre DIN 7603 - A21 x 26 x 1,5 doigt de gant longueur 200 mm doigt de gant longueur 400 mm
4.104	Sonde de température (résistance variable) Pt100 DIN 43 729 forme B Plage 50 - 400 °C, avec indicateur 1x Pt100, certifiée selon DIN 3440 Doigt de gant à souder M 24 x 1,5, longueur 200 mm
4.105	Sonde de température (thermo-couple) forme B (type L) Fe-CuNi -200 à 600 °C avec thermo-couple incorporé, doigt de gant en acier émaillé 22 x 2 mm, avec tube intérieur en céramique, longueur 500 mm (câbles de compensation nécessaires)
4.106	Sonde de température (thermo-couple) forme A (type K) Ni-Cr-Ni -200 à 1150 °C avec thermo-couple incorporé, doigt de gant en acier émaillé 22 x 2 mm, avec tube intérieur en céramique, longueur 500 mm (câbles de compensation nécessaires)

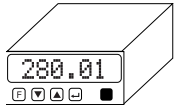

4.201

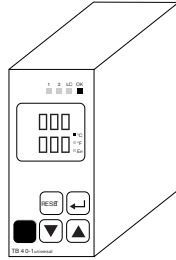

4.202

Nr.	Bezeichnung	Bestell-Nr. Order-No. N° de commande	Preis EUR (o.MWSt.)
4.107	Ausgleichsleitungen (ohne Bild) Preis pro Meter CuNi Ni-Cr-Ni	690 127 690 128	
4.108	Stecksocket KS 40 für Normschiene EN 50022	690 346	
4.109	Messumformer Uniflex CI 45	690 391	
4.110	Trennwandler P15000 für Parallelbetrieb (pro Brenner 1 Stück)	690 569	
4.2	Digital-Anzeigegerät		
4.201	Digitalanzeiger DIG 280-1 90-260 V; 48-62 Hz	690 591	
4.202	Temperaturbegrenzer TB 40-1 (DIN 3440) 90-260 V; 48-60 Hz	690 592	
	Temperaturbegrenzer TB 40-1 (Sonder, UL-zertifiziert) 90-260 V; 48-60 Hz	690 593	
	Bei Bestellung Sprache auswählen		
	Bedienungsanleitung TB40 - 1 deutsch	690 594	
	Bedienungsanleitung TB40 - 1 englisch	690 595	
	Bedienungsanleitung TB40 - 1 französisch	690 596	
	Bedienungsanleitung DIG280 - 1 deutsch	690 597	
	Bedienungsanleitung DIG280 - 1 englisch	690 598	
	Bedienungsanleitung DIG280 - 1 französisch	690 599	
4.203	Gehäuse für ABE WFM 50/100/200	217 706 1255 2	
4.204	Can Bus Kabel WFM 100/200	743 192	
4.205	Verlängerungskabel 10 m ABE WFM 50/54 (max. 20 m gesamt)	600 407	

No.	Designation	No.	Dénomination
4.107	Compensating cables (without picture) price per meter Fe-CuNi Ni-Cr-Ni	4.107	Câbles de compensation (sans photo) prix au mètre CuNi Ni-Cr-Ni
4.108	Plug socket KS40 for DIN rail EN 500022	4.108	Entretoise KS 40 pour rail EN 50022
4.109	Measurement transducer Uniflex CI	4.109	Convertisseur Uniflex CI
4.110	Transducer P15000 for parallel operation (1 per burner)	4.110	Séparateur de signal P15000 pour fonctionnement parallèle (1 pièce par brûleur)
4.2	Digital display units	4.2	Indicateur digital
4.201	DIG 280-1 digital display 90-260 V; 48-62 Hz	4.201	Indicateur digital DIG 280-1 90-260 V; 48-62 Hz
4.202	TB 40-1 temperature level controller (DIN 3440) 90-260 V; 48-60 Hz TB 40-1 temperature level controller (special, UL certificated) 90-260 V; 48-60 Hz Stipulate language when ordering Operating instructions TB40 – 1 German Operating instructions TB40 – 1 English Operating instructions TB40 – 1 French Operating instructions DIG280 – 1 German Operating instructions DIG280 – 1 English Operating instructions DIG280 – 1 French	4.202	Limiteur de température TB 40-1 (DIN 3440) 90-260 V; 48-60 Hz Limiteur de température TB 40-1 (Spécial, certifié UL) 90-260 V; 48-60 Hz A la commande, indiquer la langue Notice d'utilisation TB40 – 1 allemand Notice d'utilisation TB40 – 1 anglais Notice d'utilisation TB40 – 1 français Notice d'utilisation DIG280 – 1 allemand Notice d'utilisation DIG280 – 1 anglais Notice d'utilisation DIG280 – 1 français
4.203	Housing for ABE WFM 50/100/200	4.203	Corps pour ABE WFM 50/100/200
4.204	Can Bus cable WFM 100/200	4.204	Câble Can bus WFM 100/200
4.205	Extension cable 10 m ABE WFM 50/54 (total max. 20 m)	4.205	Rallonge de câble 10 m ABE WFM 50/54 (max. 20 m au total)

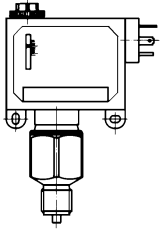

5.101-5.301

Nr.	Bezeichnung	Bestell-Nr. Order-No. No de commande	Preis EUR (o.MWSt.)																								
5	Dampfdruckwächter																										
5.1	Dampfdruck NDD bis 0,5 bar																										
	<p>Dampfdruckwächter mit Umschaltkontakt 8A/250V Gehäuseunterteil aus Aluminium-Druckguss Schutzart IP54, Anschlussgewinde G 1/2" Zulässige Umgebungstemperatur -25 bis +70 °C TÜV-Baumustergeprüft (Reg.-Nr. 3 C 02805)</p>																										
	<table border="1"> <thead> <tr> <th>Typ</th> <th>Einstell- bereich bar</th> <th>Schalt- differenz bar</th> <th>Max. zul. Druck bar</th> </tr> </thead> <tbody> <tr> <td>5.101 DRW 06</td> <td>0,1 - 0,6</td> <td>0,04</td> <td>6</td> </tr> </tbody> </table>	Typ	Einstell- bereich bar	Schalt- differenz bar	Max. zul. Druck bar	5.101 DRW 06	0,1 - 0,6	0,04	6	640 114																	
Typ	Einstell- bereich bar	Schalt- differenz bar	Max. zul. Druck bar																								
5.101 DRW 06	0,1 - 0,6	0,04	6																								
5.2	Dampfdruck HDD über 0,5 bar																										
	<p>Dampfdruckwächter mit Umschaltkontakt 10A/380V Gehäuseunterteil aus Aluminium-Spritzguss Abdeckhaube aus transparentem Thermoplast Schutzart IP65, Anschlussgewinde G 1/2" Zulässige Umgebungstemperatur -20 bis +70 °C Druckfühler aus Messing für nichtaggressive Medien TÜV-Baumustergeprüft (Reg.-Nr. 3 C 03705) flüssige Brennstoffe</p>																										
	<table border="1"> <thead> <tr> <th>Typ</th> <th>Einstell- bereich bar</th> <th>Schalt- differenz bar</th> <th>Max. zul. Druck bar</th> </tr> </thead> <tbody> <tr> <td>5.201 DSB 140</td> <td>0 - 2,5</td> <td>0,25 - 0,75</td> <td>12</td> </tr> <tr> <td>DSB 143</td> <td>0 - 6</td> <td>0,3 - 1,6</td> <td>16</td> </tr> <tr> <td>DSB 152</td> <td>6 - 16</td> <td>1,0 - 4,0</td> <td>30</td> </tr> <tr> <td>DSB 158</td> <td>0 - 25</td> <td>1,0 - 7,5</td> <td>60</td> </tr> <tr> <td>DSB 170</td> <td>5 - 40</td> <td>1,4 - 7,5</td> <td>60</td> </tr> </tbody> </table>	Typ	Einstell- bereich bar	Schalt- differenz bar	Max. zul. Druck bar	5.201 DSB 140	0 - 2,5	0,25 - 0,75	12	DSB 143	0 - 6	0,3 - 1,6	16	DSB 152	6 - 16	1,0 - 4,0	30	DSB 158	0 - 25	1,0 - 7,5	60	DSB 170	5 - 40	1,4 - 7,5	60	640 110 640 105 640 106 640 103 640 107	
Typ	Einstell- bereich bar	Schalt- differenz bar	Max. zul. Druck bar																								
5.201 DSB 140	0 - 2,5	0,25 - 0,75	12																								
DSB 143	0 - 6	0,3 - 1,6	16																								
DSB 152	6 - 16	1,0 - 4,0	30																								
DSB 158	0 - 25	1,0 - 7,5	60																								
DSB 170	5 - 40	1,4 - 7,5	60																								
	<p>Dampfdruckwächter mit elektrischer Verriegelung Gehäuseunterteil aus Aluminium-Spritzguss Abdeckhaube aus transparentem Thermoplast Schutzart IP65, Anschlussgewinde G 1/2" Zulässige Umgebungstemperatur -20 bis +70 °C Als Sicherheitsdruckbegrenzer in Verbindung mit Ruhestrom- Verriegelungsschaltung zugelassen. Druckfühler aus Nirostahl für aggressive Medien TÜV-Baumustergeprüft und plombierbar (Reg.-Nr. 3 C 03705) flüssige Brennstoffe</p>																										
	<table border="1"> <thead> <tr> <th>Typ</th> <th>Einstell- bereich bar</th> <th>Schalt- differenz bar</th> <th>Max. zul. Druck bar</th> </tr> </thead> <tbody> <tr> <td>5.202 DSF 152</td> <td>0 - 16</td> <td>1,2 - 3,8</td> <td>60</td> </tr> <tr> <td>DSF 158</td> <td>0 - 25</td> <td>1,5 - 8,0</td> <td>60</td> </tr> <tr> <td>DSF 170</td> <td>15 - 40</td> <td>1,7 - 8,2</td> <td>60</td> </tr> </tbody> </table>	Typ	Einstell- bereich bar	Schalt- differenz bar	Max. zul. Druck bar	5.202 DSF 152	0 - 16	1,2 - 3,8	60	DSF 158	0 - 25	1,5 - 8,0	60	DSF 170	15 - 40	1,7 - 8,2	60	640 108 640 109 640 113									
Typ	Einstell- bereich bar	Schalt- differenz bar	Max. zul. Druck bar																								
5.202 DSF 152	0 - 16	1,2 - 3,8	60																								
DSF 158	0 - 25	1,5 - 8,0	60																								
DSF 170	15 - 40	1,7 - 8,2	60																								
5.203	Spannmuffe G 1/2" x 1/2" mit gegenlaufenden Gewinden, DIN 16 283, für Anlagen nach TRD (ohne Bild)	640 083																									
5.3	Heißwasser über 110 °C, Minimal-Druck																										
	<p>Minimal-Druckbegrenzer mit eingebauter mechanischer Verriegelung Gehäuseunterteil aus Aluminium-Spritzguss Abdeckhaube aus transparentem Thermoplast Schutzart IP65, Anschlussgewinde G 1/2" Zulässige Umgebungstemperatur -20 bis +70 °C Druckfühler aus Nirostahl für aggressive Medien TÜV-Baumustergeprüft (Reg.-Nr. 3 C 03705) flüssige Brennstoffe</p>																										
	<table border="1"> <thead> <tr> <th>Typ</th> <th>Einstell- bereich bar</th> <th>Schalt- differenz bar</th> <th>Max. zul. Druck bar</th> </tr> </thead> <tbody> <tr> <td>5.301 DSL 152</td> <td>6 - 16</td> <td>1,2</td> <td>30</td> </tr> </tbody> </table>	Typ	Einstell- bereich bar	Schalt- differenz bar	Max. zul. Druck bar	5.301 DSL 152	6 - 16	1,2	30	640 112																	
Typ	Einstell- bereich bar	Schalt- differenz bar	Max. zul. Druck bar																								
5.301 DSL 152	6 - 16	1,2	30																								

No.	Designation																																								
5.	System pressure switches																																								
5.1	Steam pressure, low pressure steam up to 0.5 bar																																								
	<p>Steam pressure switch with change-over contact 8A/250V Casing base of die cast aluminium Type of protection IP54, connection thread G 1/2" Temperature range -25 °C to +70 °C TUV-type-approved (Reg.-No 3 C 02805)</p> <table border="1"> <thead> <tr> <th>Type</th> <th>Adjustment range bar</th> <th>Switching difference bar</th> <th>Max.-admissible pressure bar</th> </tr> </thead> <tbody> <tr> <td>5.101 DRW 06</td> <td>0,1 - 0,6</td> <td>0,04</td> <td>6</td> </tr> </tbody> </table>	Type	Adjustment range bar	Switching difference bar	Max.-admissible pressure bar	5.101 DRW 06	0,1 - 0,6	0,04	6																																
Type	Adjustment range bar	Switching difference bar	Max.-admissible pressure bar																																						
5.101 DRW 06	0,1 - 0,6	0,04	6																																						
5.2	Steam pressure, high pressure steam above 0.5 bar																																								
	<p>Steam pressure switch with change-over contact 10A/250V Casing base of die cast aluminium Cover of transparent Thermoplastic Type of protection IP65, connection thread G 1/2" Temperature range -20 °C to +70 °C Brass pressure sensor for non-aggressive media TUV-type-approved (Reg.-No 3 C 03705) liquid fuels</p> <table border="1"> <thead> <tr> <th>Type</th> <th>Adjustment range bar</th> <th>Switching difference bar</th> <th>Max. admissible pressure bar</th> </tr> </thead> <tbody> <tr> <td>5.201 DSB 140</td> <td>0 - 2,5</td> <td>0,25 - 0,75</td> <td>12</td> </tr> <tr> <td>DSB 143</td> <td>0 - 6</td> <td>0,3 - 1,6</td> <td>16</td> </tr> <tr> <td>DSB 152</td> <td>6 - 16</td> <td>1,0 - 4,0</td> <td>30</td> </tr> <tr> <td>DSB 158</td> <td>0 - 25</td> <td>1,0 - 7,5</td> <td>60</td> </tr> <tr> <td>DSB 170</td> <td>5 - 40</td> <td>1,4 - 7,5</td> <td>60</td> </tr> </tbody> </table> <p>Steam pressure switch with electrical interlocking Casing base of die cast aluminium Cover of transparent Thermoplastic Type of protection IP65, connection thread G 1/2" Temperature range -20 °C to +70 °C A closed circuit current interlocking switching system is required Ni-ro steel pressure sensor for aggressive media TUV-type-approved with lead seal (Reg.-No 3 C 03705) liquid fuels</p> <table border="1"> <thead> <tr> <th>Type</th> <th>Adjustment range bar</th> <th>Switching difference bar</th> <th>Max. admissible pressure bar</th> </tr> </thead> <tbody> <tr> <td>5.202 DSF 152</td> <td>0 - 16</td> <td>1,2 - 3,8</td> <td>60</td> </tr> <tr> <td>DSF 158</td> <td>0 - 25</td> <td>1,5 - 8,0</td> <td>60</td> </tr> <tr> <td>DSF 170</td> <td>15 - 40</td> <td>1,7 - 8,2</td> <td>60</td> </tr> </tbody> </table>	Type	Adjustment range bar	Switching difference bar	Max. admissible pressure bar	5.201 DSB 140	0 - 2,5	0,25 - 0,75	12	DSB 143	0 - 6	0,3 - 1,6	16	DSB 152	6 - 16	1,0 - 4,0	30	DSB 158	0 - 25	1,0 - 7,5	60	DSB 170	5 - 40	1,4 - 7,5	60	Type	Adjustment range bar	Switching difference bar	Max. admissible pressure bar	5.202 DSF 152	0 - 16	1,2 - 3,8	60	DSF 158	0 - 25	1,5 - 8,0	60	DSF 170	15 - 40	1,7 - 8,2	60
Type	Adjustment range bar	Switching difference bar	Max. admissible pressure bar																																						
5.201 DSB 140	0 - 2,5	0,25 - 0,75	12																																						
DSB 143	0 - 6	0,3 - 1,6	16																																						
DSB 152	6 - 16	1,0 - 4,0	30																																						
DSB 158	0 - 25	1,0 - 7,5	60																																						
DSB 170	5 - 40	1,4 - 7,5	60																																						
Type	Adjustment range bar	Switching difference bar	Max. admissible pressure bar																																						
5.202 DSF 152	0 - 16	1,2 - 3,8	60																																						
DSF 158	0 - 25	1,5 - 8,0	60																																						
DSF 170	15 - 40	1,7 - 8,2	60																																						
5.203	Sleeve G 1/2" x G 1/2" with lh/rh thread DIN 16 283, for installations to TRD 604 (without picture)																																								
5.3	Hot water above 110 °C, minimum pressure																																								
	<p>Minimum pressure limiter with integral mechanical interlock Casing base of die cast aluminium Cover of transparent Thermoplastic Type of protection IP65, connection thread G 1/2" Temperature range -20 °C to +70 °C Ni-ro steel pressure sensor for aggressive media TUV-type-approved (Reg.-No 3 C 03705) liquid fuels,</p> <table border="1"> <thead> <tr> <th>Type</th> <th>Adjustment range bar</th> <th>Switching difference bar</th> <th>Max. admissible pressure bar</th> </tr> </thead> <tbody> <tr> <td>5.301 DSL 152</td> <td>6 - 16</td> <td>1,2</td> <td>30</td> </tr> </tbody> </table>	Type	Adjustment range bar	Switching difference bar	Max. admissible pressure bar	5.301 DSL 152	6 - 16	1,2	30																																
Type	Adjustment range bar	Switching difference bar	Max. admissible pressure bar																																						
5.301 DSL 152	6 - 16	1,2	30																																						

No.	Dénomination																																								
5	Surveillance de pression chaudière																																								
5.1	Vapeur basse pression jusqu'à 0,5 bar																																								
	<p>Pressostat avec contact inverseur 8A/250V Carcasse inférieure en fonte d'aluminium Indice de protection IP54, raccord G 1/2" Température ambiante admissible -25 jusqu'à +70 °C Certifié TÜV (N° certificat. 3 C 02805)</p> <table border="1"> <thead> <tr> <th>Type</th> <th>Plage de réglage bar</th> <th>Différentiel de commutation bar</th> <th>Pression max. admissible bar</th> </tr> </thead> <tbody> <tr> <td>5.101 DRW 06</td> <td>0,1 - 0,6</td> <td>0,04</td> <td>6</td> </tr> </tbody> </table>	Type	Plage de réglage bar	Différentiel de commutation bar	Pression max. admissible bar	5.101 DRW 06	0,1 - 0,6	0,04	6																																
Type	Plage de réglage bar	Différentiel de commutation bar	Pression max. admissible bar																																						
5.101 DRW 06	0,1 - 0,6	0,04	6																																						
5.2	Vapeur haute pression supérieure à 0,5 bar																																								
	<p>Pressostat avec contact inverseur 10A/380V Partie inférieure du boîtier en fonte d'aluminium Capot en matière plastique transparente Indice de protection IP65, raccord G 1/2" Température ambiante admissible -20 jusqu'à +70 °C Sonde en laiton pour fluides non agressifs Certifié TÜV (N° cert. 3 C 03705) comb. liquides</p> <table border="1"> <thead> <tr> <th>Type</th> <th>Plage de réglage bar</th> <th>Différentiel de commutation bar</th> <th>Pression max. admissible bar</th> </tr> </thead> <tbody> <tr> <td>5.201 DSB 140</td> <td>0 - 2,5</td> <td>0,25 - 0,75</td> <td>12</td> </tr> <tr> <td>DSB 143</td> <td>0 - 6</td> <td>0,3 - 1,6</td> <td>16</td> </tr> <tr> <td>DSB 152</td> <td>6 - 16</td> <td>1,0 - 4,0</td> <td>30</td> </tr> <tr> <td>DSB 158</td> <td>0 - 25</td> <td>1,0 - 7,5</td> <td>60</td> </tr> <tr> <td>DSB 170</td> <td>5 - 40</td> <td>1,4 - 7,5</td> <td>60</td> </tr> </tbody> </table> <p>Pressostat vapeur avec verrouillage électrique Partie inférieure du boîtier en fonte d'aluminium Capot en matière plastique transparente Indice de protection IP65, raccord G 1/2" Température ambiante admissible -20 jusqu'à +70 °C En tant que limiteur de pression et certifié en liaison avec verrouillage par Sonde en acier inoxydable pour fluides agressifs manque de tension. Certifié TÜV et plombé (N° certificat 3 C 03705) combustibles liquides</p> <table border="1"> <thead> <tr> <th>Type</th> <th>Plage de réglage bar</th> <th>Différentiel de commutation bar</th> <th>Pression max. admissible bar</th> </tr> </thead> <tbody> <tr> <td>5.202 DSF 152</td> <td>0 - 16</td> <td>1,2 - 3,8</td> <td>60</td> </tr> <tr> <td>DSF 158</td> <td>0 - 25</td> <td>1,5 - 8,0</td> <td>60</td> </tr> <tr> <td>DSF 170</td> <td>15 - 40</td> <td>1,7 - 8,2</td> <td>60</td> </tr> </tbody> </table>	Type	Plage de réglage bar	Différentiel de commutation bar	Pression max. admissible bar	5.201 DSB 140	0 - 2,5	0,25 - 0,75	12	DSB 143	0 - 6	0,3 - 1,6	16	DSB 152	6 - 16	1,0 - 4,0	30	DSB 158	0 - 25	1,0 - 7,5	60	DSB 170	5 - 40	1,4 - 7,5	60	Type	Plage de réglage bar	Différentiel de commutation bar	Pression max. admissible bar	5.202 DSF 152	0 - 16	1,2 - 3,8	60	DSF 158	0 - 25	1,5 - 8,0	60	DSF 170	15 - 40	1,7 - 8,2	60
Type	Plage de réglage bar	Différentiel de commutation bar	Pression max. admissible bar																																						
5.201 DSB 140	0 - 2,5	0,25 - 0,75	12																																						
DSB 143	0 - 6	0,3 - 1,6	16																																						
DSB 152	6 - 16	1,0 - 4,0	30																																						
DSB 158	0 - 25	1,0 - 7,5	60																																						
DSB 170	5 - 40	1,4 - 7,5	60																																						
Type	Plage de réglage bar	Différentiel de commutation bar	Pression max. admissible bar																																						
5.202 DSF 152	0 - 16	1,2 - 3,8	60																																						
DSF 158	0 - 25	1,5 - 8,0	60																																						
DSF 170	15 - 40	1,7 - 8,2	60																																						
5.203	Entretoise G 1/2" x 1/2" avec raccords, DIN 16 283, pour installations selon TRD (sans photo)																																								
5.3	Eau surch. supérieure à 110 °C, pression min.																																								
	<p>Pressostat mini avec verrouillage mécanique incorporé Partie inférieure du boîtier en fonte d'aluminium Capot en matière plastique transparente Indice de protection IP65, raccords G 1/2" Température ambiante admissible -20 jusqu'à +70 °C Sonde en acier inoxydable pour fluides agressifs Certifié TÜV (N° certificat 3 C 03705) combustibles liquides</p> <table border="1"> <thead> <tr> <th>Type</th> <th>Plage de réglage bar</th> <th>Différentiel de commutation bar</th> <th>Pression max. admissible bar</th> </tr> </thead> <tbody> <tr> <td>5.301 DSL 152</td> <td>6 - 16</td> <td>1,2</td> <td>30</td> </tr> </tbody> </table>	Type	Plage de réglage bar	Différentiel de commutation bar	Pression max. admissible bar	5.301 DSL 152	6 - 16	1,2	30																																
Type	Plage de réglage bar	Différentiel de commutation bar	Pression max. admissible bar																																						
5.301 DSL 152	6 - 16	1,2	30																																						

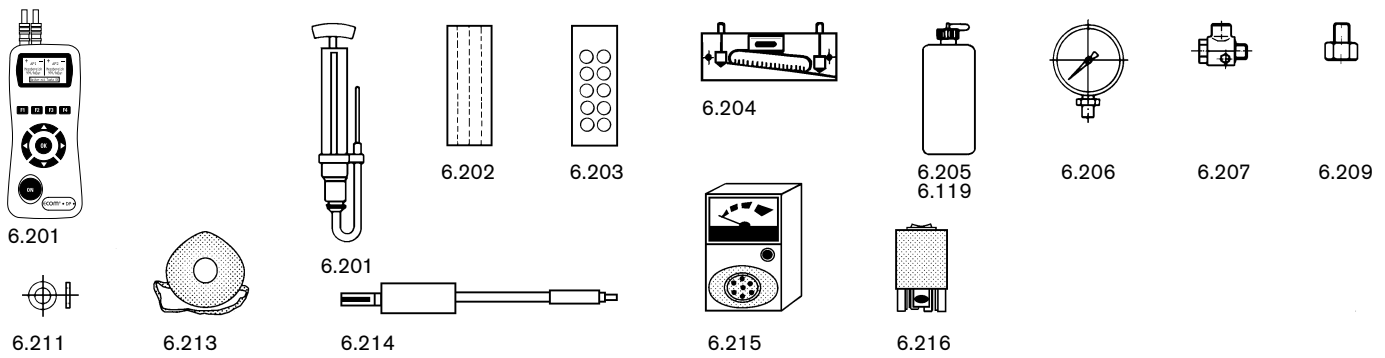

Nr.	Bezeichnung	Bestell-Nr. Order-No. No de commande	Preis EUR (o.MWSt.)																																				
6.	Mess- und Prüfgeräte																																						
6.101	Messgerät ecom-DP V2 kpl. Digitaler Druck- und Differenzdruckmesser +/- 1 bar mit Zubehör für Dichtheitsprüfung; Bestehend aus: Messgerät, Schlauchset, Kreuzstück Swagelok mit Hahn, Blasebalg und Kunststoffkoffer mit Einlage	669 443																																					
6.102	Messgerät ecom-DPV2 ohne Zubehör für Dichtheitsprüfung	669 411																																					
6.103	Entlüftungsschlauch kpl. G1/4 x 16m lang für Gasarmaturen (Phönix Unitrex 60 DN8 (R < 10 Megaohm/m)) bestehend aus: Schnellverschluß G1/4, Schlauch 15m, Kugelhahn G3/8 und Schlauch 1m	491 272																																					
6.104	Schlauchset für Messgerät ecom-DP V2 2 x diffusionsbeständige Schläuche, blau, 6 x 4, 1,6m lang 1 x diffusionsbeständigen Schlauch, grau, 6 x 4, 1,2m lang Steckschlauch, farblos, 6,3 x 3,1, 4cm 2 x Schläuche, farblos, 6,3 x 3,1, 8cm	669 444																																					
6.105	Kreuzstück für Messgerät ecom-DP V2 verschraubt Swagelok mit Hahn + Tülle, sowie Adapter SW, Dichtscheibe SW und Stopfen	669 445																																					
6.106	Koffer für Messgerät ecom-DP V2 mit Einlage	669 446																																					
6.107	Blasebalg für Messgerät ecom-DP V2 für Druckaufbau	669 416																																					
6.201	Rußmessgerät ET-AP205 zur Rußgehalt-Bestimmung in Abgasen, bestehend aus Absauggerät, Filterpapier und Rußbildskala	669 310																																					
6.202	Filterpapierstreifen 18 x 90 mm	669 359																																					
6.203	Rußbildskala ETS mit Hülle	669 313																																					
6.204	Zugmesser - 12 bis 1,2 mbar Schrägröhr-Ausführung mit Haltemagnet	669 039																																					
6.205	Messflüssigkeit für Zugmesser, 100 cm ³ Manometer Anschluss unten mit Rohrfeder in Standardausführung für flüssige und gasförmige Medien, Umgebungstemperatur max. 60 °C, Messstofftemperatur max. 170 °C	669 040																																					
6.206	<table border="1"> <thead> <tr> <th>Messbereich</th> <th>Anschluss G</th> <th>Gehäuse Ø mm</th> <th></th> </tr> </thead> <tbody> <tr> <td>0 bis 6</td> <td>1/4"</td> <td>63</td> <td>641 164</td> </tr> <tr> <td>0 bis 25</td> <td>1/4"</td> <td>63</td> <td>641 167</td> </tr> <tr> <td>0 bis 25</td> <td>1/4"</td> <td>63 (Anschluss hinten)</td> <td>641 169</td> </tr> <tr> <td>0 bis 40</td> <td>1/4"</td> <td>63</td> <td>641 168</td> </tr> <tr> <td>0 bis 40</td> <td>1/4"</td> <td>63 (Anschluss hinten)</td> <td>641 170</td> </tr> <tr> <td>0 bis 6*)</td> <td>1/4"</td> <td>63</td> <td>641 157</td> </tr> <tr> <td>0 bis 25*)</td> <td>1/4"</td> <td>63</td> <td>641 158</td> </tr> <tr> <td>0 bis 40*)</td> <td>1/4"</td> <td>63</td> <td>641 159</td> </tr> </tbody> </table> <p>* mit Glycerineinfüllung und Gehäuse aus Edelstahl Mehrpreis für temperaturbeständige Ausführung bis 200 °C (keine Kunststoffteile)</p>	Messbereich	Anschluss G	Gehäuse Ø mm		0 bis 6	1/4"	63	641 164	0 bis 25	1/4"	63	641 167	0 bis 25	1/4"	63 (Anschluss hinten)	641 169	0 bis 40	1/4"	63	641 168	0 bis 40	1/4"	63 (Anschluss hinten)	641 170	0 bis 6*)	1/4"	63	641 157	0 bis 25*)	1/4"	63	641 158	0 bis 40*)	1/4"	63	641 159		
Messbereich	Anschluss G	Gehäuse Ø mm																																					
0 bis 6	1/4"	63	641 164																																				
0 bis 25	1/4"	63	641 167																																				
0 bis 25	1/4"	63 (Anschluss hinten)	641 169																																				
0 bis 40	1/4"	63	641 168																																				
0 bis 40	1/4"	63 (Anschluss hinten)	641 170																																				
0 bis 6*)	1/4"	63	641 157																																				
0 bis 25*)	1/4"	63	641 158																																				
0 bis 40*)	1/4"	63	641 159																																				
6.207	Vakuumanometer Anschluss unten (mit Glycerinfüllung) - 1 bis + 5 1/4" 63 - 1 bis + 9 1/4" 63	641 154 641 155																																					
6.208	Manometeranschluss R1/8, für alle WL-Brenner	140 013 8505 2																																					
6.209	Manometerverlängerung G1/4 x G1/8 x 110 mm	111 351 8536 7																																					
6.210	Reduziernippel für Vakuummeter G1/4 x NPT 1/4"	111 351 8524 7																																					
6.211	Dichtung Ø 9,8 x 5,5 x 3,2	440 001																																					
6.212	Gummischlauch 5 x 1,5 6 x 1,5	669 029 669 030																																					
6.213	Atemschutzmaske	669 065																																					
6.214	Prüfadapter Ionisation WG20 Flammenfühler QRB1S	230 200 1205 2 240 100 1201 2																																					
6.215	Messgerät KF 8832 für Fühlerstrom, LGK mit QRA53/55	669 097																																					
6.216	Steckerschalter ST 18/4 WG10 - WGL30Z, WL20-WL30Z	130 103 1501 2																																					
6.217	U-Rohrmanometer 0-120 mbar	669 041																																					

No.	Designation
6.	Measuring and testing devices
6.101	Measuring device ecom-DP V2 cpl. digital press. + diff. press. meas. device +/- 1 bar with accessories for valve proving; consists of: measuring device, hose set, cross piece Swagelok will cock, bellows and plastic case with insert
6.102	Measuring device ecom-DPV2 without accessories for valve proving
6.103	Vent hose cpl. G1/4 x 16m long for gas valve trains (Phoenix Unitrex 60 DN8 (R < 10 Megaohm/m)) consisting of: quick release fastener G1/4, hose 15m, ball valve G3/8 and hose 1m
6.104	Hose set for measuring device ecom-DP V2 2 x diffusion resistant hoses, blue 6 x 4, 1.6m long 1 x diffusion resistant hose, grey 6 x 4, 1.2m long push-on hose, transparent, 6.3 x 3.1, 4cm 2 x hoses, transparent, 6.3 x 3.1, 8cm
6.105	Cross piece for measuring device ecom-DP V2 screwed Swagelok with cock + socket, as well as adapter SW, sealing washer SW and plug
6.106	Case for measuring device ecom-DP V2 with insert
6.107	Bellows for measuring device ecom-DP V2 for pressure build-up
6.201	Soot measuring device ET-AP205 to determine soot content in flue gas, consisting of suction device, filter paper and smoke number scale
6.202	Filter paper strips 18 x 90 mm
6.203	Smoke number scale ETS with sleeve
6.204	Draught gauge - 12 to 1.2 mbar Inclined pipe version with holding magnet
6.205	Measuring liquid for draught gauge, 100 cm ³ Pressure gauge connection at bottom with tubular springing standard version for liquid and gaseous media, ambient temperature max. 60 °C, measuring liquid temperature max. 170 °C measuring range connection G housing Ø mm 0 to 6 1/4" 63 0 to 25 1/4" 63 0 to 25 1/4" 63 (connection at rear) 0 to 40 1/4" 63 0 to 40 1/4" 63 (connection at rear) 0 to 6") 1/4" 63 0 to 25") 1/4" 63 0 to 40") 1/4" 63 * with Glycerine filling and stainless steel housing additional price for temperature resistant version up to 200 °C (no plastic parts)
6.207	Vacuum gauge connection at bottom (with Glycerine filling) - 1 to + 5 1/4" 63 - 1 to + 9 1/4" 63
6.208	Gauge connection R1/8, for all WL burners
6.209	Gauge extension G1/4 x G1/8 x 110 mm
6.210	Reducing nipple for vacuum gauge G1/4 x NPT 1/4"
6.211	Gasket Ø 9.8 x 5.5 x 3.2
6.212	Rubber hose 5 x 1.5 6 x 1.5
6.213	Respirator mask
6.214	Test adapter Ionisation WG20 Flame sensor QRB1S
6.215	Measuring device KF 8832 for sensor current, LGK w. QRA53/55
6.216	Plug switch ST 18/4 WG10 - WGL30Z, WL20-WL30Z
6.217	U tube manometer 0-120 mbar

No.	Dénomination
6.	Appareils de mesure et de contrôle
6.101	Manomètre digital ecom-DP V2 complet différentiel +/- 1 bar avec accessoires pour le contrôle d'étanchéité composé de : appareil de mesure, ensemble de tubes flexibles, croisillon avec robinet, soufflet et coffret de rangement.
6.102	Mallette de mesure ecom-DPV2 sans accessoire pour contrôle d'étanch.
6.103	Flexible mise à l'atmosphère cpl. G1/4 x 16m long. pour rampe gaz (Phönix Unitrex 60 DN8 (R < 10 Megaohm/m)) composé de : fermeture rapide G1/4, flexible 15m, robinet G3/8 avec flexible 1m
6.104	Ensemble tuyaux pour mallette de mesure ecom-DP V2 2 x tuyau souple, bleu, 6 x 4, long. 1,6m 1 x tuyau souple, gris, 6 x 4, long.1,2m Tuyau pour raccord souple, transparent, 6,3 x 3,1, 4cm 2 x flexibles, transparent, 6,3 x 3,1, 8cm
6.105	Connecteur 4 voies pour mallette de mesure ecom-DP V2 raccord avec robinet+ protection, et adaptateur SW, étanchéité SW et bouchon
6.106	Coffre pour mallette de mesure ecom-DP V2 avec manomètre digital
6.107	Poire de gonflage pour mallette ecom-DP V2 pour manomètre digital
6.201	Appareil de mesure Bacharach ET-AP205 pour déterminer la teneur en suie des fumées, comprenant aspiration, papier filtre et échelle comparative
6.202	Papier filtre de rechange 18 x 90 mm
6.203	Echelle comparative des fumées (rechange)
6.204	Déprimomètre - 12 à 1,2 mbar Tube incliné avec aimant de maintien
6.205	Liquide de mesure pour déprimomètre, 100 cm ³ Manomètre raccordement par le bas avec ressort en exécution standard pour fluides liquides et gazeux, Température ambiante max. 60 °C, température de mesure max. 170 °C Plage de mesure Raccord G Corps Ø mm 0 jusqu'à 6 1/4" 63 0 jusqu'à 25 1/4" 63 0 jusqu'à 25 1/4" 63 (raccordement arrière) 0 jusqu'à 40 1/4" 63 0 jusqu'à 40 1/4" 63 (raccordement arrière) 0 jusqu'à 6") 1/4" 63 0 jusqu'à 25") 1/4" 63 0 jusqu'à 40") 1/4" 63 * rempli de glycérine et corps en acier Plus-value pour exécution contenance thermique jusqu'à 200 °C (aucun élément plastique)
6.207	Vacuo/manomètre raccordement par le bas (rempli de glycérine) - 1 jusqu'à + 5 1/4" 63 - 1 jusqu'à + 9 1/4" 63
6.208	Raccord manomètre R1/8, pour tous les brûleurs WL
6.209	Rallonge manomètre G1/4 x G1/8 x 110 mm
6.210	Raccord de réduction pour vacuomètre G1/4 x NPT 1/4"
6.211	Joint Ø 9,8 x 5,5 x 3,2
6.212	Flexible caoutchouc 5 x 1,5 6 x 1,5
6.213	Masque de protection
6.214	Adaptateur ionisation WG20 cellule QRB1S
6.215	Mallette de mesure KF 8832 pour courant de cellule, LGK avec QRA53/55
6.216	Interrupteur ST 18/4 WG10 - WGL30Z, WL20-WL30Z
6.216	Tube U 0-120 mbar

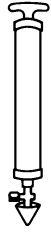

7.101-7.102

7.104

7.105

Nr.	Bezeichnung	Bestell-Nr. Order-No. No de commande	Preis EUR (o.MWSt.)
6.218	Messflüssigkeit für U-Rohrmanometer, 22 cm ³	669 067	
6.219	Messstellen Umschalter für 4 Messpunkte	669 412	
6.220	Silikonschlauch 3,5 x 2,0 transparent (Meterware)	750 418	
6.221	Druckmessnippel G 1/4" Druckmessnippel G 1/8"	453 005 453 001	
6.222	Vielfachmessgerät Typ Amprobe 37 x R-A komplett mit Tasche	669 413	
6.223	Sicherheitsmessleitung schwarz Sicherheitsmessleitung rot	669 054 669 055	
7.	Werkzeuge		
7.101	Werkzeugsatz , mit je 1 Sechskantschraubendreher DIN 911, für Zylinderschrauben mit Innensechskant, SW-4-5-6-7-8-10-17	699 014	
7.102	Werkzeug für Monarch-Brenner mit je 1 Gabelschlüssel DIN 3110 SW-8/10-12/13-11/14-16/17-19/22-22/24-27/32, Sechskantschraubenzieher 2,3/4,5, Kreuzschlitzschraubenzieher M5, Steckschlüssel SW8	111 151 0001 2	
7.103	Düsenkoffer Stabile Blechgehäuse zur Aufnahme von 64 Düsen, Außenmaße 230 x 230 x 45 mm (ohne Bild)	699 019	
	für 40 Fluidics-Rücklaufdüsen	699 024	
7.104	Ölansauger zum Füllen der Ölleitung zwischen Öltank und Brenner	669 021	
7.105	Gummikonus für Ölansauger	669 022	
7.106	Abziehvorrichtung W5 bis W40	699 023	
7.107	Abziehvorrichtung Gr. 1 - 8, 30 + 40, WM 10-30	111 111 0001 2	
7.108	Abziehvorrichtung Gr. 9 - 11, 50 - 70 Abziehvorrichtung Magnetkupplung	121 362 0013 2 155 907 0002 2	

No.	Designation
6.218	Measuring liquid for U tube manometer, 22 cm ³
6.219	Selector switch for 4 test points
6.220	Silicone hose 3.5 x 2.0 transparent (per metre)
6.221	Pressure test nipple G 1/4" Pressure test nipple G 1/8"
6.222	Mutimeter type Amprobe 37 x R-A complete with bag
6.223	Cable black Cable red
7.	Tools
7.101	Tool set with one hexagon head screw driver each DIN 911, for cheese-head screws with inner hexagonal recess, key width -4-5-6-7-8-10-17
7.102	Tool for Monarch burners , with 1 adjustable wrench DIN 3110 key width -8/10-12/13-11/14-16/17-19/22-22/24-27/32 hexagon head screw driver 2,3/4,5, cross-slotted screw driver M5 socket wrench key width 8.
7.103	Nozzle case Strong steel case, for the housing of 64 nozzles, over-all dimensions 230 x 230 x 45 mm for 40 Fluidics nozzles
7.104	Oil suction device to fill oil line between oil tank and burner
7.105	Rubber cone for oil suction device
7.106	Extractor W5, W30-C, W40
7.107	Extractor size 1 - 8, 30 + 40, WM 10-30
7.108	Extractor size 9 - 11, 50 - 70 Extractor magnetic coupling

No.	Dénomination
6.218	Liquide de mesure pour tube U, 22 cm ³
6.219	Prises de mesure commutateur pour 4 points de mesure
6.220	Flexible silicone 3,5 x 2,0 transparent (au mètre)
6.221	Raccord pour mesure G 1/4" Raccord pour mesure G 1/8"
6.222	Multimètre type Amprobe 37 x R-A complet avec trousse de transport
6.223	Cordon de mesure sécurisé noir Cordon de mesure sécurisé rouge
7.	Outillage
7.101	Trousse d'outillage , avec 1 porte-embout 6 pans DIN 911, pour vis à 6 pans creuse, SW-4-5-6-7-8-10-17
7.102	Outillage pour brûleurs Monarch avec 1 clé à fourche DIN 3110 SW-8/10-12/13-11/14-16/17-19/22-22/24-27/32, porte-embout 6 pans 2,3/4,5, tournevis cruciforme M5, clé à douille de 8
7.103	Boîte de gicleurs Carcasse en tôle rigide pour 64 gicleurs, Dimensions ext. 230 x 230 x 45 mm (sans photo) pour 40 gicleurs Fluidics
7.104	Aspirateur fioul pour remplissage des conduites fioul entre cuve et brûleur
7.105	Cône en caoutchouc pour aspirateur fioul
7.106	Arrache-turbine W5, W30-C, W40
7.107	Arrache-turbine Gr. 1 - 8, 30 + 40, WM 10-30
7.108	Arrache-turbine Gr. 9 - 11, 50 - 70 Arrache-turbine accouplement magnétique

Nr.	Bezeichnung	Bestell-Nr. Order-No. No de commande	Preis EUR (o.MWSt.)
8.	Zubehör für BUS-Systeme W-FM 100/200		
8.1	eBUS direkt Anschlußkabel ABE eBUS / PC-Adapter Steckklemme	217 706 1251 2 743 092 743 082	
8.2	eGATE Profibus-DP Anschlußkabel ABE eBUS / PC-Adapter Steckklemme Set eGATE Profibus-DP Kopplungssoftware S7-300/-400 über eBUS	217 706 1251 2 743 092 743 082 217 706 1253 2 217 706 1259 7	
8.3	Modbus direkt Anschlußkabel RS 232 / RS 485-Adapter Netzteil Kopplungssoftware S7-300/-400 über Modbus	217 706 1260 2 716 402 710 109 217 706 1261 7	
8.4	ModGATE Profibus-DP Set ModGATE Profibus-DP Netzteil Anschlusskabel ABE 5m	217 706 1266 2 710 109 217 706 1265 2	
8.5	LON Anschlußkabel ABE RS 232 / RS 485-Adapter Babel Buster 485 Netzteil	217 706 1260 2 716 402 217 706 1281 2 710 109	









No.	Designation
8.	Accessories for BUS systems W-FM 100/200
8.1	eBUS direct Connection cable ABE eBUS / PC adapter Plug terminal
8.2	eGATE Profibus-DP Connection cable ABE eBUS / PC adapter Plug terminal Set eGATE Profibus-DP Coupling software S7-300/-400 via eBUS
8.3	Modbus direct Connection cable RS 232 / RS 485 adapter Mains adapter Coupling software S7-300/-400 via Modbus
8.4	ModGATE Profibus-DP Set ModGATE Profibus-DP Mains adapter Connection cable ABE 5m
8.5	LON Connection cable ABE RS 232 / RS 485 adapter Babel Buster 485 Mains adapter

No.	Dénomination
8.	Accessoires pour systèmes BUS W-FM 100/200
8.1	eBUS direct Câble de raccordement ABE Adaptateur eBUS / PC Connecteur de raccordement
8.2	eGATE Profibus-DP Câble de raccordement ABE Adaptateur eBUS / PC Connecteur de raccordement Set eGATE Profibus-DP Logiciel de communication S7-300/-400 via eBUS
8.3	Modbus direct Câble de raccordement Adaptateur RS 232 / RS 485 Réseau Logiciel de communication S7-300/-400 via Modbus
8.4	ModGATE Profibus-DP Set ModGATE Profibus-DP Réseau Câble de raccordement ABE 5m
8.5	LON Câble de raccordement ABE Adaptateur RS 232 / RS 485 Babel Buster 485 Réseau

Weishaupt in Ihrer Nähe?

Adressen, Telefonnummern usw.
finden sie unter www.weishaupt.de

Druck-Nr. 83021201, Mai 2012
Änderungen aller Art vorbehalten.
Nachdruck verboten.

Produkt		Beschreibung	Leistung
	W-Brenner	Die millionenfach bewährte Kompakt-Baureihe: Sparsam, zuverlässig, vollautomatisch. Öl-, Gas- und Zweistoffbrenner für Ein- und Mehrfamilienhäuser sowie Gewerbebetriebe. Als purflam Brenner wird Öl nahezu rußfrei verbrannt und NO _x -Emissionen nachhaltig reduziert.	bis 570 kW
	monarch® und Industriebrenner	Der legendäre Industriebrenner: Bewährt, langlebig, übersichtlich. Öl-, Gas- und Zweistoffbrenner für zentrale Wärmeversorgungsanlagen.	bis 10.900 kW
	multiflam® Brenner	Innovative Weishaupt-Technologie für Großbrenner: Minimale Emissionswerte besonders bei Leistungen über ein Megawatt. Öl-, Gas- und Zweistoffbrenner mit patentierter Brennstoffaufteilung.	bis 12.000 kW
	WK-Industriebrenner	Kraftpakete im Baukastensystem: Anpassungsfähig, robust, leistungsstark. Öl-, Gas- und Zweistoffbrenner für Industrieanlagen.	bis 18.000 kW
	Thermo Unit	Die Heizsysteme Thermo Unit aus Guss oder Stahl: Modern, wirtschaftlich, zuverlässig. Für die umweltschonende Beheizung von Ein- und Mehrfamilienhäusern. Brennstoff: Wahlweise Gas oder Öl.	bis 55 kW
	Thermo Condens	Die innovativen Gas-Brennwertgeräte mit SCOT-System: Effizient, schadstoffarm, vielseitig. Ideal für Wohnungen, Ein- und Mehrfamilienhäuser. Und für den großen Wärmebedarf als bodenstehende Gas-Brennwertkessel mit bis zu 1200 kW Leistung (Kaskade).	bis 1.200 kW
	Wärmepumpen	Das Wärmepumpenprogramm bietet Lösungen für die Nutzung von Wärme aus der Luft, der Erde oder dem Grundwasser. Die Systeme sind geeignet für Sanierung oder Neubau.	bis 130 kW
	Solar-Systeme	Gratisenergie von der Sonne: Perfekt abgestimmte Komponenten, innovativ, bewährt. Formschöne Flachdachkollektoren zur Heizungsunterstützung und Trinkwassererwärmung.	
	Wassererwärmer / Energiespeicher	Das attraktive Programm zur Trinkwassererwärmung umfasst klassische Wassererwärmer, die über ein Heizsystem versorgt werden und Energiespeicher, die über Solarsysteme gespeist werden können.	
	MSR-Technik / Gebäudeautomation	Vom Schaltschrank bis zur Komplettsteuerung von Gebäudetechnik – bei Weishaupt finden Sie das gesamte Spektrum moderner MSR Technik. Zukunftsorientiert, wirtschaftlich und flexibel.	